

SIGGRAPH 2000 Course Notes

Subdivision for Modeling and Animation

Organizers: Denis Zorin, New York University
Peter Schröder, Caltech

Lecturers

Denis Zorin

Media Research Laboratory
719 Broadway,rm. 1201
New York University
New York, NY 10012
net: dzorin@mrl.nyu.edu

Peter Schröder

Caltech Multi-Res Modeling Group
Computer Science Department 256-80
California Institute of Technology
Pasadena, CA 91125
net: ps@cs.caltech.edu

Tony DeRose

Studio Tools Group
Pixar Animation Studios
1001 West Cutting Blvd.
Richmond, CA 94804
net: derose@pixar.com

Leif Kobbelt

Computer Graphics Group
Max-Planck-Institute for Computer Sciences
Im Stadtwald
66123 Saarbrücken, Germany
net: kobbelt@mpi-sb.mpg.de

Adi Levin

School of Mathematics
Tel-Aviv University
69978 Tel-Aviv Israel
net: adilev@math.tau.ac.il

Wim Sweldens

Bell Laboratories, Lucent Technologies
600 Mountain Avenue
Murray Hill, NJ 07974
net: wim@lucent.com

Schedule

Morning Session: Introductory Material The morning section will focus on the foundations of subdivision, starting with subdivision curves and moving on to surfaces. We will review and compare a number of different schemes and discuss the relation between subdivision and splines. The emphasis will be on properties of subdivision most relevant for applications.

Foundations I: Basic Ideas

Peter Schröder and Denis Zorin

Foundations II: Subdivision Schemes for Surfaces

Denis Zorin

Afternoon Session: Applications and Algorithms The afternoon session will focus on applications of subdivision and the algorithmic issues practitioners need to address to build efficient, well behaving systems for modeling and animation with subdivision surfaces.

Implementing Subdivision and Multiresolution Surfaces

Denis Zorin

Combined Subdivision Schemes

Adi Levin

A Variational Approach to Subdivision

Leif Kobbelt

Parameterization, Remeshing, and Compression Using Subdivision

Wim Sweldens

Subdivision Surfaces in the Making of Geri's Game, A Bug's Life, and Toy Story 2

Tony DeRose

Lecturers' Biographies

Denis Zorin is an assistant professor at the Courant Institute of Mathematical Sciences, New York University. He received a BS degree from the Moscow Institute of Physics and Technology, a MS degree in Mathematics from Ohio State University and a PhD in Computer Science from the California Institute of Technology. In 1997-98, he was a research associate at the Computer Science Department of Stanford University. His research interests include multiresolution modeling, the theory of subdivision, and applications of subdivision surfaces in Computer Graphics. He is also interested in perceptually-based computer graphics algorithms. He has published several papers in Siggraph proceedings.

Peter Schröder is an associate professor of computer science at Caltech, Pasadena, where he directs the Multi-Res Modeling Group. He received a Master's degree from the MIT Media Lab and a PhD from Princeton University. For the past 8 years his work has concentrated on exploiting wavelets and multiresolution techniques to build efficient representations and algorithms for many fundamental computer graphics problems. His current research focuses on subdivision as a fundamental paradigm for geometric modeling and rapid manipulation of large, complex geometric models. The results of his work have been published in venues ranging from Siggraph to special journal issues on wavelets and WIRED magazine, and he is a frequent consultant to industry, and was recently recognized when he was named a Packard Foundation Fellow.

Tony DeRose is currently a member of the Tools Group at Pixar Animation Studios. He received a BS in Physics in 1981 from the University of California, Davis; in 1985 he received a Ph.D. in Computer Science from the University of California, Berkeley. He received a Presidential Young Investigator award from the National Science Foundation in 1989. In 1995 he was selected as a finalist in the software category of the Discover Awards for Technical Innovation.

From September 1986 to December 1995 Dr. DeRose was a Professor of Computer Science and Engineering at the University of Washington. From September 1991 to August 1992 he was on sabbatical leave at the Xerox Palo Alto Research Center and at Apple Computer. He has served on various technical program committees including SIGGRAPH, and from 1988 through 1994 was an associate editor of ACM Transactions on Graphics.

His research has focused on mathematical methods for surface modeling, data fitting, and more recently, in the use of multiresolution techniques. Recent projects include object acquisition from laser range data and multiresolution/wavelet methods for high-performance computer graphics.

Leif Kobbelt is a senior researcher at the Max-Planck-Institute for computer sciences in Saarbrücken, Germany. His major research interests include multiresolution and free-form modeling as well as the efficient handling of polygonal mesh data. He received his habilitation degree from the University of Erlangen, Germany where he worked from 1996 to 1999. In 1995/96 he spent one post-doc year at the University of Wisconsin, Madison. He received his master's (1992) and Ph.D. (1994) degrees from the University of Karlsruhe, Germany. During the last 7 years he did research in various fields of computer graphics and CAGD.

Adi Levin has recently completed a PhD in Applied Mathematics at Tel-Aviv University. He received a BS degree in Applied Mathematics from Tel-Aviv university. In 1999, he was a visiting researcher at the Caltech Department of Computer Science. His research interests include surface representation for Computer Aided Geometric Design, the theory and applications of Subdivision methods and geometric algorithms for Computer Graphics and CAGD. He has published papers in Siggraph'99 and Siggraph'2000.

Wim Sweldens is a researcher at Bell Laboratories, Lucent Technologies. His work concerns the generalization of signal processing techniques to complex geometries. He is the inventor of the "lifting scheme," a technique for building wavelets and multiresolution transforms on irregularly sampled data and surfaces in 3D. More recently he worked on parameterization, remeshing, and compression of subdivision surfaces. He has lectured widely on the use of wavelets and subdivision in computer graphics and participated in three previous SIGGRAPH courses. MIT's Technology Review recently selected him as one of a 100 top young technological innovators. He is the founder and editor-in-chief on the Wavelet Digest.

Contents

1	Introduction	13
2	Foundations I: Basic Ideas	17
2.1	The Idea of Subdivision	18
2.2	Review of Splines	22
2.2.1	Piecewise Polynomial Curves	22
2.2.2	Definition of B-Splines	23
2.2.3	Refinability of B-splines	25
2.2.4	Refinement for Spline Curves	27
2.2.5	Subdivision for Spline Curves	29
2.3	Subdivision as Repeated Refinement	30
2.3.1	Discrete Convolution	30
2.3.2	Convergence of Subdivision	32
2.3.3	Summary	35
2.4	Analysis of Subdivision	35
2.4.1	Invariant Neighborhoods	36
2.4.2	Eigen Analysis	40
2.4.3	Convergence of Subdivision	42
2.4.4	Invariance under Affine Transformations	42
2.4.5	Geometric Behavior of Repeated Subdivision	43
2.4.6	Size of the Invariant Neighborhood	45
2.4.7	Summary	45

3	Subdivision Surfaces	47
3.1	Subdivision Surfaces: an Example	48
3.2	Natural Parameterization of Subdivision Surfaces	50
3.3	Subdivision Matrix	53
3.4	Smoothness of Surfaces	56
3.4.1	C^1 -continuity and Tangent Plane Continuity	56
3.5	Analysis of Subdivision Surfaces	57
3.5.1	C^1 -continuity of Subdivision away from Extraordinary Vertices	58
3.5.2	Smoothness Near Extraordinary Vertices	60
3.5.3	Characteristic Map	61
3.6	Piecewise-smooth surfaces and subdivision	63
4	Subdivision Zoo	65
4.1	Overview of Subdivision Schemes	65
4.1.1	Notation and Terminology	68
4.2	Loop Scheme	69
4.3	Modified Butterfly Scheme	72
4.4	Catmull-Clark Scheme	75
4.5	Kobbelt Scheme	78
4.6	Doo-Sabin and Midedge Schemes	79
4.7	Uniform Approach to Quadrilateral Subdivision	80
4.8	Comparison of Schemes	84
4.8.1	Comparison of Dual Quadrilateral Schemes	86
4.9	Tilings	89
4.10	Limitations of Stationary Subdivision	92
5	Implementing Subdivision and Multiresolution Surfaces	105
5.1	Data Structures for Subdivision	105
5.1.1	Representing Arbitrary Meshes	105
5.1.2	Hierarchical Meshes: Arrays vs. Trees	107
5.1.3	Implementations	109
5.2	Multiresolution Mesh Editing	117
6	Combined Subdivision Schemes	

7 Parameterization, Remeshing, and Compression Using Subdivision

8 Interpolatory Subdivision for Quad Meshes

9 A Variational Approach to Subdivision

10 Subdivision Surfaces in the Making of Geri's Game, A Bug's Life, and Toy Story 2

Chapter 1

Introduction

Twenty years ago the publication of the papers by Catmull and Clark [4] and Doo and Sabin [5] marked the beginning of subdivision for surface modeling. Now we can regularly see subdivision used in movie production (e.g., *Geri's Game*, *A Bug's Life*, and *Toy Story 2*), appear as a first class citizen in commercial modelers and in be a core technology in game engines.

The basic ideas behind subdivision are very old indeed and can be traced as far back as the late 40s and early 50s when G. de Rham used “corner cutting” to describe smooth curves. It was only recently though that subdivision surfaces have found their way into wide application in computer graphics and computer assisted geometric design (CAGD). One reason for this development is the importance of multiresolution techniques to address the challenges of ever larger and more complex geometry: subdivision is intricately linked to multiresolution and traditional mathematical tools such as wavelets.

Constructing surfaces through subdivision elegantly addresses many issues that computer graphics practitioners are confronted with

- **Arbitrary Topology:** Subdivision generalizes classical spline patch approaches to arbitrary topology. This implies that there is no need for trim curves or awkward constraint management between patches.
- **Scalability:** Because of its recursive structure, subdivision naturally accommodates level-of-detail rendering and adaptive approximation with error bounds. The result are algorithms which can make the best of limited hardware resources, such as those found on low end PCs.
- **Uniformity of Representation:** Much of traditional modeling uses either polygonal meshes or spline patches. Subdivision spans the spectrum between these two extremes. Surfaces can behave

as if they are made of patches, or they can be treated as if consisting of many small polygons.

- **Numerical Stability:** The meshes produced by subdivision have many of the nice properties finite element solvers require. As a result subdivision representations are also highly suitable for many numerical simulation tasks which are of importance in engineering and computer animation settings.
- **Code Simplicity:** Last but not least the basic ideas behind subdivision are simple to implement and execute very efficiently. While some of the deeper mathematical analyses can get quite involved this is of little concern for the final implementation and runtime performance.

In this course and its accompanying notes we hope to convince you, the reader, that in fact the above claims are true!

The main focus of our notes will be on covering the basic principles behind subdivision; how subdivision rules are constructed; to indicate how their analysis is approached; and, most importantly, to address some of the practical issues in turning these ideas and techniques into real applications. As an extra bonus in this year's edition of the subdivision course we are including code for triangle and quadrilateral based subdivision schemes.

The following 2 chapters will be devoted to understanding the basic principles. We begin with some examples in the curve, i.e., 1D setting. This simplifies the exposition considerably, but still allows us to introduce all the basic ideas which are equally applicable in the surface setting. Proceeding to the surface setting we cover a variety of different subdivision schemes and their properties.

With these basics in place we proceed to the second, applications oriented part, covering algorithms and implementations addressing

- **Implementing Subdivision and Multiresolution Surfaces:** Subdivision can model smooth surfaces, but in many applications one is interested in surfaces which carry details at many levels of resolution. Multiresolution mesh editing extends subdivision by including detail offsets at every level of subdivision, unifying patch based editing with the flexibility of high resolution polyhedral meshes. In this part, we will focus on implementation concerns common for subdivision and multiresolution surfaces based on subdivision.
- **Combined Subdivision Schemes:** This section will present a class of subdivision schemes called "Combined Subdivision Schemes." These are subdivision schemes whose limit surfaces can satisfy prescribed boundary conditions. Every combined subdivision scheme consists of an ordinary subdivision scheme that operates in the interior of the mesh, and special rules that operate near

tagged edges of the mesh and take into consideration the given boundary conditions. The limit surfaces are smooth and they satisfy the boundary conditions. Particular examples of combined subdivision schemes will be presented and their applications discussed.

- **Parameterization, Remeshing, and Compression Using Subdivision:** Subdivision methods typically use a simple mesh refinement procedure such as triangle or quadrilateral quadrisection. Iterating this refinement step starting from a coarse, arbitrary connectivity control mesh generates semi-regular meshes. However, meshes coming from scanning devices are fully irregular and do not have semi-regular connectivity. In order to use multiresolution and subdivision based algorithms for such meshes they first need to be remeshed onto semi-regular connectivity. In this section we show how to use mesh simplification to build a smooth parameterization of dense irregular connectivity meshes and to convert them to semi-regular connectivity. The method supports both fully automatic operation as well as user defined point and edge constraints. We also show how semi-regular meshes can be compressed using a wavelet and zero-tree based algorithm.
- **A Variational Approach to Subdivision:** Surfaces generated using subdivision have certain orders of continuity. However, it is well known from geometric modeling that high quality surfaces often require additional optimization (fairing). In the variational approach to subdivision, refined meshes are not prescribed by static rules, but are chosen so as to minimize some energy functional. The approach combines the advantages of subdivision (arbitrary topology) with those of variational design (high quality surfaces). This section will describe the theory of variational subdivision and highly efficient algorithms to construct fair surfaces.
- **Subdivision Surfaces in the Making of Geri's Game, A Bug's Life, and Toy Story 2:** Geri's Game is a 3.5 minute computer animated film that Pixar completed in 1997. The film marks the first time that Pixar has used subdivision surfaces in a production. In fact, subdivision surfaces were used to model virtually everything that moves. Subdivision surfaces went on to play a major role the feature films 'A Bug's Life' and 'Toy Story 2' from Disney/Pixar. This section will describe what led Pixar to use subdivision surfaces, discuss several issues that were encountered along the way, and present several of the solutions that were developed.

Beyond these Notes

One of the reasons that subdivision is enjoying so much interest right now is that it is very easy to implement and very efficient. In fact it is used in many computer graphics courses at universities as a

homework exercise. The mathematical theory behind it is very beautiful, but also very subtle and at times technical. We are not treating the mathematical details in these notes, which are primarily intended for the computer graphics practitioners. However, for those interested in the theory there are many pointers to the literature.

These notes as well as other materials such as presentation slides, applets and code are available on the web at <http://www.mrl.nyu.edu/dzorin/sig00course/> and all readers are encouraged to explore the online resources.

Chapter 2

Foundations I: Basic Ideas

Peter Schröder, Caltech

In this chapter we focus on the 1D case to introduce all the basic ideas and concepts before going on to the 2D setting. Examples will be used throughout to motivate these ideas and concepts. We begin initially with an example from interpolating subdivision, before talking about splines and their subdivision generalizations.

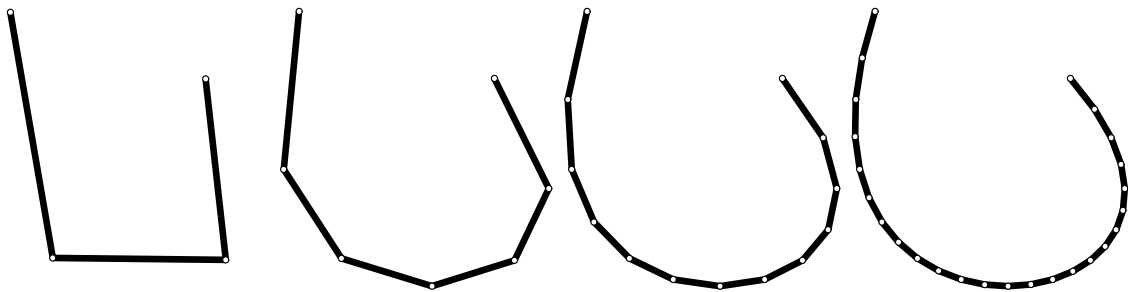

Figure 2.1: *Example of subdivision for curves in the plane. On the left 4 points connected with straight line segments. To the right of it a refined version: 3 new points have been inserted “inbetween” the old points and again a piecewise linear curve connecting them is drawn. After two more steps of subdivision the curve starts to become rather smooth.*

2.1 The Idea of Subdivision

We can summarize the basic idea of subdivision as follows:

Subdivision defines a smooth curve or surface as the limit of a sequence of successive refinements.

Of course this is a rather loose description with many details as yet undetermined, but it captures the essence.

Figure 2.1 shows an example in the case of a curve connecting some number of initial points in the plane. On the left we begin with 4 points connected through straight line segments. Next to it is a refined version. This time we have the original 4 points and additionally 3 more points “inbetween” the old points. Repeating the process we get a smoother looking piecewise linear curve. Repeating once more the curve starts to look quite nice already. It is easy to see that after a few more steps of this procedure the resulting curve would be as well resolved as one could hope when using finite resolution such as that offered by a computer monitor or a laser printer.

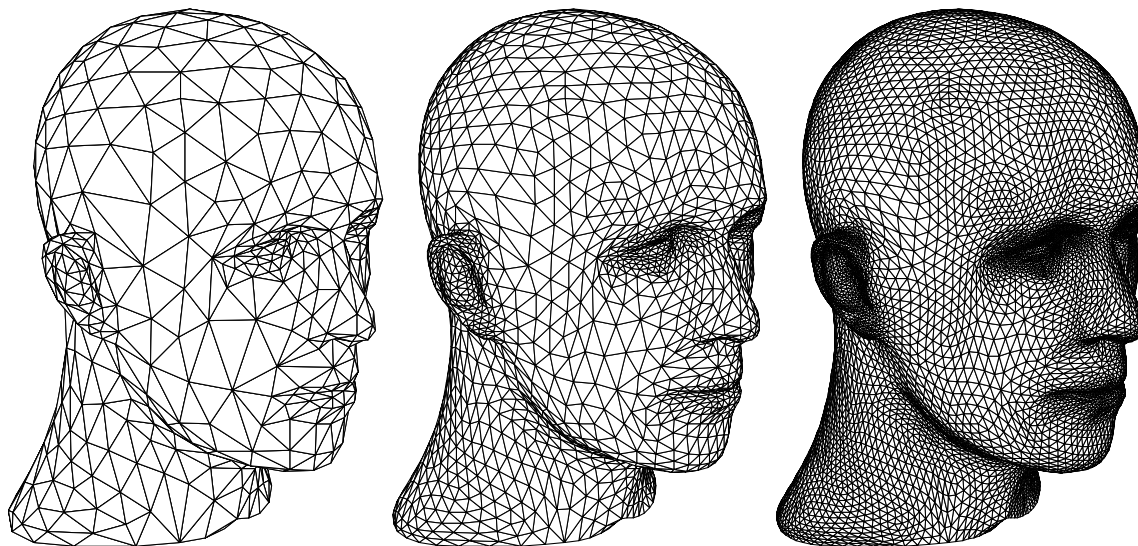

Figure 2.2: Example of subdivision for a surface, showing 3 successive levels of refinement. On the left an initial triangular mesh approximating the surface. Each triangle is split into 4 according to a particular subdivision rule (middle). On the right the mesh is subdivided in this fashion once again.

An example of subdivision for surfaces is shown in Figure 2.2. In this case each triangle in the original mesh on the left is split into 4 new triangles quadrupling the number of triangles in the mesh. Applying the same subdivision rule once again gives the mesh on the right.

Both of these examples show what is known as interpolating subdivision. The original points remain undisturbed while new points are inserted. We will see below that splines, which are generally not interpolating, can also be generated through subdivision. Albeit in that case new points are inserted *and* old points are moved in each step of subdivision.

How were the new points determined? One could imagine many ways to decide where the new points should go. Clearly, the shape and smoothness of the resulting curve or surface depends on the chosen rule. Here we list a number of properties that we might look for in such rules:

- **Efficiency:** the location of new points should be computed with a small number of floating point operations;
- **Compact support:** the region over which a point influences the shape of the final curve or surface should be small and finite;
- **Local definition:** the rules used to determine where new points go should not depend on “far away” places;
- **Affine invariance:** if the original set of points is transformed, e.g., translated, scaled, or rotated, the resulting shape should undergo the same transformation;
- **Simplicity:** determining the rules themselves should preferably be an offline process and there should only be a small number of rules;
- **Continuity:** what kind of properties can we prove about the resulting curves and surfaces, for example, are they differentiable?

For example, the rule used to construct the curve in Figure 2.1 computed new points by taking a weighted average of nearby old points: two to the left and two to the right with weights $1/16(-1, 9, 9, -1)$ respectively (we are ignoring the boundaries for the moment). It is very efficient since it only involves 4 multiplies and 3 adds (per coordinate); has compact support since only 2 neighbors on either side are involved; its definition is local since the weights do not depend on anything in the arrangement of the points; the rule is affinely invariant since the weights used sum to 1; it is very simple since only 1 rule is used (there is one more rule if one wants to account for the boundaries); finally the limit curves one gets by repeating this process ad infinitum are C^1 .

Before delving into the details of how these rules are derived we quickly compare subdivision to other possible modeling approaches for smooth surfaces: traditional splines, implicit surfaces, and variational surfaces.

1. **Efficiency:** Computational cost is an important aspect of a modeling method. Subdivision is easy to implement and is computationally efficient. Only a small number of neighboring old points are used in the computation of the new points. This is similar to knot insertion methods found in spline modeling, and in fact many subdivision methods are simply generalization of knot insertion. On the other hand implicit surfaces, for example, are much more costly. An algorithm such as marching cubes is required to generate the polygonal approximation needed for rendering. Variational surfaces can be even worse: a global optimization problem has to be solved each time the surface is changed.
2. **Arbitrary topology:** It is desirable to build surfaces of arbitrary topology. This is a great strength of implicit modeling methods. They can even deal with *changing* topology during a modeling session. Classic spline approaches on the other hand have great difficulty with control meshes of arbitrary topology. Here, “arbitrary topology” captures two properties. First, the topological genus of the mesh and associated surface can be arbitrary. Second, the structure of the graph formed by the edges and vertices of the mesh can be arbitrary; specifically, each vertex may be of arbitrary degree.

These last two aspects are related: if we insist on all vertices having degree 4 (for quadrilateral) control meshes, or having degree 6 (for triangular) control meshes, the Euler characteristic for a planar graph tells us that such meshes can only be constructed if the overall topology of the shape is that of the infinite plane, the infinite cylinder, or the torus. Any other shape, for example a sphere, cannot be built from a quadrilateral (triangular) control mesh having vertices of degree 4 (6).

When rectangular spline patches are used in arbitrary control meshes, enforcing higher order continuity at extraordinary vertices becomes difficult and considerably increases the complexity of the representation (see Figure 2.3 for an example of points not having valence 4). Implicit surfaces can be of arbitrary topological genus, but the genus, precise location, and connectivity of a surface are typically difficult to control. Variational surfaces can handle arbitrary topology better than any other representation, but the computational cost can be high. Subdivision can handle arbitrary topology quite well without losing efficiency; this is one of its key advantages. Historically subdivision arose when researchers were looking for ways to address the arbitrary topology modeling challenge for splines.

3. **Surface features:** Often it is desirable to control the shape and size of features, such as creases, grooves, or sharp edges. Variational surfaces provide the most flexibility and exact control for cre-

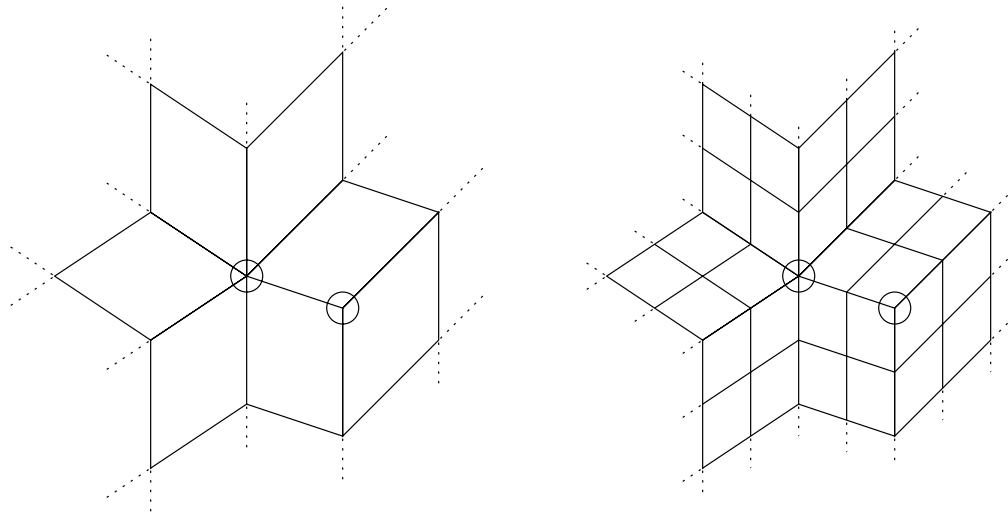

Figure 2.3: A mesh with two extraordinary vertices, one with valence 6 the other with valence 3. In the case of quadrilateral patches the standard valence is 4. Special efforts are required to guarantee high order of continuity between spline patches meeting at the extraordinary points; subdivision handles such situations in a natural way.

ating features. Implicit surfaces, on the other hand, are very difficult to control, since all modeling is performed indirectly and there is much potential for undesirable interactions between different parts of the surface. Spline surfaces allow very precise control, but it is computationally expensive and awkward to incorporate features, in particular if one wants to do so in arbitrary locations. Subdivision allows more flexible controls than is possible with splines. In addition to choosing locations of control points, one can manipulate the coefficients of subdivision to achieve effects such as sharp creases or control the behavior of the boundary curves.

4. **Complex geometry:** For interactive applications, efficiency is of paramount importance. Because subdivision is based on repeated refinement it is very straightforward to incorporate ideas such as level-of-detail rendering and compression for the internet. During interactive editing locally adaptive subdivision can generate just enough refinement based on geometric criteria, for example. For applications that only require the visualization of fixed geometry, other representations, such as progressive meshes, are likely to be more suitable.

Since most subdivision techniques used today are based upon and generalize splines we begin with a quick review of some basic facts of splines which we will need to understand the connection between splines and subdivision.

2.2 Review of Splines

2.2.1 Piecewise Polynomial Curves

Splines are piecewise polynomial curves of some chosen degree. In the case of cubic splines, for example, each polynomial segment of the curve can be written as

$$\begin{aligned}x(t) &= a_3^i t^3 + a_2^i t^2 + a_1^i t + a_0^i \\y(t) &= b_3^i t^3 + b_2^i t^2 + b_1^i t + b_0^i,\end{aligned}$$

where (\mathbf{a}, \mathbf{b}) are constant coefficients which control the shape of the curve over the associated segment. This representation uses monomials (t^3, t^2, t^1, t^0) , which are restricted to the given segment, as basis functions.

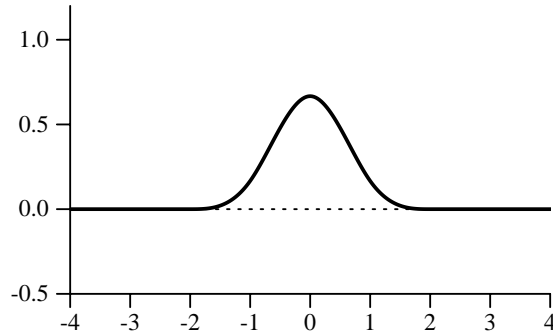

Figure 2.4: Graph of the cubic B-spline. It is zero for the independent parameter outside the interval $[-2, 2]$.

Typically one wants the curve to have some order of continuity along its entire length. In the case of cubic splines one would typically want C^2 continuity. This places constraints on the coefficients (\mathbf{a}, \mathbf{b}) of neighboring curve segments. Manipulating the shape of the desired curves through these coefficients, while maintaining the constraints, is very awkward and difficult. Instead of using monomials as the basic building blocks, we can write the spline curve as a linear combination of shifted *B-splines*, each with a coefficient known as a *control point*

$$\begin{aligned}x(t) &= \sum x_i B(t - i) \\y(t) &= \sum y_i B(t - i).\end{aligned}$$

The new basis function $B(t)$ is chosen in such a way that the resulting curves are always continuous and that the influence of a control point is local. One way to ensure higher order continuity is to use basis

functions which are differentiable of the appropriate order. Since polynomials themselves are infinitely smooth, we only have to make sure that derivatives match at the points where two polynomial segments meet. The higher the degree of the polynomial, the more derivatives we are able to match. We also want the influence of a control point to be maximal over a region of the curve which is close to the control point. Its influence should decrease as we move away along the curve and disappear entirely at some distance. Finally, we want the basis functions to be piecewise polynomial so that we can represent any piecewise polynomial curve of a given degree with the associated basis functions. B-splines are constructed to exactly satisfy these requirements (for a cubic B-spline see Figure 2.4) and in a moment we will show how they are constructed.

The advantage of using this representation rather than the earlier one of monomials, is that the continuity conditions at the segment boundaries are already “hardwired” into the basis functions. No matter how we move the control points, the spline curve will always maintain its continuity, for example, C^2 in the case of cubic B-splines.¹ Furthermore, moving a control point has the greatest effect on the part of the curve near that control point, and no effect whatsoever beyond a certain range. These features make B-splines a much more appropriate tool for modeling piecewise polynomial curves.

Note: When we talk about curves, it is important to distinguish the curve itself and the graphs of the coordinate functions of the curve, which can also be thought of as curves. For example, a curve can be described by equations $x(t) = \sin(t)$, $y(t) = \cos(t)$. The curve itself is a circle, but the coordinate functions are sinusoids. For the moment, we are going to concentrate on representing the coordinate functions.

2.2.2 Definition of B-Splines

There are many ways to derive B-splines. Here we choose repeated convolution, since we can see from it directly how splines can be generated through subdivision.

We start with the simplest case: piecewise constant coordinate functions. Any piecewise constant function can be written as

$$x(t) = \sum x_i B_0^i(t),$$

¹The differentiability of the basis functions guarantees the differentiability of the coordinate functions of the curve. However, it does not guarantee the geometric smoothness of the curve. We will return to this distinction in our discussion of subdivision surfaces.

where $B_0(t)$ is the box function defined as

$$\begin{aligned} B_0(t) &= 1 \quad \text{if } 0 \leq t < 1 \\ &= 0 \quad \text{otherwise,} \end{aligned}$$

and the functions $B_0^i(t) = B_0(t - i)$ are translates of $B_0(t)$. Furthermore, let us represent the continuous convolution of two functions $f(t)$ and $g(t)$ with

$$(f \otimes g)(t) = \int f(s)g(t-s)ds.$$

A B-spline basis function of degree n can be obtained by convolving the basis function of degree $n - 1$ with the box $B_0(t)$.² For example, the B-spline of degree 1 is defined as the convolution of $B_0(t)$ with itself

$$B_1(t) = \int B_0(s)B_0(t-s)ds.$$

Graphically (see Figure 2.5), this convolution can be evaluated by sliding one box function along the coordinate axis from minus to plus infinity while keeping the second box fixed. The value of the convolution for a given position of the moving box is the area under the product of the boxes, which is just the length of the interval where both boxes are non-zero. At first the two boxes do not have common support. Once the moving box reaches 0, there is a growing overlap between the supports of the graphs. The value of the convolution grows with t until $t = 1$. Then the overlap starts decreasing, and the value of the convolution decreases down to zero at $t = 2$. The function $B_1(t)$ is the linear hat function as shown in Figure 2.5.

We can compute the B-spline of degree 2 convolving $B_1(t)$ with the box $B_0(t)$ again

$$B_2(t) = \int B_1(s)B_0(t-s)ds.$$

In this case, the resulting curve consists of three quadratic segments defined on intervals $(0, 1)$, $(1, 2)$ and $(2, 3)$. In general, by convolving l times, we can get a B-spline of degree l

$$B_l(t) = \int B_{l-1}(s)B_0(t-s)ds.$$

Defining B-splines in this way a number of important properties immediately follow. The first concerns the continuity of splines

²The *degree* of a polynomial is the highest order exponent which occurs, while the *order* counts the number of coefficients and is 1 larger. For example, a cubic curve is of degree 3 and order 4.

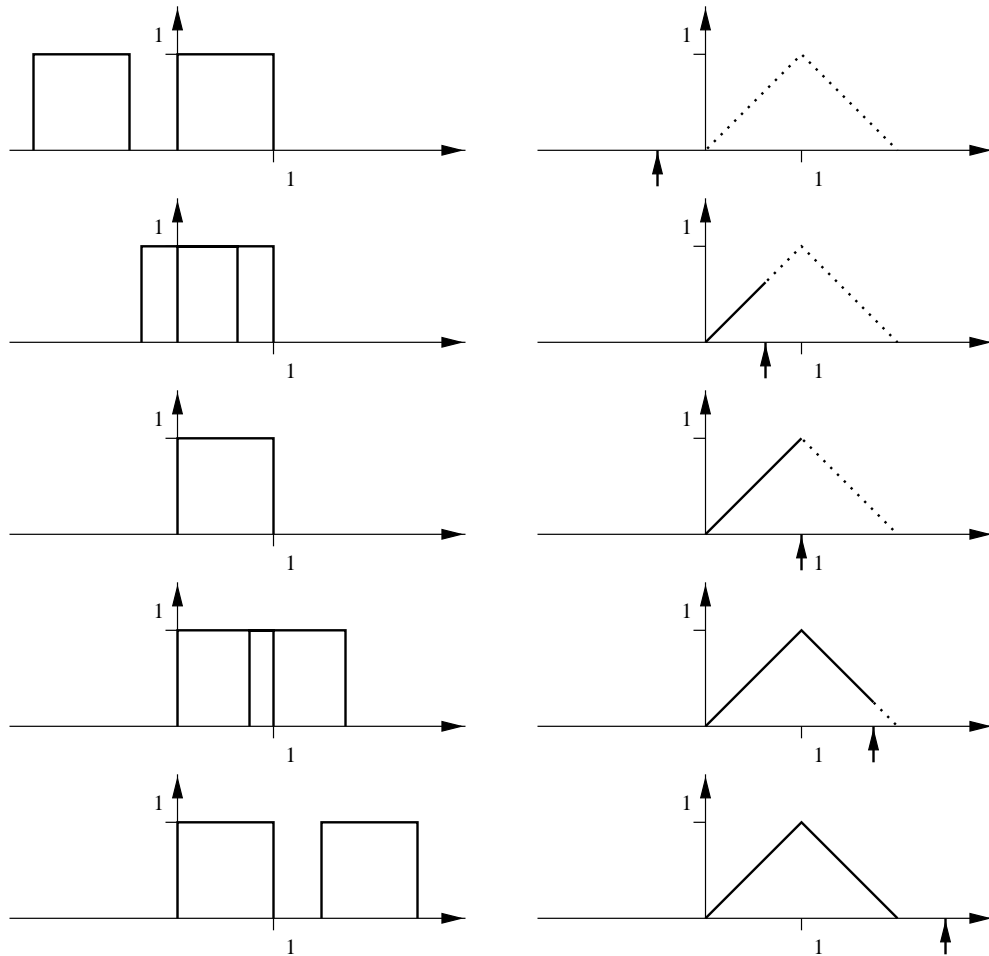

Figure 2.5: The definition of degree 1 B-Spline $B_1(t)$ (right side) through convolution of $B_0(t)$ with itself (left side).

Theorem 1 If $f(t)$ is C^k -continuous, then $(B_0 \otimes f)(t)$ is C^{k+1} -continuous.

This is a direct consequence of convolution with a box function. From this it follows that the B-spline of degree n is C^{n-1} continuous because the B-spline of degree 1 is C^0 -continuous.

2.2.3 Refinability of B-splines

Another remarkable property of B-splines is that they obey a *refinement equation*. This is the key observation to connect splines and subdivision. The refinement equation for B-splines of degree l is

given by

$$B_l(t) = \frac{1}{2^l} \sum_{k=0}^{l+1} \binom{l+1}{k} B_l(2t - k). \quad (2.1)$$

In other words, the B-spline of degree l can be written as a linear combination of *translated* (k) and *dilated* ($2t$) copies of itself. For a function to be refinable in this way is a rather special property. As an example of the above equation at work consider the hat function shown in Figure 2.5. It is easy to see that it can be written as a linear combination of dilated hat functions with weights $(1/2, 1, 1/2)$ respectively.

The property of refinability is the key to subdivision and so we will take a moment to prove it. We start by observing that the box function, i.e., the B-spline of degree 0 can be written in terms of dilates and translates of itself

$$B_0(t) = B_0(2t) + B_0(2t - 1), \quad (2.2)$$

which is easily checked by direct inspection. Recall that we defined the B-spline of degree l as

$$B_l(t) = \bigotimes_{i=0}^l B_0(t) = \bigotimes_{i=0}^l (B_0(2t) + B_0(2t - 1)) \quad (2.3)$$

This expression can be “multiplied” out by using the following properties of convolution for functions $f(t)$, $g(t)$, and $h(t)$

$$\begin{aligned} f(t) \otimes (g(t) + h(t)) &= f(t) \otimes g(t) + f(t) \otimes h(t) && \text{linearity} \\ f(t - i) \otimes g(t - k) &= m(t - i - k) && \text{time shift} \\ f(2t) \otimes g(2t) &= \frac{1}{2}m(2t) && \text{time scaling} \end{aligned}$$

where $m(t) = f(t) \otimes g(t)$. These properties are easy to check by substituting the definition of convolution and amount to simple change of variables in the integration.

For example, in the case of B_1 we get

$$\begin{aligned} B_1(t) &= B_0(t) \otimes B_0(t) \\ &= (B_0(2t) + B_0(2t - 1)) \otimes (B_0(2t) + B_0(2t - 1)) \\ &= B_0(2t) \otimes B_0(2t) + B_0(2t) \otimes B_0(2t - 1) + B_0(2t - 1) \otimes B_0(2t) + B_0(2t - 1) \otimes B_0(2t - 1) \\ &= \frac{1}{2}B_1(2t) + \frac{1}{2}B_1(2t - 1) + \frac{1}{2}B_1(2t - 1) + \frac{1}{2}B_1(2t - 1 - 1) \\ &= \frac{1}{2}(B_1(2t) + 2B_1(2t - 1) + B_1(2t - 2)) \\ &= \frac{1}{2^1} \sum_{k=0}^2 \binom{2}{k} B_1(2t - k). \end{aligned}$$

The general statement for B-splines of degree l now follows from the binomial theorem

$$(x+y)^{l+1} = \sum_{k=0}^{l+1} \binom{l+1}{k} x^{l+1-k} y^k,$$

with $B_0(2t)$ in place of x and $B_0(2t-1)$ in place of y .

2.2.4 Refinement for Spline Curves

With this machinery in hand let's revisit spline curves. Let

$$\gamma(t) = \begin{bmatrix} x(t) \\ y(t) \end{bmatrix} = \sum_i p_i B_l^i(t)$$

be such a spline curve of degree l with control points $(x_i, y_i)^T = p_i \in \mathbf{R}^2$. Since we don't want to worry about boundaries for now we leave the index set i unspecified. We will also drop the subscript l since the degree, whatever it might be, is fixed for all our examples. Due to the definition of $B^i(t) = B(t-i)$ each control point exerts influence over a small part of the curve with parameter values $t \in [i, i+l]$.

Now consider \mathbf{p} , the vector of control points of a given curve:

$$\mathbf{p} = \begin{bmatrix} \vdots \\ p_{-2} \\ p_{-1} \\ p_0 \\ p_1 \\ p_2 \\ \vdots \end{bmatrix}$$

and the vector $\mathbf{B}(t)$, which has as its elements the translates of the function B as defined above

$$\mathbf{B}(t) = \left[\dots \quad B(t+2) \quad B(t+1) \quad B(t) \quad B(t-1) \quad B(t-2) \quad \dots \right].$$

In this notation we can denote our curve as $\mathbf{B}(t)\mathbf{p}$.

Using the refinement relation derived earlier, we can rewrite each of the elements of \mathbf{B} in terms of its dilates

$$\mathbf{B}(2t) = \left[\dots \quad B(2t+2) \quad B(2t+1) \quad B(2t) \quad B(2t-1) \quad B(2t-2) \quad \dots \right],$$

using a matrix S to encode the refinement equations

$$\mathbf{B}(t) = \mathbf{B}(2t)S.$$

The entries of S are given by Equation 2.1

$$S_{2i+k,i} = s_k = \frac{1}{2^l} \binom{l+1}{k}.$$

The only non-zero entries in each column are the weights of the refinement equation, while successive columns are copies of one another save for a shift down by two rows.

We can use this relation to rewrite $\gamma(t)$

$$\gamma(t) = \mathbf{B}(t)\mathbf{p} = \mathbf{B}(2t)S\mathbf{p}.$$

It is still the same curve, but described with respect to dilated B-splines, i.e., B-splines whose support is half as wide and which are spaced twice as dense. We performed a change from the old basis $\mathbf{B}(t)$ to the new basis $\mathbf{B}(2t)$ and concurrently changed the old control points \mathbf{p} to the appropriate new control points $S\mathbf{p}$. This process can be repeated

$$\begin{aligned} \gamma(t) &= \mathbf{B}(t)\mathbf{p}^0 \\ &= \mathbf{B}(2t)\mathbf{p}^1 = \mathbf{B}(2t)S\mathbf{p}^0 \\ &\quad \vdots \\ &= \mathbf{B}(2^j t)\mathbf{p}^j = \mathbf{B}(2^j t)S^j\mathbf{p}^0, \end{aligned}$$

from which we can define the relationship between control points at different levels of subdivision

$$\mathbf{p}^{j+1} = S\mathbf{p}^j,$$

where S is our infinite subdivision matrix.

Looking more closely at one component, i , of our control points we see that

$$p_i^{j+1} = \sum_l S_{i,l} p_l^j.$$

To find out exactly which s_k is affecting which term, we can divide the above into odd and even entries. For the odd entries we have

$$p_{2i+1}^{j+1} = \sum_l S_{2i+1,l} p_l^j = \sum_l s_{2(i-l)+1} p_l^j$$

and for the even entries we have

$$p_{2i}^{j+1} = \sum_l S_{2i,l} p_l^j = \sum_l s_{2(i-l)} p_l^j.$$

From which we essentially get two different subdivision rules one for the new *even* control points of the curve and one for the new *odd* control points. As examples of the above, let us consider two concrete cases. For piecewise linear subdivision, the basis functions are hat functions. The odd coefficients are $\frac{1}{2}$ and $\frac{1}{2}$, and a lone 1 for the even point. For cubic splines the odd coefficients turn out to be $\frac{1}{2}$ and $\frac{1}{2}$, while the even coefficients are $\frac{1}{8}$, $\frac{6}{8}$, and $\frac{1}{8}$.

Another way to look at the distinction between even and odd is to notice that odd points at level $j + 1$ are newly inserted, while even points at level $j + 1$ correspond directly to the old points from level j . In the case of linear splines the even points are in fact the *same* at level $j + 1$ as they were at level j . Subdivision schemes that have this property will later be called *interpolating*, since points, once they have been computed, will never move again. In contrast to this consider cubic splines. In that case even points at level $j + 1$ are local averages of points at level j so that $p_{2i}^{j+1} \neq p_i^j$. Schemes of this type will later be called *approximating*.

2.2.5 Subdivision for Spline Curves

In the previous section we saw that we can refine the control point sequence for a given spline by multiplying the control point vector \mathbf{p} by the matrix S , which encodes the refinement equation for the B-spline used in the definition of the curve. What happens if we keep repeating this process over and over, generating ever denser sets of control points? It turns out the control point sequence converges to the actual spline curve. The speed of convergence is geometric, which is to say that the difference between the curve and its control points decreases by a constant factor on every subdivision step. Loosely speaking this means that the actual curve is hard to distinguish from the sequence of control points after only a few subdivision steps.

We can turn this last observation into an algorithm and the core of the subdivision paradigm. Instead of drawing the curve itself on the screen we draw the control polygon, i.e., the piecewise linear curve through the control points. Applying the subdivision matrix to the control points defines a sequence of piecewise linear curves which quickly converge to the spline curve itself.

In order to make these observations more precise we need to introduce a little more machinery in the next section.

2.3 Subdivision as Repeated Refinement

2.3.1 Discrete Convolution

The coefficients s_k of the B-spline refinement equation can also be derived from another perspective, namely discrete convolution. This approach mimics closely the definition of B-splines through continuous convolution. Using this machinery we can derive and check many useful properties of subdivision by looking at simple polynomials.

Recall that the generating function of a sequence a_k is defined as

$$A(z) = \sum_k a_k z^k,$$

where $A(z)$ is the z -transform of the sequence a_k . This representation is closely related to the discrete Fourier transform of a sequence by restricting the argument z to the unit circle, $z = \exp(i\theta)$. For the case of two coefficient sequences a_k and b_k their convolution is defined as

$$c_k = (a \otimes b)_k = \sum_n a_{k-n} b_n.$$

In terms of generating functions this can be stated succinctly as

$$C(z) = A(z)B(z),$$

which comes as no surprise since convolution in the time domain is multiplication in the Fourier domain.

The main advantage of generating functions, and the reason why we use them here, is that manipulations of sequences can be turned into simple operations on the generating functions. A very useful example of this is the next observation. Suppose we have two functions that each satisfy a refinement equation

$$\begin{aligned} f(t) &= \sum_k a_k f(2t - k) \\ g(t) &= \sum_k b_k g(2t - k). \end{aligned}$$

In that case the convolution $h = f \otimes g$ of f and g also satisfies a refinement equation

$$h(t) = \sum_k c_k h(2t - k),$$

whose coefficients c_k are given by the convolution of the coefficients of the individual refinement equations

$$c_k = \frac{1}{2} \sum_i a_{k-i} b_i.$$

With this little observation we can quickly find the refinement equation, and thus the coefficients of the subdivision matrix S , by repeated multiplication of generating functions. Recall that the box function $B_0(t)$ satisfies the refinement equation $B_0(t) = B_0(2t) + B_0(2t - 1)$. The generating function of this refinement equation is $A(z) = (1 + z)$ since the only non-zero terms of the refinement equation are those belonging to indices 0 and 1. Now recall the definition of B-splines of degree l

$$B_l(t) = \bigotimes_{k=0}^l B_0(t),$$

from which we immediately get the associated generating function

$$S(z) = \frac{1}{2^l} (1 + z)^{l+1}.$$

The values s_k used for the definition of the subdivision matrix are simply the coefficients of the various powers of z in the polynomial $S(z)$

$$S(z) = \frac{1}{2^l} \sum_{k=0}^{l+1} \binom{l+1}{k} z^k,$$

where we used the binomial theorem to expand $S(z)$. Note how this matches the definition of s_k in Equation 2.1.

Recall Theorem 1, which we used to argue that B-splines of degree n are C^{n-1} continuous. That same theorem can now be expressed in terms of generating functions as follows

Theorem 2 *If $S(z)$ defines a convergent subdivision scheme yielding a C^k -continuous limit function then $\frac{1}{2}(1 + z)S(z)$ defines a convergent subdivision scheme with C^{k+1} -continuous limit functions.*

We will put this theorem to work in analyzing a given subdivision scheme by peeling off as many factors of $\frac{1}{2}(1 + z)$ as possible, while still being able to prove that the remainder converges to a continuous limit function. With this trick in hand all we have left to do is establish criteria for the convergence of a subdivision scheme to a continuous function. Once we can verify such a condition for the subdivision scheme associated with B-spline control points we will be justified in drawing the piecewise linear approximations of control polygons as approximations for the spline curve itself. We now turn to this task.

2.3.2 Convergence of Subdivision

There are many ways to talk about the convergence of a sequence of functions to a limit. One can use different norms and different notions of convergence. For our purposes the simplest form will suffice, uniform convergence.

We say that a sequence of functions f_i defined on some interval $[a, b] \subset \mathbf{R}$ converges *uniformly* to a limit function f if for all $\varepsilon > 0$ there exists an $n_0 > 0$ such that for all $n > n_0$

$$\max_{t \in [a, b]} |f(t) - f_n(t)| < \varepsilon.$$

Or in words, as of a certain index (n_0) all functions in the sequence “live” within an ε sized tube around the limit function f . This form of convergence is sufficient for our purposes and it has the nice property that if a sequence of continuous functions converges uniformly to some limit function f , that limit function is itself continuous.

For later use we introduce some norm symbols

$$\begin{aligned} \|f(t)\| &= \sup_t |f(t)| \\ \|\mathbf{p}\| &= \sup_i |p_i| \\ \|S\| &= \sup_i \sum_k |S_{ik}|, \end{aligned}$$

which are compatible in the sense that, for example, $\|S\mathbf{p}\| \leq \|S\| \|\mathbf{p}\|$.

The sequence of functions we want to analyze now are the control polygons as we refine them with the subdivision rule S . Recall that the control polygon is the piecewise linear curve through the control points \mathbf{p}^j at level j . Independent of the subdivision rule S we can use the linear B-splines to define the piecewise linear curve through the control points as $P^j(t) = \mathbf{B}_1(2^j t) \mathbf{p}^j$.

One way to show that a given subdivision scheme S converges to a continuous limit function is to prove that (1) the limit

$$P^\infty(t) = \lim_{j \rightarrow \infty} P^j(t)$$

exists for all t and (2) that the sequence $P^j(t)$ converges uniformly. In order to show this property we need to make the assumption that all rows of the matrix S sum to 1, i.e., the odd and even coefficients of the refinement relation separately sum to 1. This is a reasonable requirement since it is needed to ensure the affine invariance of the subdivision process, as we will later see. In matrix notation this means $S\mathbf{1} = \mathbf{1}$, or in other words, the vector of all 1's is an eigenvector of the subdivision matrix with eigenvalue 1. In

terms of generating functions this means $S(-1) = 0$, which is easily verified for the generating functions we have seen so far.

Recall that the definition of continuity in the function setting is based on differences. We say $f(t)$ is continuous at t_0 if for any $\varepsilon > 0$ there exists a $\delta > 0$ so that $|f(t_0) - f(t)| < \varepsilon$ as long as $|t_0 - t| < \delta$. The corresponding tool in the subdivision setting is the difference between two adjacent control points $p_{i+1}^j - p_i^j = (\Delta \mathbf{p}^j)_i$. We will show that if the differences between neighboring control points shrink fast enough, the limit curve will exist and be continuous:

Lemma 3 *If $\|\Delta \mathbf{p}^j\| < c\gamma^j$ for some constant $c > 0$ and a shrinkage factor $0 < \gamma < 1$ for all $j > j_0 \geq 0$ then $P^j(t)$ converges to a continuous limit function $P^\infty(t)$.*

Proof: Let S be the subdivision rule at hand, $\mathbf{p}^1 = S\mathbf{p}^0$ and S_1 be the subdivision rule for B-splines of degree 1. Notice that the rows of $S - S_1$ sum to 0

$$(S - S_1)\mathbf{1} = S\mathbf{1} - S_1\mathbf{1} = \mathbf{1} - \mathbf{1} = \mathbf{0}.$$

This implies that there exists a matrix D such that $S - S_1 = D\Delta$, where Δ computes the difference of adjacent elements $(\Delta)_{ii} = -1$, $(\Delta)_{i,i+1} = 1$, and zero otherwise. The entries of D are given as $D_{ij} = -\sum_{k=i}^j (S - S_1)_{ik}$. Now consider the difference between two successive piecewise linear approximations of the control points

$$\begin{aligned} \|P^{j+1}(t) - P^j(t)\| &= \|\mathbf{B}_1(2^{j+1}t)\mathbf{p}^{j+1} - \mathbf{B}_1(2^j t)\mathbf{p}^j\| \\ &= \|\mathbf{B}_1(2^{j+1}t)S\mathbf{p}^j - \mathbf{B}_1(2^{j+1}t)S_1\mathbf{p}^j\| \\ &= \|\mathbf{B}_1(2^{j+1}t)(S - S_1)\mathbf{p}^j\| \\ &\leq \|\mathbf{B}_1(2^{j+1}t)\| \|D\Delta \mathbf{p}^j\| \\ &\leq \|D\| \|\Delta \mathbf{p}^j\| \\ &\leq \|D\| c\gamma^j. \end{aligned}$$

This implies that the telescoping sum $P^0(t) + \sum_{k=0}^j (P^{k+1} - P^k)(t)$ converges to a well defined limit function since the norms of each summand are bounded by a constant times a geometric term γ^j . Let $P^\infty(t)$ as $j \rightarrow \infty$, then

$$\|P^\infty(t) - P^j(t)\| < \frac{\|D\|c}{1-\gamma}\gamma^j,$$

since the latter is the tail of a geometric series. This implies uniform convergence and thus continuity of $P^\infty(t)$ as claimed.

How do we check such a condition for a given subdivision scheme? Suppose we had a derived subdivision scheme D for the differences themselves

$$\Delta \mathbf{p}^{j+1} = D \Delta \mathbf{p}^j,$$

defined as the scheme that satisfies

$$\Delta S = D \Delta.$$

Or in words, we are looking for a *difference scheme* D such that taking differences after subdivision is the same as applying the difference scheme to the differences. Does D always exist? The answer is yes if S is affinely invariant, i.e., $S(-1) = 0$. This follows from the following argument. Multiplying S by Δ computes a matrix whose rows are differences of adjacent rows in S . Since odd and even numbered rows of S each sum to one, the rows of ΔS must each sum to zero. Now the existence of a matrix D such that $\Delta S = D \Delta$ follows as in the argument above.

Given this difference scheme D all we would have to show is that some power $m > 0$ of D has norm less than 1, $\|D^m\| = \gamma < 1$. In that case $\|\Delta \mathbf{p}^j\| < c(\gamma^{1/m})^j$. (We will see in a moment that the extra degree of freedom provided by the parameter m is needed in some cases.)

As an example, let us check this condition for cubic B-splines. Recall that $B_3(z) = \frac{1}{8}(1+z)^4$, i.e.,

$$\begin{aligned} p_{2i+1}^{j+1} &= \frac{1}{8}(4p_i^j + 4p_{i+1}^j) \\ p_{2i}^{j+1} &= \frac{1}{8}(p_{i-1}^j + 6p_i^j + p_{i+1}^j). \end{aligned}$$

Taking differences we have

$$\begin{aligned} (\Delta \mathbf{p}^{j+1})_{2i} &= p_{2i+1}^{j+1} - p_{2i}^{j+1} = \frac{1}{8}(-p_{i-1}^j - 2p_i^j + 3p_{i+1}^j) \\ &= \frac{1}{8}(3(p_{i+1}^j - p_i^j) + 1(p_i^j - p_{i-1}^j)) = \frac{1}{8}(3(\Delta \mathbf{p}^j)_i + 1(\Delta \mathbf{p}^j)_{i-1}), \end{aligned}$$

and similarly for the odd entries so that $D(z) = \frac{1}{8}(1+z)^3$, from which we conclude that $\|D\| = \frac{1}{2}$, and that the subdivision scheme for cubic B-splines converges uniformly to a continuous limit function, namely the B-spline itself.

Another example, which is not a spline, is the so called 4 point scheme [6]. It was used to create the curve in Figure 2.1, which is interpolating rather than approximating as is the case with splines. The generating function for the 4 point scheme is

$$S(z) = \frac{1}{16}(-z^{-3} + 4z^{-2} - z^{-1})(1+z)^4$$

Recall that each additional factor of $\frac{1}{2}(1+z)$ in the generating function increases the order of continuity of the subdivision scheme. If we want to show that the limit function of the 4 point scheme is differentiable we need to show that $\frac{1}{8}(-z^{-3} + 4z^{-2} - z^{-1})(1+z)^3$ converges to a continuous limit function. This in turn requires that $D(z) = \frac{1}{8}(-z^{-3} + 4z^{-2} - z^{-1})(1+z)^2$ satisfy a norm estimate as before. The rows of D have non-zero entries of $(\frac{1}{4}, \frac{1}{4})$, and $(\frac{-1}{8}, \frac{6}{8}, \frac{-1}{8})$ respectively. Thus $\|D\| = 1$, which is not strong enough. However, with a little bit more work one can show that $\|D^2\| = \frac{3}{4}$, so that indeed the 4 point scheme is C^1 .

In general, the difficult part is to find a set of coefficients for which subdivision converges. There is no general method to achieve this. Once a convergent subdivision scheme is found, one can always obtain a desired order of continuity by convolving with the box function.

2.3.3 Summary

So far we have considered subdivision only in the context of splines where the subdivision rule, i.e., the coefficients used to compute a refined set of control points, was fixed and everywhere the same. There is no pressing reason for this to be so. We can create a variety of different curves by manipulating the coefficients of the subdivision matrix. This could be done globally or locally. I.e., we could change the coefficients within a subdivision level and/or between subdivision levels. In this regard, splines are just a special case of the more general class of curves, subdivision curves. For example, at the beginning of this chapter we briefly outlined an interpolating subdivision method, while spline based subdivision is approximating rather than interpolating.

Why would one want to draw a spline curve by means of subdivision? In fact there is no sufficiently strong reason for using subdivision in one dimension and none of the commercial line drawing packages do so, but the argument becomes much more compelling in higher dimensions as we will see in later chapters.

In the next section we use the subdivision matrix to study the behavior of the resulting curve at a point or in the neighborhood of a point. We will see that it is quite easy, for example, to evaluate the curve exactly at a point, or to compute a tangent vector, simply from a deeper understanding of the subdivision matrix.

2.4 Analysis of Subdivision

In the previous section we have shown that uniform spline curves can be thought of as a special case of subdivision curves. So far, we have seen only examples for which we use a fixed set of coefficients to

compute the control points everywhere. The coefficients define the appearance of the curve, for example, whether it is differentiable or has sharp corners. Consequently it is possible to control the appearance of the curve by modifying the subdivision coefficients locally. So far we have not seen a compelling reason to do so in the 1D setting. However, in the surface setting it will be essential to change the subdivision rule locally around extraordinary vertices to ensure maximal order of continuity. But before studying this question we once again look at the curve setting first since the treatment is considerably easier to follow in that setting.

To study properties such as differentiability of the curve (or surface) we need to understand which of the control points influences the neighborhood of the point of interest. This notion is captured by the concept of invariant neighborhoods to which we turn now.

2.4.1 Invariant Neighborhoods

Suppose we want to study the limit curve of a given subdivision scheme in the vicinity of a particular control point.³ To determine *local* properties of a subdivision curve, we do not need the whole infinite vector of control points or the infinite matrix describing subdivision of the entire curve. Differentiability, for example, is a local property of a curve. To study it we need consider only an arbitrarily small piece of the curve around the origin. This leads to the question of which control points influence the curve in the neighborhood of the origin?

As a first example consider cubic B-spline subdivision. There is one cubic segment to the left of the origin with parameter values $t \in [-1, 0]$ and one segment to the right with parameter range $t \in [0, 1]$. Figure 2.6 illustrates that we need 5 control points at the coarsest level to reach any point of the limit curve which is associated with a parameter value between -1 and 1 , no matter how close it is to the origin. We say that the *invariant neighborhood* has size 5. This size depends on the number of non-zero entries in each row of the subdivision matrix, which is 2 for odd points and 3 for even points. The latter implies that we need one extra control point to the left of -1 and one to the right of 1 .

Another way to see this argument is to consider the basis functions associated with a given subdivision scheme. Once those are found we can find all basis functions overlapping a region of interest and their control points will give us the control set for that region. How do we find these basis functions in the setting when we don't necessarily produce B-splines through subdivision? The argument is straightforward

³Here and in the following we assume that the point of interest is the origin. This can always be achieved through renumbering of the control points.

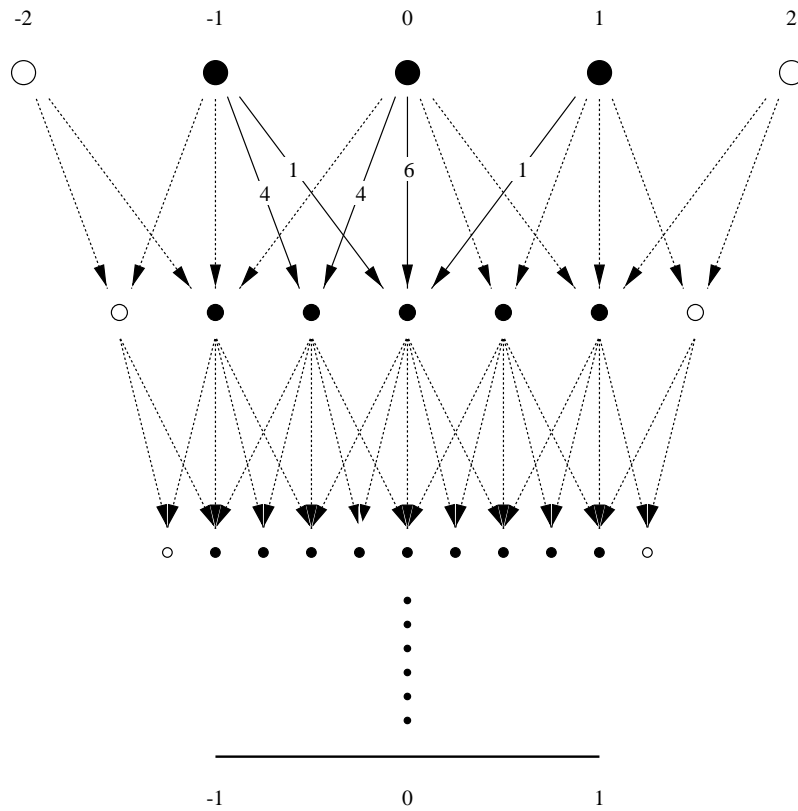

Figure 2.6: In the case of cubic B-spline subdivision the invariant neighborhood is of size 5. It takes 5 control points at the coarsest level to determine the behavior of the subdivision limit curve over the two segments adjacent to the origin. At each level we need one more control point on the outside of the interval $t \in [-1, 1]$ in order to continue on to the next subdivision level. 3 initial control points for example would not be enough.

and also applies to surfaces. Recall that the subdivision operator is linear, i.e.,

$$\begin{aligned}
 P^j(t) &= \mathbf{B}_1(2^j t) S^j \mathbf{p}^0 \\
 &= \mathbf{B}_1(2^j t) S^j \left(\sum_i p_i^0 (\mathbf{e}_i)^0 \right) \\
 &= \sum_i p_i^0 \mathbf{B}_1(2^j t) S^j (\mathbf{e}_i)^0 \\
 &= \sum_i p_i^0 \Phi_i^j(t)
 \end{aligned}$$

In this expression \mathbf{e}_i^0 stands for the vector consisting of all 0s except a single 1 in position i . In other

words the final curve is always a linear combination with weights p_i^0 of *fundamental solutions*

$$\lim_{j \rightarrow \infty} \varphi_i^j(t) = \varphi_i(t).$$

If we used the same subdivision weights throughout the domain it is easy to see that $\varphi_i(t) = \varphi(t - i)$, i.e., there is a single function $\varphi(t)$ such that all curves produced through subdivision from some initial sequence of points \mathbf{p}^0 are linear combinations of translates of $\varphi(t)$. This function is called the fundamental solution of the subdivision scheme. Questions such as differentiability of the limit curve can now be studied by examining this one function

$$\varphi(t) = \lim_{j \rightarrow \infty} S^j(\mathbf{e}_0)^0.$$

For example, we can read off from the support of this function how far the influence of a control point will be felt. Similarly, the shape of this function tells us something about how the curve (or surface) will change when we pull on a control point. Note that in the surface case the rules we apply will depend on the valence of the vertex in question. In that case we won't get only a single fundamental solution, but a different one for each valence. More on this later.

With this we can revisit the argument for the size of the invariant neighborhood. The basis functions of cubic B-spline subdivision have support width of 4 intervals. If we are interested in a small open neighborhood of the origin we notice that 5 basis functions will overlap that small neighborhood. The fact that the central 5 control points control the behavior of the limit curve at the origin holds independent of the level. With the central 5 control points at level j we can compute the central 5 control points at level $j + 1$. This implies that in order to study the behavior of the curve at the origin all we have to analyze is a small 5×5 subblock of the subdivision matrix

$$\begin{pmatrix} p_{-2}^{j+1} \\ p_{-1}^{j+1} \\ p_0^{j+1} \\ p_1^{j+1} \\ p_2^{j+1} \end{pmatrix} = \frac{1}{8} \begin{pmatrix} 1 & 6 & 1 & 0 & 0 \\ 0 & 4 & 4 & 0 & 0 \\ 0 & 1 & 6 & 1 & 0 \\ 0 & 0 & 4 & 4 & 0 \\ 0 & 0 & 1 & 6 & 1 \end{pmatrix} \begin{pmatrix} p_{-2}^j \\ p_{-1}^j \\ p_0^j \\ p_1^j \\ p_2^j \end{pmatrix}.$$

The 4 point subdivision scheme provides another example. This time we do not have recourse to splines to argue the properties of the limit curve. In this case each basis function has a support ranging over 6 intervals. An easy way to see this is to start with the sequence \mathbf{e}_0^0 , i.e., a single 1 at the origin surrounded by zeros. Repeatedly applying subdivision we can see that no points outside the original $[-3, 3]$ interval will become non-zero. Consequently for the invariant neighborhood of the origin we

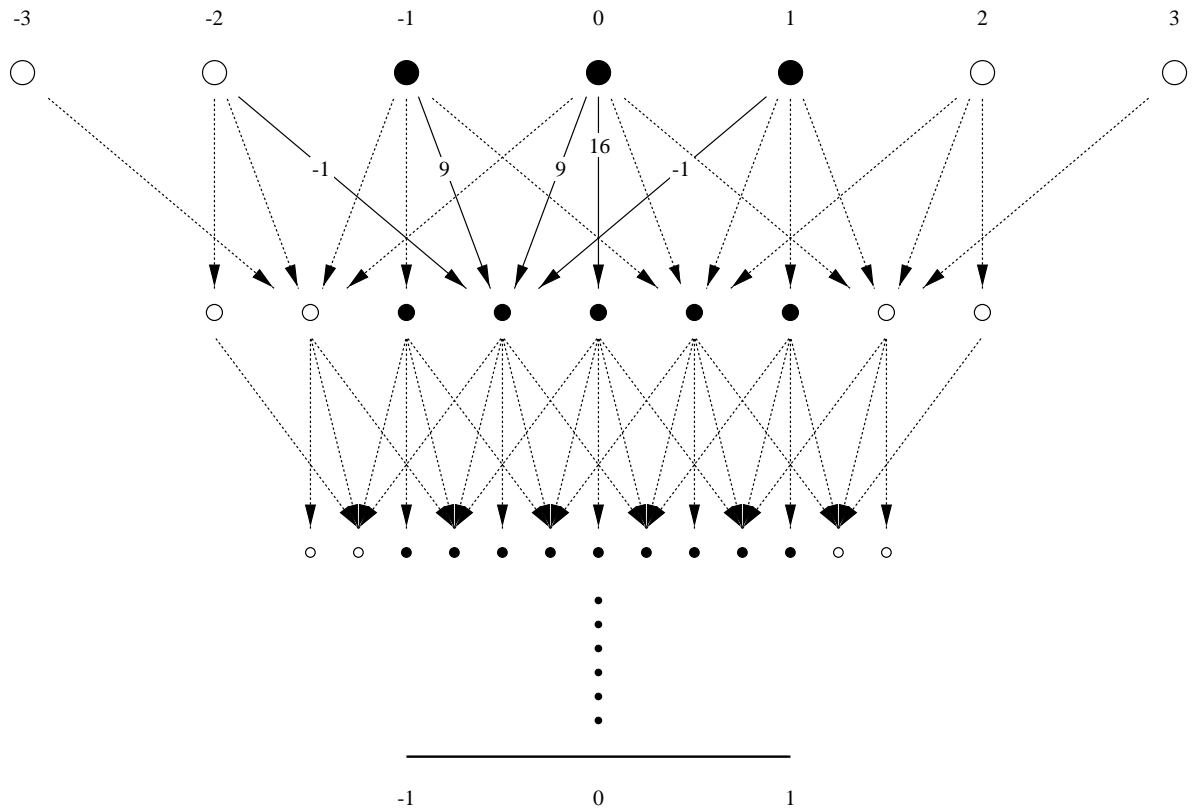

Figure 2.7: In the case of the 4 point subdivision rule the invariant neighborhood is of size 7. It takes 7 control points at the coarsest level to determine the behavior of the subdivision limit curve over the two segments adjacent to the origin. One extra point at p_2^j is needed to compute p_1^{j+1} . The other is needed to compute p_3^{j+1} , which requires p_3^j . Two extra points on the left and right result in a total of 7 in the invariant neighborhood.

need to consider 3 basis functions to the left, the center function, and 3 basis functions to the right. The 4 point scheme has an invariant neighborhood of 7 (see Figure 2.7). In this case the local subdivision

matrix is given by

$$\begin{pmatrix} p_{-3}^{j+1} \\ p_{-2}^{j+1} \\ p_{-1}^{j+1} \\ p_0^{j+1} \\ p_1^{j+1} \\ p_2^{j+1} \\ p_3^{j+1} \end{pmatrix} = \frac{1}{16} \begin{pmatrix} -1 & 9 & 9 & -1 & 0 & 0 & 0 \\ 0 & 0 & 16 & 0 & 0 & 0 & 0 \\ 0 & -1 & 9 & 9 & -1 & 0 & 0 \\ 0 & 0 & 0 & 16 & 0 & 0 & 0 \\ 0 & 0 & -1 & 9 & 9 & -1 & 0 \\ 0 & 0 & 0 & 0 & 16 & 0 & 0 \\ 0 & 0 & 0 & -1 & 9 & 9 & -1 \end{pmatrix} \begin{pmatrix} p_{-3}^{j+1} \\ p_{-2}^{j+1} \\ p_{-1}^{j+1} \\ p_0^{j+1} \\ p_1^{j+1} \\ p_2^{j+1} \\ p_3^{j+1} \end{pmatrix}$$

Since the local subdivision matrix controls the behavior of the curve in a neighborhood of the origin, it comes as no surprise that many properties of curves generated by subdivision can be inferred from the properties of the local subdivision matrix. In particular, differentiability properties of the curve are related to the eigen structure of the local subdivision matrix to which we now turn. From now on the symbol S will denote the *local* subdivision matrix.

2.4.2 Eigen Analysis

Recall from linear algebra that an *eigenvector* \mathbf{x} of the matrix M is a non-zero vector such that $M\mathbf{x} = \lambda\mathbf{x}$, where λ is a scalar. We say that λ is the *eigenvalue* corresponding to the right eigenvector \mathbf{x} .

Assume the local subdivision matrix S has size $n \times n$ and has real eigenvectors $\mathbf{x}_0, \mathbf{x}_1, \dots, \mathbf{x}_{n-1}$, which form a basis, with corresponding real eigenvalues $\lambda_0 \geq \lambda_1 \geq \dots \geq \lambda_{n-1}$. For example, in the case of cubic splines $n = 5$ and

$$\begin{aligned} (\lambda_0, \lambda_1, \lambda_2, \lambda_3, \lambda_4) &= \left(1, \frac{1}{2}, \frac{1}{4}, \frac{1}{8}, \frac{1}{8}\right) \\ (\mathbf{x}_0, \mathbf{x}_1, \mathbf{x}_2, \mathbf{x}_3, \mathbf{x}_4) &= \begin{pmatrix} 1 & -1 & 1 & 1 & 0 \\ 1 & -\frac{1}{2} & \frac{2}{11} & 0 & 0 \\ 1 & 0 & -\frac{1}{11} & 0 & 0 \\ 1 & \frac{1}{2} & \frac{2}{11} & 0 & 0 \\ 1 & 1 & 1 & 0 & 1 \end{pmatrix}. \end{aligned}$$

Given these eigenvectors we have

$$S(\mathbf{x}_0, \mathbf{x}_1, \mathbf{x}_2, \mathbf{x}_3, \mathbf{x}_4) = (\mathbf{x}_0, \mathbf{x}_1, \mathbf{x}_2, \mathbf{x}_3, \mathbf{x}_4) \begin{pmatrix} \lambda_0 & 0 & 0 & 0 & 0 \\ 0 & \lambda_1 & 0 & 0 & 0 \\ 0 & 0 & \lambda_2 & 0 & 0 \\ 0 & 0 & 0 & \lambda_3 & 0 \\ 0 & 0 & 0 & 0 & \lambda_4 \end{pmatrix}$$

$$SX = XD$$

$$X^{-1}SX = D.$$

The rows $\tilde{\mathbf{x}}_i$ of X^{-1} are called left eigenvectors since they satisfy $\tilde{\mathbf{x}}_i S = \lambda_i \tilde{\mathbf{x}}_i$, which can be seen by multiplying the last equality with X^{-1} on the right.

Note: not all subdivision schemes have only real eigenvalues or a complete set of eigenvectors. For example, the 4 point scheme has eigenvalues

$$(\lambda_0, \lambda_1, \lambda_2, \lambda_3, \lambda_4, \lambda_5, \lambda_6) = \left(1, \frac{1}{2}, \frac{1}{4}, \frac{1}{4}, \frac{1}{8}, -\frac{1}{16}, -\frac{1}{16}\right),$$

but it does not have a complete set of eigenvectors. These degeneracies are the cause of much technical difficulty in the theory of subdivision. To keep our exposition simple and communicate the essential ideas we will ignore these cases and assume from now on that we have a complete set of eigenvectors.

In this setting we can write any vector \mathbf{p} of length n as a linear combination of eigenvectors:

$$\mathbf{p} = \sum_{i=0}^{n-1} a_i \mathbf{x}_i,$$

where the a_i are given by the inner products $a_i = \tilde{\mathbf{x}}_i \cdot \mathbf{p}$. This decomposition works also when the entries of \mathbf{p} are n 2-D points (or 3-D points in the case of surfaces) rather than single numbers. In this case each ‘‘coefficient’’ a_i is a 2-D (3-D) point. The eigenvectors $\mathbf{x}_0, \dots, \mathbf{x}_{n-1}$ are simply vectors of n real numbers.

In the basis of eigenvectors we can easily compute the result of application of the subdivision matrix to a vector of control points, that is, the control points on the next level

$$\begin{aligned} S\mathbf{p}^0 &= S \sum_{i=0}^{n-1} a_i \mathbf{x}_i \\ &= \sum_{i=0}^{n-1} a_i S\mathbf{x}_i \quad \text{by linearity of } S \\ &= \sum_{i=0}^{n-1} a_i \lambda_i \mathbf{x}_i \end{aligned}$$

Applying S j times, we obtain

$$\mathbf{p}^j = S^j \mathbf{p}^0 = \sum_{i=0}^{n-1} a_i \lambda_i^j \mathbf{x}_i.$$

2.4.3 Convergence of Subdivision

If $\lambda_0 > 1$, then $S^j \mathbf{x}^0$ would grow without bound as j increased and subdivision would not be convergent. Hence, we can see that in order for the sequence $S^j \mathbf{p}^0$ to converge at all, it is necessary that all eigenvalues are at most 1. It is also possible to show that only a single eigenvalue may have magnitude 1 [33].

A simple consequence of this analysis is that we can compute the limit position directly in the eigen basis

$$P^\infty(0) = \lim_{j \rightarrow \infty} S^j \mathbf{p}^0 = \lim_{j \rightarrow \infty} \sum_{i=0}^{n-1} a_i \lambda_i^j \mathbf{x}_i = a_0,$$

since all eigen components $|\lambda_i| < 1$ decay to zero. For example, in the case of cubic B-spline subdivision we can compute the limit position of p_i^j as $a_0 = \tilde{\mathbf{x}}_0 \cdot \mathbf{p}^j$, which amounts to

$$p_i^\infty = a_0 = \frac{1}{6}(p_{i-1}^j + 4p_i^j + p_{i+1}^j).$$

Note that this expression is completely independent of the level j at which it is computed.

2.4.4 Invariance under Affine Transformations

If we moved all the control points simultaneously by the same amount, we would expect the curve defined by these control points to move in the same way as a rigid object. In other words, the curve should be *invariant under distance-preserving transformations, such as translation and rotation*. It follows from linearity of subdivision that if subdivision is invariant with respect to distance-preserving transformations, it also should be invariant under any affine transformations. The family of affine transformations in addition to distance-preserving transformations, contains shears.

Let $\mathbf{1}$ be an n -vector of 1's and $a \in \mathbf{R}^2$ a displacement in the plane (see Figure 2.8) Then $\mathbf{1} \cdot a$ represents a displacement of our seven points by a vector a . Applying subdivision to the transformed points, we get

$$\begin{aligned} S(\mathbf{p}^j + \mathbf{1} \cdot a) &= S\mathbf{p}^j + S(\mathbf{1} \cdot a) \quad \text{by linearity of } S \\ &= \mathbf{p}^{j+1} + S(\mathbf{1} \cdot a). \end{aligned}$$

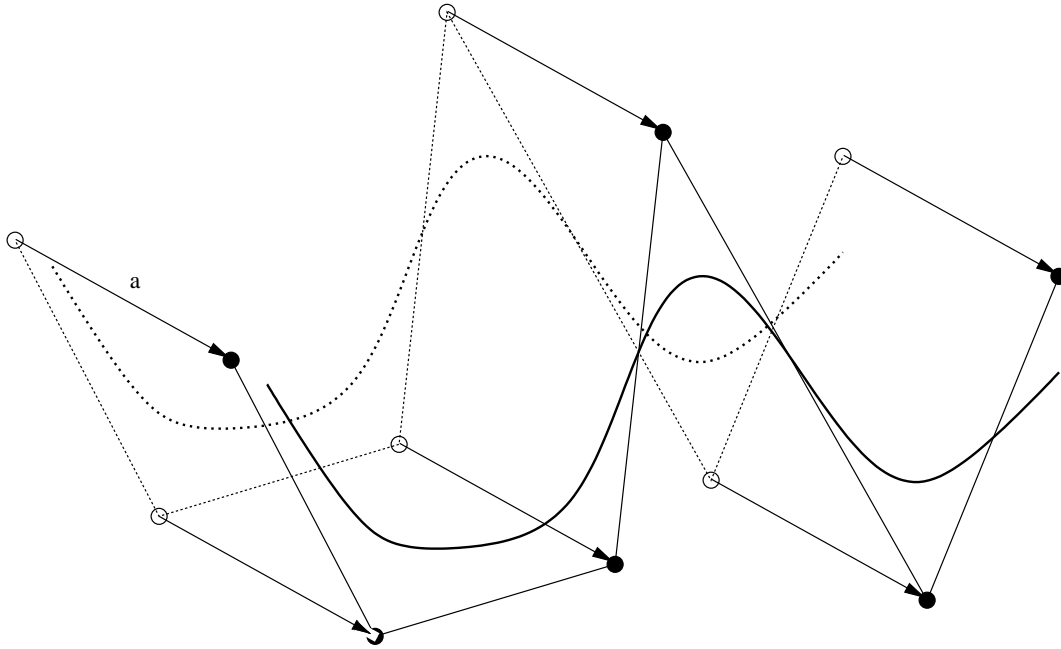

Figure 2.8: *Invariance under translation.*

From this we see that for translational invariance we need

$$S(\mathbf{1} \cdot a) = \mathbf{1} \cdot a$$

Therefore, $\mathbf{1}$ should be the eigenvector of S with eigenvalue $\lambda_0 = 1$.

Recall that when proving convergence of subdivision we assumed that $\mathbf{1}$ is an eigenvector with eigenvalue 1. We now see that this assumption is satisfied by any reasonable subdivision scheme. It would be rather unnatural if the shape of the curve changed as we translate control points.

2.4.5 Geometric Behavior of Repeated Subdivision

If we assume that λ_0 is 1, and all other eigenvalues are less than 1, we can choose our coordinate system in such a way that a_0 is the origin in \mathbf{R}^2 . In that case we have

$$\mathbf{p}^j = \sum_{i=1}^{n-1} a_i \lambda_i^j \mathbf{x}_i$$

Dividing both sides by λ_1^j , we obtain

$$\frac{1}{\lambda_1^j} \mathbf{p}^j = a_1 \mathbf{x}_1 + \sum_{i=2}^{n-1} a_i \left(\frac{\lambda_i}{\lambda_1} \right)^j \mathbf{x}_i.$$

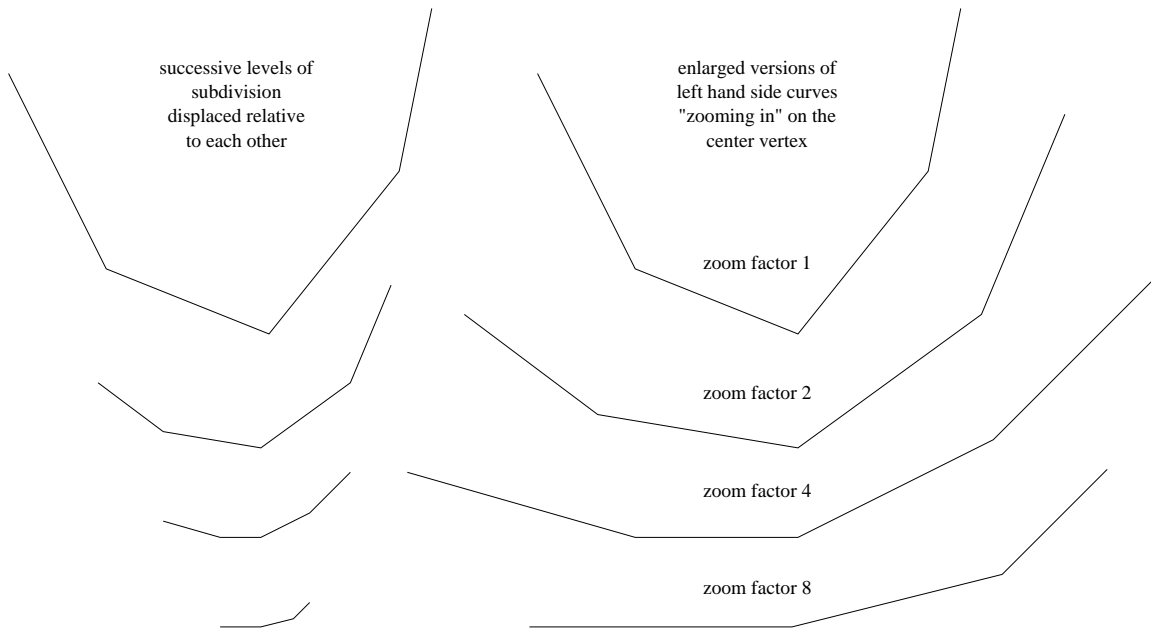

Figure 2.9: Repeatedly applying the subdivision matrix to our set of n control points results in the control points converging to a configuration aligned with the tangent vector. The various subdivision levels have been offset vertically for clarity.

If we assume that $|\lambda_2|, \dots, |\lambda_{n-1}| < |\lambda_1|$, the sum on the right approaches zero as $j \rightarrow \infty$. In other words the term corresponding to λ_1 will “dominate” the behavior of the vector of control points. In the limit, we get a set of n points arranged along the vector a_1 . Geometrically, this is a vector tangent to our curve at the center point (see Figure 2.9).

Just as in the case of computing the limit point of cubic B-spline subdivision by computing a_0 we can compute the tangent vector at p_i^j by computing $a_1 = \tilde{\mathbf{x}}_1 \cdot \mathbf{p}^j$

$$t_i^\infty = a_1 = p_{i+1}^j - p_{i-1}^j.$$

If there were two equal eigenvalues, say $\lambda_1 = \lambda_2$, as j increases, the points in the limit configuration will be linear combinations of two vectors a_1 and a_2 , and in general would not be on the same line. This indicates that there will be no tangent vector at the central point. This leads us to the following condition, that, under some additional assumptions, is necessary for the existence of a tangent

All eigenvalues of S except $\lambda_0 = 1$ should be less than λ_1 .

2.4.6 Size of the Invariant Neighborhood

We have argued above that the size of the invariant neighborhood for cubic splines is 5 (7 for the 4pt scheme). This was motivated by the question of which basis functions overlap a finite sized, however small, neighborhood of the origin. Yet, when we computed the limit position as well as the tangent vector for the cubic spline subdivision we used left eigenvectors, whose non-zero entries did not extend beyond the immediate neighbors of the vertex at the origin. This turns out to be a general observation. While the larger invariant neighborhood is needed for *analysis*, we can actually get away with a smaller neighborhood if we are only interested in *computation* of point positions and tangents at those points corresponding to one of the original vertices. The value of the subdivision curve at the center point only depends on those basis functions which are non-zero at that point. In the case of cubic spline subdivision there are only 3 basis functions with this property. Similarly the first derivatives at the origin of the basis functions centered at -2 and +2 are zero as well. Hence the derivative only depends on the immediate neighbors as well. This must be so since the subdivision scheme is C^1 . The basis functions have zero derivative at the edge of their support by C^1 -continuity assumption, because outside of the support the derivative is identically zero.

For curves this distinction does not make too much of a difference in terms of computations, but in the case of surfaces life will be much easier if we can use a smaller invariant neighborhood for the computation of limit positions and tangents. For example, for Loop's scheme we will be able to use a 1-ring (only immediate neighbors) rather than a 2-ring. For the Butterfly scheme we will find that a 2-ring, rather than a 3-ring is sufficient to compute tangents.

2.4.7 Summary

For our subdivision matrix S we desire the following characteristics

- the eigenvectors should form a basis;
- the first eigenvalue λ_0 should be 1;
- the second eigenvalue λ_1 should be less than 1;
- all other eigenvalues should be less than λ_1 .

Chapter 3

Subdivision Surfaces

Denis Zorin, New York University

In this chapter we review the basic principles of subdivision surfaces. These principles can be applied to a variety of subdivision schemes described in Chapter 4: Doo-Sabin, Catmull-Clark, Loop, Modified Butterfly, Kobbelt, Midedge.

Some of these schemes were around for a while: the 1978 papers of Doo and Sabin and Catmull and Clark were the first papers describing subdivision algorithms for surfaces. Other schemes are relatively new. Remarkably, during the period from 1978 until 1995 little progress was made in the area. In fact, until Reif's work [26] on C^1 -continuity of subdivision most basic questions about the behavior of subdivision surfaces near extraordinary vertices were not answered. Since then there was a steady stream of new theoretical and practical results: classical subdivision schemes were analyzed [28, 18], new schemes were proposed [39, 11, 9, 19], and general theory was developed for C^1 and C^k -continuity of subdivision [26, 20, 35, 37]. Smoothness analysis was performed in some form for almost all known schemes, for all of them, definitive results were obtained during the last 2 years only.

One of the goals of this chapter is to provide an accessible introduction to the mathematics of subdivision surfaces (Sections 3.4 and 3.5). Building on the material of the first chapter, we concentrate on the few general concepts that we believe to be of primary importance: subdivision surfaces as parametric surfaces, C^1 -continuity, eigen structure of subdivision matrices, characteristic maps.

The developments of recent years have convinced us of the importance of understanding the mathematical foundations of subdivision. A Computer Graphics professional who wishes to use subdivision, probably is not interested in the subtle points of a theoretical argument. However, understanding the

general concepts that are used to construct and analyze subdivision schemes allows one to choose the most appropriate subdivision algorithm or customize one for a specific application.

3.1 Subdivision Surfaces: an Example

One of the simplest subdivision schemes is the *Loop scheme*, invented by Charles Loop [16]. We will use this scheme as an example to introduce some basic features of subdivision for surfaces.

The Loop scheme is defined for triangular meshes. The general pattern of refinement, which we call *vertex insertion*, is shown in Figure 3.1.

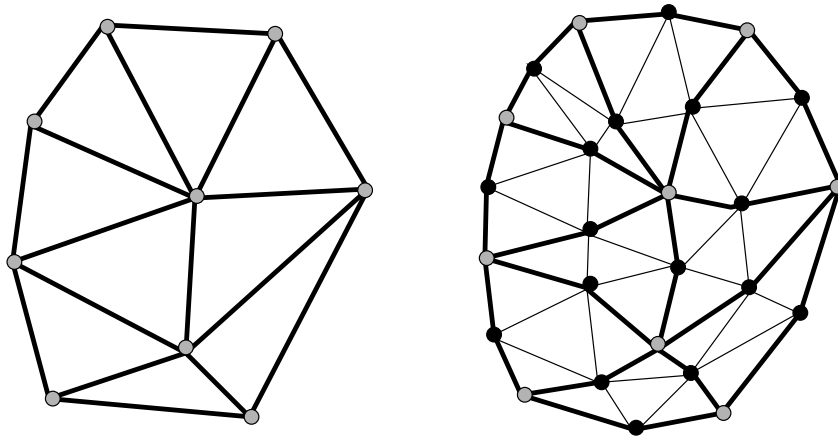

Figure 3.1: *Refinement of a triangular mesh. New vertices are shown as black dots. Each edge of the control mesh is split into two, and new vertices are reconnected to form 4 new triangles, replacing each triangle of the mesh.*

Like most (but not all) other subdivision schemes, this scheme is based on a spline basis function, called the three-directional quartic box spline. Unlike more conventional splines, such as the bicubic spline, the three-directional box spline is defined on the regular *triangular* grid; the generating polynomial for this spline is

$$S(z_1, z_2) = \frac{1}{16} (1 + z_1)^2 (1 + z_2)^2 (1 + z_1 z_2)^2.$$

Note that the generating polynomial for surfaces has two variables, while the generating polynomials for curves described in Chapter 2, had only one. This spline basis function is C^2 -continuous. Subdivision rules for it are shown in Figure 3.2.

In one dimension, once a spline basis is chosen, all the coefficients of the subdivision rules that are

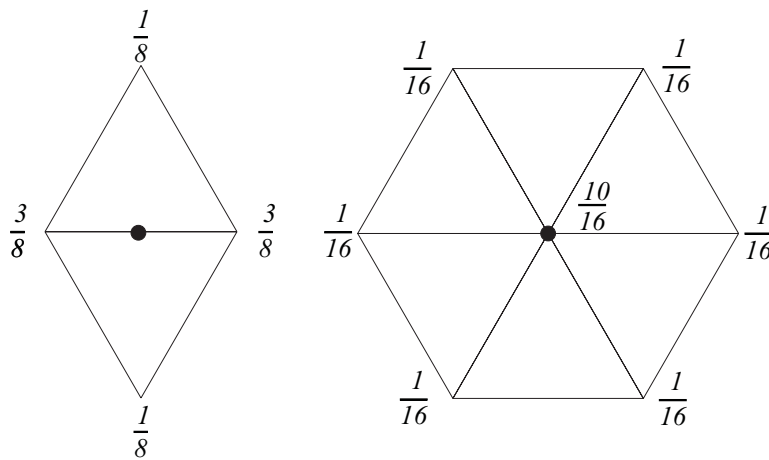

Figure 3.2: *Subdivision coefficients for a three directional box spline.*

needed to generate a curve are completely determined. The situation is radically different and more complex for surfaces. The structure of the control polygon for curves is always very simple: the vertices are arranged into a chain, and any two pieces of the chain of the same length always have identical structure. For two-dimensional meshes, the local structure of the mesh may vary: the number of edges connected to a vertex may be different from vertex to vertex. As a result the rules derived from the spline basis function may be applied only to parts of the mesh that are locally regular; that is, only to those vertices that have a valence of 6 (in the case of triangular schemes). In other cases, we have to design new rules for vertices with different valences. Such vertices are called *extraordinary*.

For the time being, we consider only meshes without a boundary. Note that the quartic box spline rule used to compute the control point inserted at an edge (Figure 3.2, left) can be applied anywhere. The only rule that needs modification is the rule used to compute new positions of control points inherited from the previous level.

Loop proposed to use coefficients shown in Figure 3.3. It turns out that this choice of coefficients guarantees that the limit surface of the scheme is “smooth.”

Note that these new rules only influence local behavior of the surface near extraordinary vertices. All vertices inserted in the course of subdivision are always regular, i.e., have valence 6.

This example demonstrates the main challenge in the design of subdivision schemes for surfaces: one has to define additional rules for irregular parts of the mesh in such a way that the limit surfaces have desired properties, in particular, are smooth. In this chapter one of our main goals is to describe the conditions that guarantee that a subdivision scheme produces smooth surfaces. We start with defin-

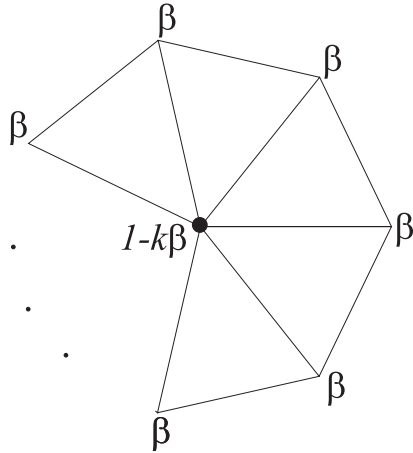

Figure 3.3: *Loop scheme: coefficients for extraordinary vertices. The choice of β is not unique; Loop [16] suggests $\frac{1}{k}(5/8 - (\frac{3}{8} + \frac{1}{4} \cos \frac{2\pi}{k})^2)$.*

ing subdivision surfaces more rigorously (Section 3.2), and defining subdivision matrices (Section 3.3). Subdivision matrices have many applications, including computing limit positions of the points on the surface, normals, and explicit evaluation of the surface (Chapter 4). Next, we define more precisely what a smooth surface is (Section 3.4), introducing two concepts of geometric smoothness—*tangent plane continuity* and C^1 -*continuity*. Then we explain how it is possible to understand local behavior of subdivision near extraordinary vertices using characteristic maps (Section 3.5). In Chapter 4 we discuss a variety of subdivision rules in a systematic way.

3.2 Natural Parameterization of Subdivision Surfaces

The subdivision process produces a sequence of polyhedra with increasing numbers of faces and vertices. Intuitively, the subdivision surface is the limit of this sequence. The problem is that we have to define what we mean by the limit more precisely. For this, and many other purposes, it is convenient to represent subdivision surfaces as functions defined on some parametric domain with values in \mathbf{R}^3 . In the regular case, the plane or a part of the plane is the domain. However, for arbitrary control meshes, it might be impossible to parameterize the surface continuously over a planar domain.

Fortunately, there is a simple construction that allows one to use the *initial control mesh*, or more precisely, the corresponding polygonal complex, as the domain for the surface.

Parameterization over the initial control mesh. We start with the simplest case: suppose the initial control mesh is a simple polyhedron, i.e., it does not have self-intersections.

Suppose each time we apply the subdivision rules to compute the finer control mesh, we also apply midpoint subdivision to a copy of the initial control polyhedron (see Figure 3.4). This means that we leave the old vertices where they are, and insert new vertices splitting each edge in two. Note that each control point that we insert in the mesh using subdivision corresponds to a point in the midpoint-subdivided polyhedron. Another important fact is that midpoint subdivision does not alter the control polyhedron regarded as a set of points; and no new vertices inserted by midpoint subdivision can possibly coincide.

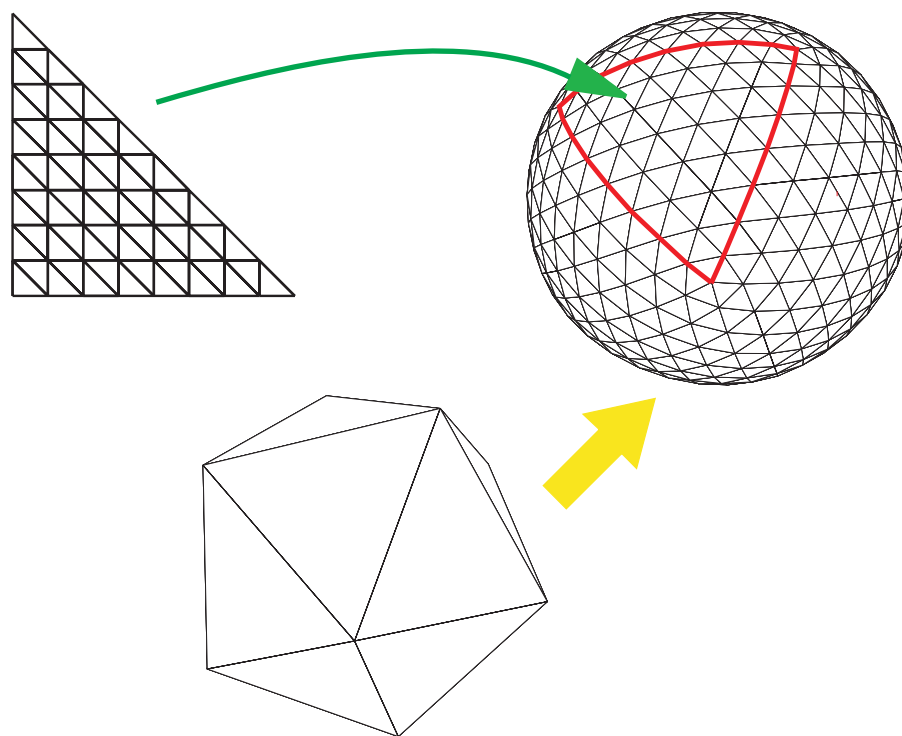

Figure 3.4: *Natural parameterization of the subdivision surface*

We will use the second copy of the control polyhedron as our domain. We denote it as K , when it is regarded as a polyhedron with identified vertices, edges and faces, and $|K|$ when it is regarded simply as a subset of \mathbf{R}^3 .

Important remark on notation: we will refer to the points computed by subdivision as **control points**; the word **vertex** is reserved for the vertices of the polyhedron that serves as the domain and new vertices added to it by midpoint subdivision. We will use the letter v to denote vertices, and $p^j(v)$ to denote the control point corresponding to v after j subdivision steps.

As we repeatedly subdivide, we get a mapping from a denser and denser subset of the domain to the control points of a finer and finer control mesh. At each step, we linearly interpolate between control vertices, and regard the mesh generated by subdivision as a piecewise linear function on the domain K . Now we have the same situation that we had for curves: a sequence of piecewise linear functions defined on a common domain. If this sequence of functions converges uniformly, the limit is a map f from $|K|$ into \mathbf{R}^3 . This is the limit surface of subdivision.

An important fact about the parameterization that we have just constructed is that for a regular mesh the domain can be taken to be the plane with a regular triangular grid. If in the regular case the subdivision scheme reduces to spline subdivision, our parameterization is precisely the standard (u, v) parameterization of the spline, which is guaranteed to be smooth.

To understand the general idea, this definition is sufficient, and a reader not interested in the subtle details can proceed to the next section and assume from now on that the initial mesh has no self-intersections.

General case. The crucial fact that we needed to parameterize the surface over its control polyhedron was the absence of self-intersections. Otherwise, it could happen that a vertex on the control polyhedron has more than one control point associated with it.

In general, we cannot rely on this assumption: quite often control meshes have self-intersections or coinciding control points. We can observe though that the positions of vertices of the control polyhedron are of no importance for our purposes: we can deform it in any way we want. In many cases, this is sufficient to eliminate the problem with self intersections; however, there are cases when the self-intersection cannot be removed by any deformation (example: Klein bottle, Figure 3.5). It is always possible to do that if we place our mesh in a higher-dimensional space; in fact, 4 dimensions are always enough.

This leads us to the following general choice of the domain: a polyhedron with no self-intersections, possibly in four-dimensional space. The polyhedron has to have the same structure as the initial control mesh of the surface, that is, there is a one-to-one correspondence between vertices, edges and faces of the domain and the initial control mesh. Note that now we are completely free to choose the control points of the initial mesh any way we like.

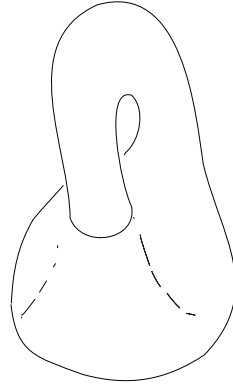

Figure 3.5: *The surface (Klein bottle) has an intersection that cannot be removed in 3D.*

3.3 Subdivision Matrix

An important tool both for understanding and using subdivision is the *subdivision matrix*, similar to the subdivision matrix for the curves introduced in Chapter 2. In this section we define the subdivision matrix and discuss how it can be used to compute tangent vectors and limit positions of points. Another application of subdivision matrices is explicit evaluation of subdivision surfaces described in Chapter 4.

Subdivision matrix. Similarly to the one-dimensional case, the subdivision matrix relates the control points in a fixed neighborhood of a vertex on two sequential subdivision levels. Unlike the one-dimensional case, there is not a single subdivision matrix for a given surface subdivision scheme: a separate matrix is defined for each valence.

For the Loop scheme control points for only two rings of vertices around an extraordinary vertex B define $f(U)$ completely. We will call the set of vertices in these two rings the *control set* of U .

Let p_0^j be the value at level j of the control point corresponding to B . Assign numbers to the vertices in the two rings (there are $3k$ vertices). Note that U^j and U^{j+1} are similar: one can establish a one-to-one correspondence between the vertices simply by shrinking U^j by a factor of 2. Enumerate the vertices in the rings; there are $3k$ vertices, plus the vertex in the center. Let $p_i^j, i = 1 \dots 3k$ be the corresponding control points.

By definition of the control set, we can compute all values p_i^{j+1} from the values p_i^j . Because we only consider subdivision which computes finer levels by linear combination of points from the coarser level,

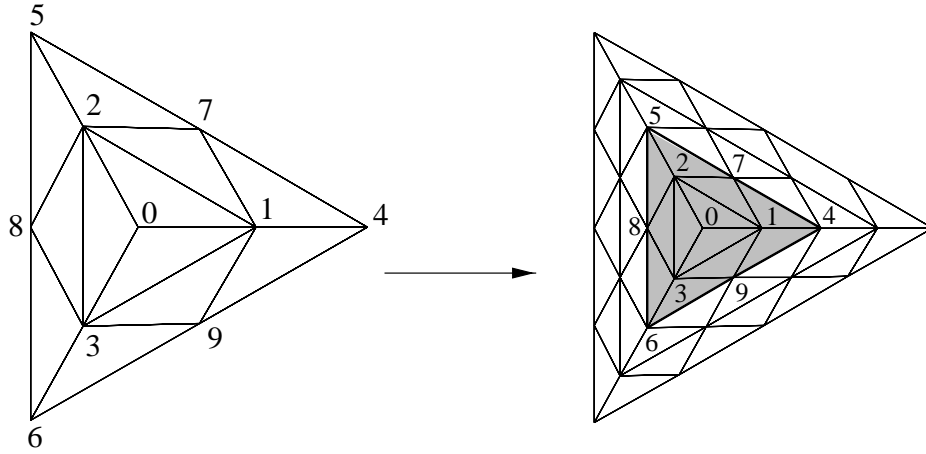

Figure 3.6: *The Loop subdivision scheme near a vertex of degree 3. Note that $3 \times 3 + 1 = 10$ points in two rings are required.*

the relation between the vectors of points \mathbf{p}^{j+1} and \mathbf{p}^j is given by a $(3k + 1) \times (3k + 1)$ matrix:

$$\begin{pmatrix} p_0^{j+1} \\ \vdots \\ p_{3k}^{j+1} \end{pmatrix} = S \begin{pmatrix} p_0^j \\ \vdots \\ p_{3k}^j \end{pmatrix}.$$

It is important to remember that each component of p^j is a point in the three-dimensional space. The matrix S is the subdivision matrix, which, in general, can change from level to level. We consider only schemes for which it is fixed. Such schemes are called *stationary*.

We can now rewrite each of the coordinate vectors in terms of the eigenvectors of the matrix S (compare to the use of eigen vectors in the 1D setting). Thus,

$$\mathbf{p}^0 = \sum_i \mathbf{a}_i x_i$$

and

$$\mathbf{p}^j = (S)^j \mathbf{p}^0 = \sum_i (\lambda_i)^j \mathbf{a}_i x_i$$

where the x_i are the eigenvectors of S , and the λ_i are the corresponding eigenvalues, arranged in non increasing order. As discussed for the one-dimensional case, λ_0 has to be 1 for all subdivision schemes, in order to guarantee invariance with respect to translations and rotations. Furthermore, all stable, converging subdivision schemes will have all the remaining λ_i less than 1.

Subdominant eigenvalues and eigenvectors It is clear that as we subdivide, the behavior of \mathbf{p}^j , which determines the behavior of the surface in the immediate vicinity of our point of interest, will depend only on the eigenvectors corresponding to the largest eigenvalues of S .

To proceed with the derivation, we will assume for simplicity that $\lambda = \lambda_1 = \lambda_2 > \lambda_3$. We will call λ_1 and λ_2 *subdominant eigenvalues*. Furthermore, we let $\mathbf{a}_0 = 0$; this corresponds to choosing the origin of our coordinate system in the limit position of the vertex of interest (just as we did in the 1D setting). Then we can write

$$\frac{\mathbf{p}^j}{(\lambda)^j} = \mathbf{a}_1 x_1 + \mathbf{a}_2 x_2 + \mathbf{a}_3 \left(\frac{\lambda_3}{\lambda}\right)^j x_3 \dots \quad (3.1)$$

where the higher-order terms disappear in the limit.

This formula is very important, and deserves careful consideration. Recall that \mathbf{p}^j is a vector of $3k+1$ 3D points, while x_i are vectors of $3k+1$ numbers. Hence the coefficients \mathbf{a}_i in the decomposition above have to be 3D points.

This means that, up to a scaling by $(\lambda)^j$, the control set for $f(U)$ approaches a fixed configuration. This configuration is determined by x_1 and x_2 , which depend only on the subdivision scheme, and on \mathbf{a}_1 and \mathbf{a}_2 which depend on the initial control mesh.

Each vertex in \mathbf{p}^j for sufficiently large j is a linear combination of \mathbf{a}_1 and \mathbf{a}_2 , up to a vanishing term. This indicates that \mathbf{a}_1 and \mathbf{a}_2 span the tangent plane. Also note that if we apply an affine transform A , taking \mathbf{a}_1 and \mathbf{a}_2 to coordinate vectors e_1 and e_2 in the plane, then, up to a vanishing term, the scaled configuration will be independent of the initial control mesh. The transformed configuration consists of 2D points with coordinates $(x_{1,i}, x_{2,i})$, $i = 0 \dots 3k$, which depend on the subdivision matrix.

Informally, this indicates that up to a vanishing term, all subdivision surfaces generated by a scheme differ near an extraordinary point only by an affine transform. In fact, this is not quite true: it may happen that a particular configuration $(x_{1,i}, x_{2,i})$, $i = 0 \dots 3k$ does not generate a surface patch, but, say, a curve. In that case, the vanishing terms will have influence on the smoothness of the surface.

Tangents and limit positions. We have observed that similar to the one-dimensional case, the coefficients \mathbf{a}_0 , \mathbf{a}_1 and \mathbf{a}_2 in the decomposition 3.1 are the limit position of the control point for the central vertex v_0 , and two tangents respectively. To compute these coefficients, we need corresponding left eigenvectors:

$$\mathbf{a}_0 = (l_0, \mathbf{p}), \quad \mathbf{a}_1 = (l_1, \mathbf{p}), \quad \mathbf{a}_2 = (l_2, \mathbf{p})$$

Similarly to the one-dimensional case, the left eigenvectors can be computed using only a smaller submatrix of the full subdivision matrix. For example, for the Loop scheme we need to consider the $k + 1 \times k + 1$ matrix acting on the control points of 1-neighborhood of the central vertex, not on the points of the 2-neighborhood.

In the descriptions of subdivision schemes in the next section we describe these left eigenvectors whenever information is available.

3.4 Smoothness of Surfaces

Intuitively, we call a surface smooth, if, at a close distance, it becomes indistinguishable from a plane. Before discussing smoothness of subdivision surfaces in greater detail, we have to define more precisely what we mean by a surface, in a way that is convenient for analysis of subdivision.

The discussion in the section is somewhat informal; for a more rigorous treatment, see [26, 25, 35],

3.4.1 C^1 -continuity and Tangent Plane Continuity

Recall that we have defined the subdivision surface as a function $f : |K| \rightarrow \mathbf{R}^3$ on a polyhedron. Now we can formalize our intuitive notion of smoothness, namely local similarity to a piece of the plane. A surface is smooth at a point x of its domain $|K|$, if for a sufficiently small neighborhood U_x of that point the image $f(U_x)$ can be smoothly deformed into a planar disk. More precisely,

Definition 1 *A surface $f : |K| \rightarrow \mathbf{R}^3$ is C^1 -continuous, if for every point $x \in |K|$ there exists a regular parameterization $\pi : D \rightarrow f(U_x)$ of $f(U_x)$ over a unit disk D in the plane, where U_x is the neighborhood in $|K|$ of x . A **regular parameterization** π is one that is continuously differentiable, one-to-one, and has a Jacobi matrix of maximum rank.*

The condition that the Jacobi matrix of p has maximum rank is necessary to make sure that we have no degeneracies, i.e., that we really do have a surface, not a curve or point. If $p = (p_1, p_2, p_3)$ and the disc is parameterized by x_1 and x_2 , the condition is that the matrix

$$\begin{pmatrix} \frac{\partial p_1}{\partial x_1} & \frac{\partial p_1}{\partial x_2} \\ \frac{\partial p_2}{\partial x_1} & \frac{\partial p_2}{\partial x_2} \\ \frac{\partial p_3}{\partial x_1} & \frac{\partial p_3}{\partial x_2} \end{pmatrix}$$

have maximal rank (2).

There is another, weaker, definition of smoothness, which is often useful. This definition captures the intuitive idea that the tangent plane to a surface changes continuously near a smooth point. Recall that a tangent plane is uniquely characterized by its normal. This leads us to the following definition:

Definition 2 *A surface $f: |K| \rightarrow \mathbf{R}^3$ is **tangent plane continuous** at $x \in |K|$ if and only if surface normals are defined in a neighborhood around x and there exists a limit of normals at x .*

This is a useful definition, since it is easier to prove surfaces are tangent plane continuous. Tangent plane continuity, however, is weaker than C^1 -continuity.

As a simple example of a surface that is tangent plane continuous but not C^1 -continuous, consider the shape in Figure 3.7. Points in the vicinity of the central point are “wrapped around twice.” There exists a tangent plane at that point, but the surface does not “locally look like a plane.” Formally speaking, there is no regular parameterization of the neighborhood of the central point, even though it has a well-defined tangent plane.

From the previous example, we see how the definition of tangent plane continuity must be strengthened to become C^1 :

Lemma 4 *If a surface is tangent plane continuous at a point and the projection of the surface onto the tangent plane at that point is one-to-one, the surface is C^1 .*

The proof can be found in [35].

3.5 Analysis of Subdivision Surfaces

In this section we discuss how to determine if a subdivision scheme produces smooth surfaces. Typically, it is known in advance that a scheme produces C^1 -continuous (or better) surfaces in the regular setting. For local schemes this means that the surfaces generated on arbitrary meshes are C^1 -continuous away from the extraordinary vertices. We start with a brief discussion of this fact, and then concentrate on analysis of the behavior of the schemes near extraordinary vertices. Our goal is to formulate and provide some motivation for Reif’s sufficient condition for C^1 -continuity of subdivision.

We assume a subdivision scheme defined on a triangular mesh, with certain restrictions on the structure of the subdivision matrix, defined in Section 3.5.2. Similar derivations can be performed without these assumptions, but they become significantly more complicated. We consider the simplest case so as not to obscure the main ideas of the analysis.

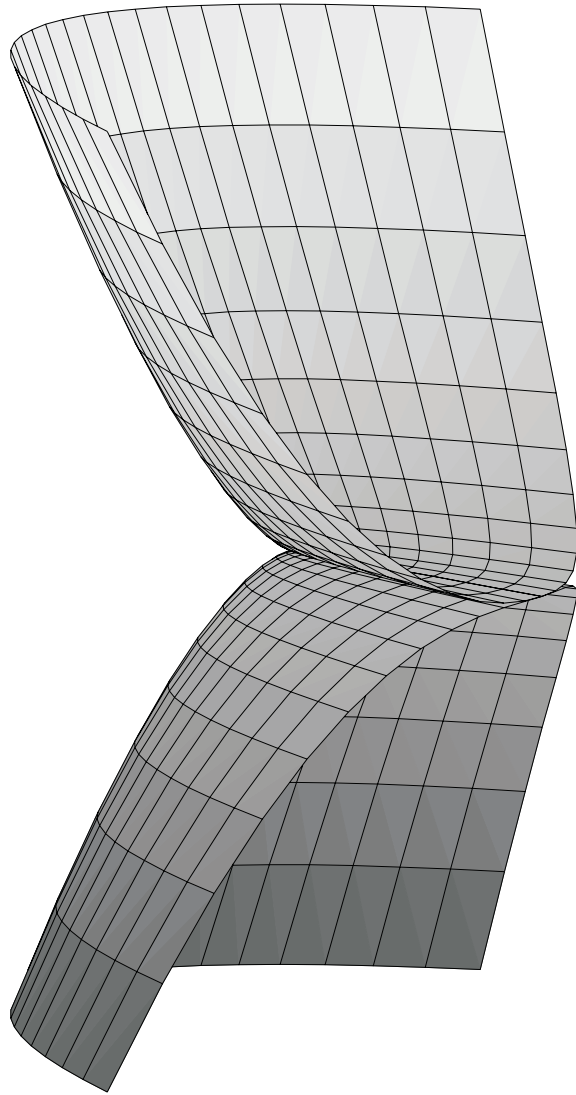

Figure 3.7: *Example of a surface that is tangent plane continuous but not C^1 -continuous.*

3.5.1 C^1 -continuity of Subdivision away from Extraordinary Vertices

Most subdivision schemes are constructed from regular schemes, which are known to produce at least C^1 -continuous surfaces in the regular setting for almost any initial configuration of control points. If our subdivision rules are local, we can take advantage of this knowledge to show that the surfaces generated by the scheme are C^1 -continuous for almost any choice of control points anywhere *away from extraor-*

dinary vertices. We call a subdivision scheme local, if only a finite number of control points is used to compute any new control point, and does not exceed a fixed number for all subdivision levels and all control points.

One can demonstrate, as we did for the curves, that for any triangle T of the domain the surface $f(T)$ is completely determined by only a finite number of control points corresponding to vertices around T . For example, for the Loop scheme, we need only control points for vertices that are adjacent to the triangle. (see Figure 3.8). This is true for triangles at any subdivision level.

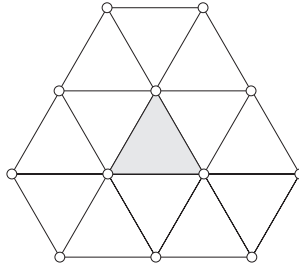

Figure 3.8: *Control set for a triangle for the three-directional box spline.*

To show this, fix a point x of the domain $|K|$ (not necessarily a vertex). For any level j , x is contained in a face of the domain; if x is a vertex, it is shared by several faces. Let $U^j(x)$ be the collection of faces on level j containing x , the *1-neighborhood* of x . The 1-neighborhood of a vertex can be identified with a k -gon in the plane, where k is the valence. We need j to be large enough so that all neighbors of triangles in $U^j(x)$ are free of extraordinary vertices. Unless x is an extraordinary vertex, this is easily achieved. $f(U^j(x))$ will be regular (see Figure 3.9).

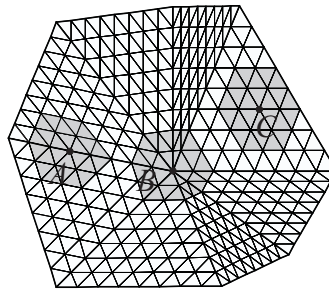

Figure 3.9: *2-neighborhoods (1-neighborhood of 1-neighborhood) of vertices A, C contain only regular vertices; this is not the case for B, which is an extraordinary vertex.*

This means that $f(U^j(x))$ is identical to a part of the surface corresponding to a regular mesh, and is therefore C^1 -continuous for almost any choice of control points, because we have assumed that our

scheme generates C^1 -continuous surfaces over regular meshes.¹

3.5.2 Smoothness Near Extraordinary Vertices

Now that we know that surfaces generated by our scheme are (at least) C^1 -continuous away from the extraordinary vertices, all we have to do is find a smooth parameterization near each extraordinary vertex, or establish that no such parameterization exists.

Consider the extraordinary vertex B in Figure 3.9. After sufficient number of subdivision steps, we will get a 1-neighborhood U^j of B , such that all control points defining $f(U^j)$ are regular, except B itself. This demonstrates that it is sufficient to determine if the scheme generates C^1 -continuous surfaces for a very specific type of domains K : triangulations of the plane which have a single extraordinary vertex in their center, surrounded by regular vertices. We can assume all triangles of these triangulations to be identical (see Figure 3.10) and call such triangulations k -regular.

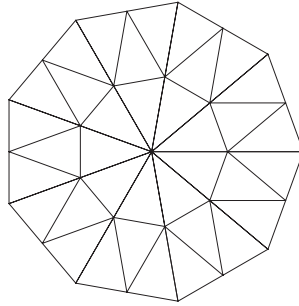

Figure 3.10: k -regular triangulation for $k = 9$.

At first, the task still seems to be very difficult: for any configuration of control vertices, we have to find a parameterization of $f(U^j)$. However, it turns out that the problem can be further simplified.

We outline the idea behind a *sufficient* condition for C^1 -continuity proposed by Reif [26]. This criterion tells us when the scheme is guaranteed to produce C^1 -continuous surfaces, but if it fails, it is still possible that the scheme might be C^1 -continuous.

In addition to the subdivision matrix described in Section 3.3, we need one more tool to formulate the criterion: the *characteristic map*. It turns out that rather than trying to consider all possible surfaces generated by subdivision, it is typically sufficient to look at a single map—the characteristic map.

¹Our argument is informal, and there are certain unusual cases when it fails; see [35] for details.

3.5.3 Characteristic Map

Our observations made in Section 3.3 motivate the definition of the *characteristic map*. Recall that the control points near a vertex converge to a limit configuration independent, up to an affine transformation, from the control points of the original mesh. This limit configuration defines a map. Informally speaking, any subdivision surface generated by a scheme looks near an extraordinary vertex of valence k like the characteristic map of that scheme for valence k .

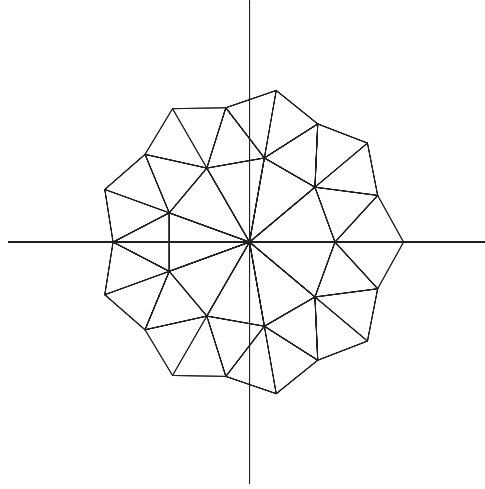

Figure 3.11: *Control set of the characteristic map for $k = 9$.*

Note that when we described subdivision as a function from the plane to \mathbf{R}^3 , we may use control vertices not from \mathbf{R}^3 , but from \mathbf{R}^2 ; clearly, subdivision rules can be applied in the plane rather than in space. Then in the limit we obtain a map from the plane into the plane. The characteristic map is a map of this type.

As we have seen, the configuration of control points near an extraordinary vertex approaches $\mathbf{a}_1x_1 + \mathbf{a}_2x_2$, up to a scaling transformation. This means that the part of the surface defined on the k -gon U^j as $j \rightarrow \infty$, and scaled by the factor $1/\lambda^j$, approaches the surface defined by the vector of control points $\mathbf{a}_1x_1 + \mathbf{a}_2x_2$. Let $f[\mathbf{p}] : U \rightarrow \mathbf{R}^3$ be the limit surface generated by subdivision on U from the control set p .

Definition 3 *The characteristic map of a subdivision scheme for a valence k is the map $\Phi : U \rightarrow \mathbf{R}^2$ generated by the vector of 2D control points $e_1x_1 + e_2x_2$: $\Phi = f[e_1x_1 + e_2x_2]$, where e_1 and e_2 are unit coordinate vectors, and x_1 and x_2 are subdominant eigenvectors.*

Regularity of the characteristic map Inside each triangle of the k -gon U , the map is C^1 : the argument of Section 3.5.1 can be used to show this. Moreover, the map has one-sided derivatives on the boundaries of the triangles, except at the extraordinary vertex, so we can define one-sided Jacobians on the boundaries of triangles too. We will say that the characteristic map is *regular* if its Jacobian is not zero anywhere on U excluding the extraordinary vertex but including the boundaries between triangles.

The regularity of the characteristic map has a geometric meaning: any subdivision surface can be written, up to a scale factor λ^j , as

$$f[\mathbf{p}^j](t) = A\Phi(t) + a(t)O((\lambda_3/\lambda)^j),$$

$t \in U^j$, $a(t)$ a bounded function $U^j \rightarrow \mathbf{R}^3$, and A is a linear transform taking the unit coordinate vectors in the plane to \mathbf{a}_1 and \mathbf{a}_2 . Differentiating along the two coordinate directions t_1 and t_2 in the parametric domain U^j , and taking a cross product, after some calculations, we get the expression for the normal to the surface:

$$\mathbf{n}(t) = (\mathbf{a}_1 \times \mathbf{a}_2)J[\Phi(t)] + O((\lambda_3/\lambda)^{2j})\tilde{a}(t)$$

where $J[\Phi]$ is the Jacobian, and $\tilde{a}(t)$ some bounded vector function on U^j .

The fact that the Jacobian does not vanish for Φ means that the normal is guaranteed to converge to $\mathbf{a}_1 \times \mathbf{a}_2$; therefore, the surface is tangent plane continuous.

Now we need to take only one more step. If, in addition to regularity, we assume that Φ is injective, we can invert it and parameterize any surface as $f(\Phi^{-1}(s))$, where $s \in \Phi(U)$. Intuitively, it is clear that up to a vanishing term this map is just an affine map, and is differentiable. We omit a rigorous proof here. For a complete treatment see [26]; for more recent developments, see [35] and [37].

We arrive at the following condition, which is the basis of smoothness analysis of all subdivision schemes considered in these notes.

Reif's sufficient condition for smoothness. Suppose the eigenvectors of a subdivision matrix form a basis, the largest three eigenvalues are real and satisfy

$$\lambda_0 = 1 > \lambda_1 = \lambda_2 > |\lambda_3|$$

If the characteristic map is regular, then almost all surfaces generated by subdivision are tangent plane continuous; if the characteristic map is also injective, then almost all surfaces generated by subdivision are C^1 -continuous.

Note: Reif's original condition is somewhat different, because he defines the characteristic map on an annular region, rather than on a k -gon. This is necessary for applications, but makes it somewhat more difficult to understand.

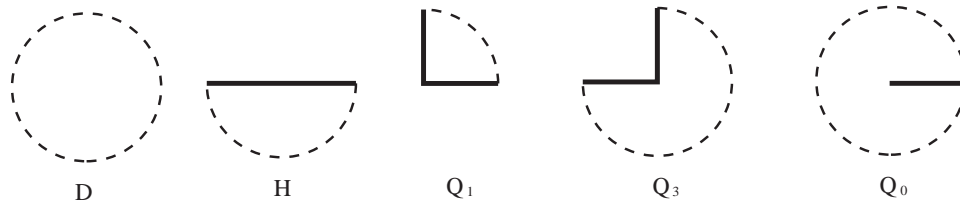

Figure 3.12: *The charts for a surface with piecewise smooth boundary.*

In Chapter 4, we will discuss the most popular stationary subdivision schemes, all of which have been proved to be C^1 -continuous at extraordinary vertices. These proofs are far from trivial: checking the conditions of Reif's criterion is quite difficult, especially checking for injectivity. In most cases calculations are done in symbolic form and use closed-form expressions for the limit surfaces of subdivision [28, 9, 18, 19]. In [36] an interval-based approach is described, which does not rely on closed-form expressions for limit surfaces, and can be applied, for example, to interpolating schemes.

3.6 Piecewise-smooth surfaces and subdivision

Piecewise smooth surfaces. So far, we have assumed that we consider only closed smooth surfaces. However, in reality we typically need to model more general classes of surfaces: surfaces with boundaries, which may have corners, creases, cusps and other features. One of the significant advantages of subdivision is that it is possible to introduce features into surfaces using simple modifications of rules. Here we briefly describe a class of surfaces (*piecewise smooth surfaces*) which appears to be adequate for many applications. This is the class of surfaces that includes, for example, quadrilateral free-form patches, and other common modeling primitives. At the same time, we have excluded from consideration surfaces with various other types of singularities. To generate surfaces from this class, in addition to vertex and edge rules such as the Loop rules (Section 3.1), we need to define several other types of rules.

To define piecewise smooth surfaces, we start with smooth surfaces that have a piecewise-smooth boundary. For simplicity, assume that our surfaces do not have self-intersections. Recall that for closed C^1 -continuous surface M in \mathbf{R}^3 each point has a neighborhood that can be smoothly deformed into an open planar disk D .

A *surface with a smooth boundary* is defined in a similar way, but the neighborhoods of points on the boundary can be smoothly deformed into a half-disk H , with closed boundary. To define a surface with piecewise smooth boundaries, we introduce two additional types of local charts: concave and convex corner charts, Q_3 and Q_1 (Figure 3.12). Thus, a C^1 -continuous surface with piecewise smooth boundary locally looks like one of the domains D , H , Q_1 and Q_3 .

Piecewise-smooth surfaces are the surfaces that can be constructed out of surfaces with piecewise smooth boundaries joined together.

If the resulting surface is not C^1 -continuous at the common boundary of two pieces, this common boundary is a crease. We allow two adjacent smooth segments of a boundary to be joined, producing a crease ending in a *dart* (cf. [10]). For dart vertices an additional chart Q_0 is required; the surface near a dart can be deformed into this chart smoothly everywhere except at an open edge starting at the center of the disk.

Subdivision schemes for piecewise smooth surfaces. An important observation for constructing subdivision rules for the boundary is that the last two corner types are not equivalent, that is, there is no smooth *non-degenerate* map from Q_1 to Q_3 . It follows from the theory of subdivision [35], that a single subdivision rule cannot produce both types of corners. In general, any complete set of subdivision rules should contain separate rules for all chart types. Most, if not all, known schemes provide rules for charts of type D and H (smooth boundary and interior vertices); rules for charts of type Q_1 and Q_0 (convex corners and darts) are typically easy to construct; however, Q_3 (concave corner) is more of a challenge, and no rules were known until recently.

In Chapter 4 we present descriptions of various rules for smooth (not piecewise smooth) surfaces with boundary. For extensions of the Loop and Catmull-Clark schemes including concave corner rules, see [2].

Interpolating boundaries. Quite often our goal is not just to generate a smooth surface of a given topological type approximating or interpolating an initial mesh with boundary, but to interpolate a given set of boundary or even an arbitrary set of curves. In this case, one can use a technique developed by A. Levin [13, 14, 15]. The advantage of this approach is that the interpolated curves need not be generated by subdivision; one can easily create blend subdivision surfaces with different types of parametric surfaces (for a example, NURBS).

Chapter 4

Subdivision Zoo

Denis Zorin, New York University

4.1 Overview of Subdivision Schemes

In this section we describe most known stationary subdivision schemes generating C^1 -continuous surfaces on arbitrary meshes. Without doubt, our discussion is not exhaustive even as far as stationary schemes are concerned. There are even wholly different classes of subdivision schemes, most importantly variational schemes, that we do not discuss here (see Chapter 9).

At first glance, the variety of existing schemes might appear chaotic. However, there is a straightforward way to classify most of the schemes based on four criteria:

- the type of refinement rule (face split or vertex split);
- the type of generated mesh (triangular or quadrilateral);
- whether the scheme is approximating or interpolating;
- smoothness of the limit surfaces for regular meshes (C^1 , C^2 etc.)

The following table shows this classification:

Face split		
	<i>Triangular meshes</i>	<i>Quad. meshes</i>
<i>Approximating</i>	Loop (C^2)	Catmull-Clark (C^2)
<i>Interpolating</i>	Mod. Butterfly (C^1)	Kobbelt (C^1)

Vertex split
Doo-Sabin, Midedge (C^1)
Biquartic (C^2)

Out of recently proposed schemes, $\sqrt{3}$ subdivision [12], and subdivision on $4 - k$ meshes [31, 32] do not fit into this classification. In this survey, we focus on the better-known and established schemes, and this classification is sufficient for most purposes. It can be extended to include the new schemes, as discussed in Section 4.9.

The table shows that there is little replication in functionality: most schemes produce substantially different types of surfaces. Now we consider our classification criteria in greater detail.

First, we note that each subdivision scheme defined on meshes of arbitrary topology is based on a *regular subdivision scheme*, for example, one based on splines. Our classification is primarily a classification of regular subdivision schemes—once such a scheme is fixed, additional rules have to be specified only for extraordinary vertices or faces that cannot be part of a regular mesh.

Mesh Type. Regular subdivision schemes act on regular control meshes, that is, vertices of the mesh correspond to regularly spaced points in the plane. However, the faces of the mesh can be formed in different ways. For a regular mesh, it is natural to use faces that are identical. If, in addition, we assume that the faces are regular polygons, it turns out that there are only three ways to choose the face polygons: we can use squares, equilateral triangles and regular hexagons. Meshes consisting of hexagons are not very common, and the first two types of tiling are the most convenient for practical purposes. These lead to two types of regular subdivision schemes: those defined for quadrilateral tilings, and those defined for triangular tilings.

Face Split and Vertex Split. Once the tiling of the plane is fixed, we have to define how a refined tiling is related to the original tiling. There are two main approaches that are used to generate a refined tiling: one is *face split* and the other is *vertex split* (see Figure 4.1). The schemes using the first method are often called *primal*, and the schemes using the second method are called *dual*. In the first case, each face of a triangular or a quadrilateral mesh is split into four. Old vertices are retained, new vertices are inserted on the edges, and for quadrilaterals, an additional vertex is inserted for each face. In the second case, for each old vertex, several new vertices are created, one for each face adjacent to the vertex. A new face is created for each edge and old faces are retained; in addition, a new face is created for each vertex. For quadrilateral tilings, this results in tilings in which each vertex has valence 4. In the case of triangles vertex split (dual) schemes results in non-nesting hexagonal tilings. In this sense quadrilateral tilings are special: they support both primal and dual subdivision schemes easily (see also Chapter 5).

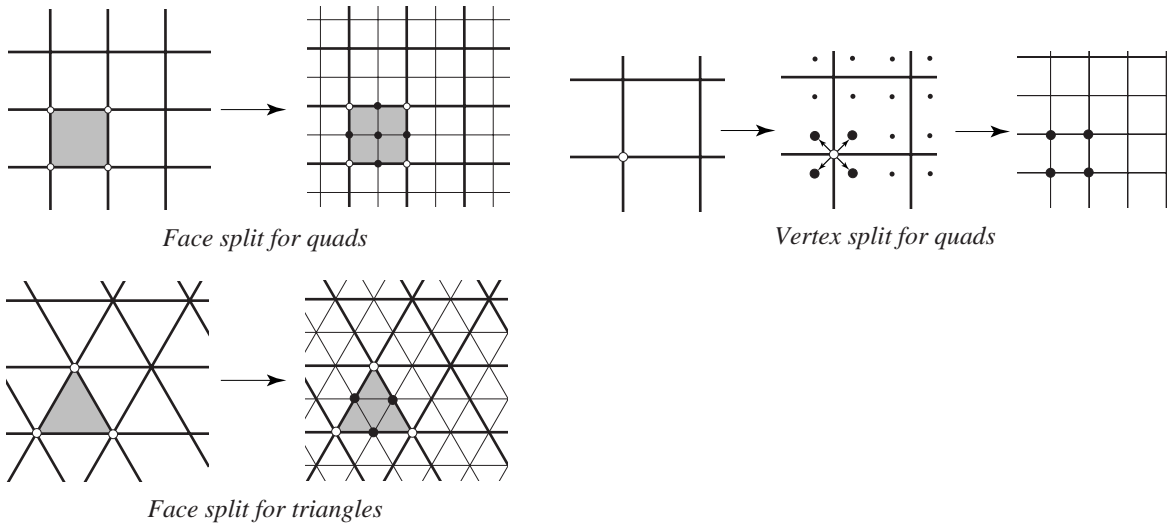

Figure 4.1: *Different refinement rules.*

Approximation vs. Interpolation. Face-split schemes can be interpolating or approximating. Vertices of the coarser tiling are also vertices of the refined tiling. For each vertex a sequence of control points, corresponding to different subdivision levels, is defined. If all points in the sequence are the same, we say that the scheme is interpolating. Otherwise, we call it approximating. Interpolation is an attractive feature in more than one way. First, the original control points defining the surface are also points of the limit surface, which allows one to control it in a more intuitive manner. Second, many algorithms can be considerably simplified, and many calculations can be performed “in place.” Unfortunately, the quality of these surfaces is not as high as the quality of surfaces produced by approximating schemes, and the schemes do not converge as fast to the limit surface as the approximating schemes.

4.1.1 Notation and Terminology

Here we summarize the notation that we use in subsequent sections. Some of it was already introduced earlier.

Regular and extraordinary vertices. We have already seen that subdivision schemes defined on triangular meshes create new vertices of valence 6 in the interior. On the boundary, the newly created vertices have valence 4. Similarly, on quadrilateral meshes both face-split and vertex-split schemes create only vertices of valence 4 in the interior, and 3 on the boundary. Hence, after several subdivision steps, most vertices in a mesh will have one of these valences (6 in the interior, 4 on the boundary for triangular meshes, 4 in the interior, 3 on the boundary for quadrilateral). The vertices with these valences are called *regular* and vertices of other valences *extraordinary*.

Notation for vertices near a fixed vertex. In Figure 4.2 we show the notation that we use for control points of quadrilateral and triangular subdivision schemes near a fixed vertex. Typically, we need it for extraordinary vertices. We also use it for regular vertices when describing calculations of limit positions and tangent vectors.

Odd and even vertices. For face-split (primal) schemes, the vertices of the coarser mesh are also vertices of the refined mesh. For any subdivision level, we call all new vertices that are created at that level, *odd vertices*. This term comes from the one-dimensional case, when vertices of the control polygons can be enumerated sequentially and on any level the newly inserted vertices are assigned odd numbers. The vertices inherited from the previous level are called *even*. (See also Chapter 2).

Face and edge vertices. For triangular schemes (Loop and Modified Butterfly), there is only one type of odd vertex. For quadrilateral schemes, some vertices are inserted when edges of the coarser mesh are split, other vertices are inserted for a face. These two types of odd vertices are called *edge* and *face* vertices respectively.

Boundaries and creases. Typically, special rules have to be specified on the boundary of a mesh. These rules are commonly chosen in such a way that the boundary curve of the limit surface does not depend on any interior control vertices, and is smooth or piecewise smooth (C^1 or C^2 -continuous). The same rules can be used to introduce sharp features into C^1 -surfaces: some interior edges can be *tagged* as crease edges, and boundary rules are applied for all vertices that are inserted on such edges.

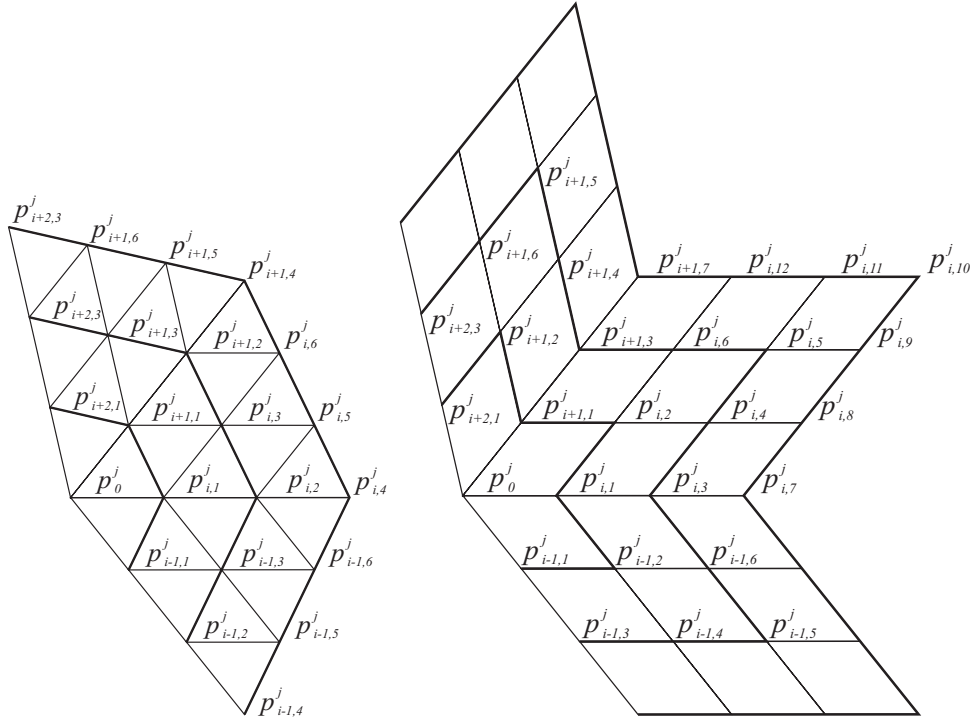

Figure 4.2: Enumeration of vertices of a mesh near an extraordinary vertex; for a boundary vertex, the 0 – th sector is adjacent to the boundary.

Masks. We often specify a subdivision rule by providing its *mask*. The mask is a picture showing the control points used to compute a new control point, which we usually denote with a black dot. The numbers next to the vertices are the coefficients of the subdivision rule.

4.2 Loop Scheme

The Loop scheme is a simple approximating face-split scheme for triangular meshes proposed by Charles Loop [16]. C^1 -continuity of this scheme for valences up to 100, including the boundary case, was proved by Schweitzer [28]. The proof for all valences can be found in [35].

The scheme is based on the *three-directional box spline*, which produces C^2 -continuous surfaces over regular meshes. The Loop scheme produces surfaces that are C^2 -continuous everywhere except at extraordinary vertices, where they are C^1 -continuous. Hoppe, DeRose, Duchamp et al. [10] proposed a piecewise C^1 -continuous extension of the Loop scheme, with special rules defined for edges; in [2, 3],

the boundary rules are further improved, and new rules for concave corners and normal modification are proposed.

The scheme can be applied to arbitrary polygonal meshes, after the mesh is converted to a triangular mesh, for example, by triangulating each polygonal face.

Subdivision Rules. The masks for the Loop scheme are shown in Figure 4.3. For boundaries and edges tagged as *crease* edges, special rules are used. These rules produce a cubic spline curve along the boundary/crease. The curve only depends on control points on the boundary/crease.

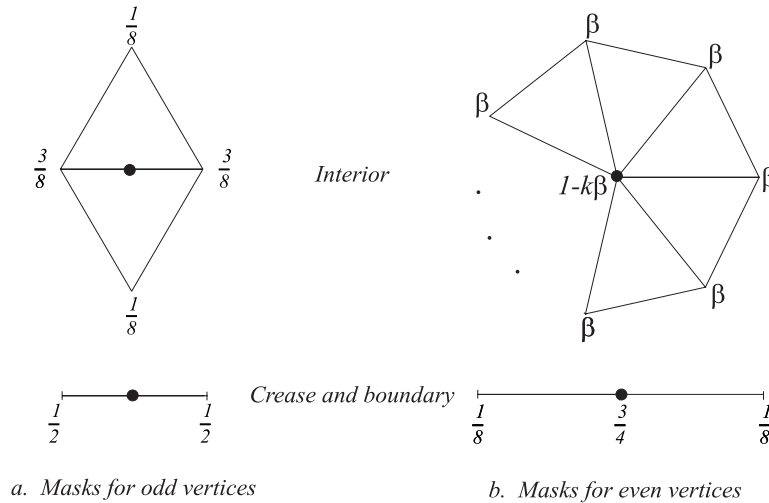

Figure 4.3: *Loop subdivision: in the picture above, β can be chosen to be either $\frac{1}{n}(5/8 - (\frac{3}{8} + \frac{1}{4} \cos \frac{2\pi}{n})^2)$ (original choice of Loop [16]), or, for $n > 3$, $\beta = \frac{3}{8n}$ as proposed by Warren [33]. For $n = 3$, $\beta = 3/16$ can be used.*

In [10], the rules for extraordinary crease vertices and their neighbors on the crease were modified to produce tangent plane continuous surfaces on either side of the crease (or on one side of the boundary). In practice, this modification does not lead to a significant difference in the appearance of the surface. At the same time, as a result of this modification, the crease curve becomes dependent on the valences of vertices on the curve. This is a disadvantage in situations when two surfaces have to be joined together along a boundary. It appears that for display purposes it is safe to use the rules shown in Figure 4.3. Although the surface will not be formally C^1 -continuous near vertices of valence greater than 7, the result will be visually indistinguishable from a C^1 -surface obtained with modified rules, with the additional advantage of independence of the boundary from the interior.

If it is necessary to ensure C^1 -continuity, a different modification can be used. Rather than modifying the rules for a crease, and making them dependent on the valence of vertices, we modify rules for interior odd vertices adjacent to an extraordinary vertex. For $n < 7$, no modification is necessary. For $n > 7$, it is sufficient to use the mask shown in Figure 4.4. Then the limit surface can be shown to be C^1 -continuous at the boundary. A better, although slightly more complex modification can be found in [3, 2]: instead of $\frac{1}{2}$ and $\frac{1}{4}$ we can use $\frac{1}{4} + \frac{1}{4} \cos \frac{2\pi}{k-1}$ and $\frac{1}{2} - \frac{1}{4} \cos \frac{2\pi}{k-1}$ respectively, where k is the valence of the boundary/crease vertex.

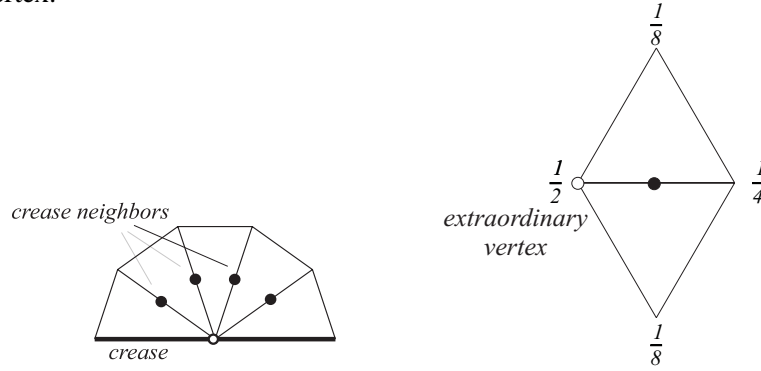

Figure 4.4: *Modified rule for odd vertices adjacent to a boundary/crease extraordinary vertex (Loop scheme).*

Tangent Vectors. The rules for computing tangent vectors for the Loop scheme are especially simple. To compute a pair of tangent vectors at an interior vertex, use

$$\begin{aligned}
 t_1 &= \sum_{i=0}^{k-1} \cos \frac{2\pi i}{k} p_{i,1} \\
 t_2 &= \sum_{i=0}^{k-1} \sin \frac{2\pi i}{k} p_{i,1}.
 \end{aligned}
 \tag{4.1}$$

These formulas can be applied to the control points at any subdivision level.

Quite often, the tangent vectors are used to compute a normal. The normal obtained as the cross product $t_1 \times t_2$ can be interpreted geometrically. This cross product can be written as a weighted sum of normals to all possible triangles formed by $p_0, p_{i,1}, p_{l,1}, i, l = 0 \dots k-1, i \neq l$. The standard way of obtaining vertex normals for a mesh by averaging the normals of triangles adjacent to a vertex, can be regarded as a first approximation to the normals given by the formulas above. At the same time, it is worth observing that computing normals as $t_1 \times t_2$ is less expensive than averaging the normals of

triangles. The geometric nature of the normals obtained in this way suggests that they can be used to compute approximate normals for other schemes, even if the precise normals require more complicated expressions.

At a boundary vertex, the tangent along the curve is computed using $t_{along} = p_{0,1} - p_{k-1,1}$. The tangent across the boundary/crease is computed as follows [10]:

$$\begin{aligned}
t_{across} &= p_{0,1} + p_{1,1} - 2p_0 \quad \text{for } k = 2 \\
t_{across} &= p_{2,1} - p_0 \quad \text{for } k = 3 \\
t_{across} &= \sin \theta (p_{0,1} + p_{k-1,1}) + (2 \cos \theta - 2) \sum_{i=1}^{k-2} \sin i\theta p_{i,1} \quad \text{for } k \geq 4
\end{aligned} \tag{4.2}$$

where $\theta = \pi/(k-1)$. These formulas apply whenever the scheme is tangent plane continuous at the boundary; it does not matter which method was used to ensure tangent plane continuity.

Limit Positions. Another set of simple formulas allows one to compute limit positions of control points for a fixed vertex, that is, the limit $\lim_{j \rightarrow \infty} p^j$ for a fixed vertex. For interior vertices, the mask for computing the limit value at an interior vertex is the same as the mask for computing the value on the next level, with β replaced by $\chi = \frac{1}{3/8\beta+n}$.

For boundary and crease vertices, the formula is always

$$p_0^\infty = \frac{1}{5}p_{0,1} + \frac{3}{5}p_0 + \frac{1}{5}p_{1,k-1}$$

This expression is similar to the rule for even boundary vertices, but with different coefficients. However, different formulas have to be used if the rules on the boundary are modified as in [10].

4.3 Modified Butterfly Scheme

The Butterfly scheme was first proposed by Dyn, Gregory and Levin in [7]. The original Butterfly scheme is defined on arbitrary triangular meshes. However, the limit surface is not C^1 -continuous at extraordinary points of valence $k = 3$ and $k > 7$ [35], while it is C^1 on regular meshes.

Unlike approximating schemes based on splines, this scheme does not produce piecewise polynomial surfaces in the limit. In [39] a modification of the Butterfly scheme was proposed, which guarantees that the scheme produces C^1 -continuous surfaces for arbitrary meshes (for a proof see [35]). The scheme is known to be C^1 but not C^2 on regular meshes. The masks are shown in Figure 4.5.

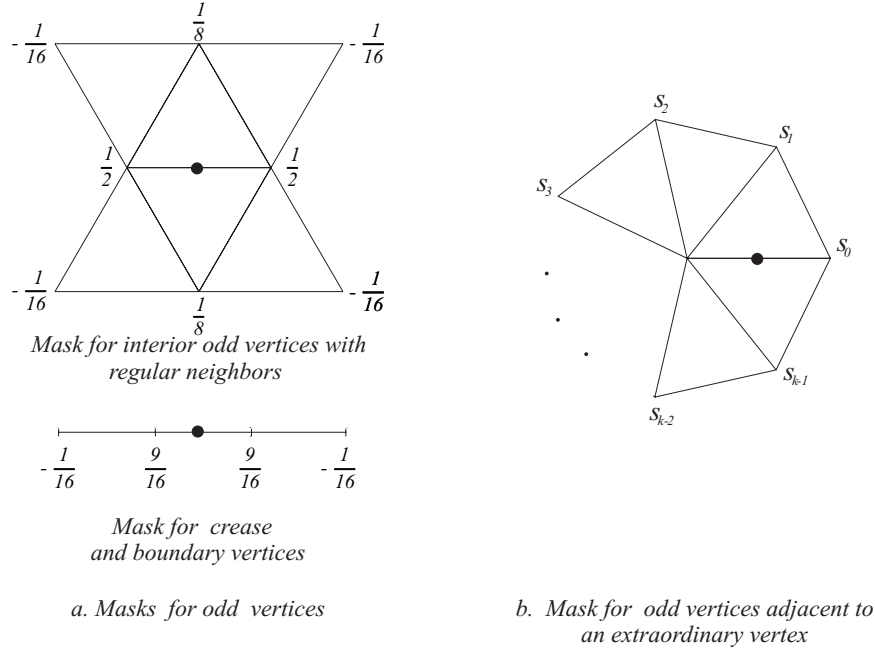

Figure 4.5: *Modified Butterfly subdivision. The coefficients s_i are $\frac{1}{k} \left(\frac{1}{4} + \cos \frac{2i\pi}{k} + \frac{1}{2} \cos \frac{4i\pi}{k} \right)$ for $k > 5$. For $k = 3$, $s_0 = \frac{5}{12}$, $s_{1,2} = -\frac{1}{12}$; for $k = 4$, $s_0 = \frac{3}{8}$, $s_2 = -\frac{1}{8}$, $s_{1,3} = 0$.*

The tangent vectors at extraordinary interior vertices can be computed using the same rules as for the Loop scheme. For regular vertices, the formulas are more complex: in this case, we have to use control points in a 2-neighborhood of a vertex. If the control points are arranged into a vector $p = [p_0, p_{0,1}, p_{1,1}, \dots, p_{5,1}, p_{0,2}, p_{1,2}, p_{2,2}, \dots, p_{5,3}]$ of length 19, then the tangents are given by scalar products $(l_1 \cdot p)$ and $(l_2 \cdot p)$, where the vectors l_1 and l_2 are

$$\begin{aligned}
 l_1 &= \left[0, 16, 8, -8, -16, -8, 8, -4, 0, 4, 4, 0, -4, 1, \frac{1}{2}, -\frac{1}{2}, -1, -\frac{1}{2}, \frac{1}{2} \right] \\
 l_2 &= \sqrt{3} \left[0, 0, 8, 8, 0, -8, -8, -\frac{4}{3}, -\frac{8}{3}, -\frac{4}{3}, \frac{4}{3}, \frac{8}{3}, \frac{4}{3}, 0, \frac{1}{2}, \frac{1}{2}, 0, -\frac{1}{2}, -\frac{1}{2} \right]
 \end{aligned} \tag{4.3}$$

Because the scheme is interpolating, no formulas are needed to compute the limit positions: all control points are on the surface. On boundaries and creases the four-point subdivision scheme, also shown in Figure 4.5, is used [6]. To achieve C^1 -continuity on the boundary, special coefficients have to be used for crease neighbors, similar to the case of the Loop scheme. One can also adopt a simpler solution: obtain missing vertices by reflection whenever the butterfly stencil is incomplete, and always use the standard Butterfly rule, when there is no adjacent interior extraordinary vertex. This approach however results in

visible singularities. For completeness, we describe a set of rules that ensure C^1 -continuity, as these rules were not previously published.

Boundary Rules. The rules extending the Butterfly scheme to meshes with boundary are somewhat more complex, because the stencil of the Butterfly scheme is larger. A number of different cases have to be considered separately: first, there is a number of ways in which one can chop off triangles from the butterfly stencil; in addition, the neighbors of the vertex that we are trying to compute can be either regular or extraordinary.

A complete set of rules for a mesh with boundary (up to head-tail permutations), includes 7 types of rules: regular interior, extraordinary interior, regular interior-crease, regular crease-crease 1, regular crease-crease 2, crease, and extraordinary crease neighbor; see Figures 4.5, 4.6, and 4.7. To put it all into a system, the main cases can be classified by the types of head and tail vertices of the edge on which we add a new vertex.

Recall that an interior vertex is a regular if its valence is 6, and a crease vertex is regular if its valence is 4. The following table shows how the type of rule to be applied to compute a *non-crease* vertex is determined from the valence of the adjacent vertices and whether they are on a crease or not. As we have already mentioned, the 4-point rule is used to compute new crease vertices. The only case when additional information is necessary, is when both neighbors are regular crease vertices. In this case the decision is based on the number of crease edges of the adjacent triangles (Figure 4.6).

Head	Tail	Rule
regular interior	regular interior	standard rule
regular interior	regular crease	regular interior-crease
regular crease	regular crease	regular crease-crease 1 or 2
extraordinary interior	extraordinary interior	average two extraordinary rules
extraordinary interior	extraordinary crease	same
extraordinary crease	extraordinary crease	same
regular interior	extraordinary interior	interior extraordinary
regular interior	extraordinary crease	crease extraordinary
extraordinary interior	regular crease	interior extraordinary
regular crease	extraordinary crease	crease extraordinary

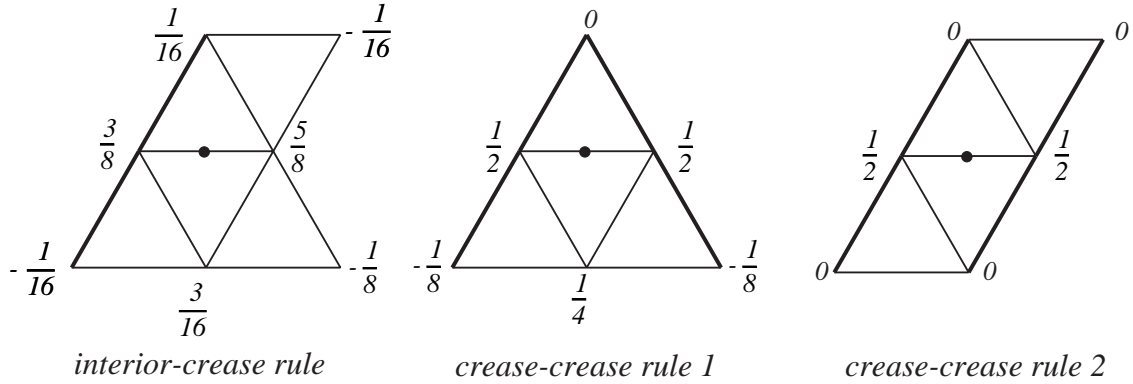

Figure 4.6: Regular Modified Butterfly boundary/crease rules.

The extraordinary crease rule (Figure 4.7) uses coefficients c_{ij} , $j = 0 \dots k$, to compute the vertex number i in the ring, when counted from the boundary. Let $\theta_k = \pi/(k-1)$. The following formulas define c_{ij} :

$$\begin{aligned}
 c_0 &= 1 - (1/(k-1)) \sin \theta_k \sin i\theta_k / (1 - \cos \theta_k) \\
 c_{i0} &= c_{ik} = 1/4 \cos i\theta_k - (1/4(k-1)) \sin 2\theta_k \sin 2\theta_k i / (\cos \theta_k - \cos 2\theta_k) \\
 c_{ij} &= (1/k) (\sin i\theta_k \sin j\theta_k + (1/2) \sin 2i\theta_k \sin 2j\theta_k)
 \end{aligned}$$

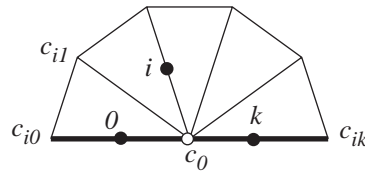

Figure 4.7: Modified Butterfly rules for neighbors of a crease/boundary extraordinary vertex.

4.4 Catmull-Clark Scheme

The Catmull-Clark scheme was described in [4]. It is based on the tensor product bicubic spline. The masks are shown in Figure 4.8. The scheme produces surfaces that are C^2 everywhere except at extraordinary vertices, where they are C^1 . The tangent plane continuity of the scheme was analyzed by Ball and Storry [1], and C^1 -continuity by Peters and Reif [18]. The values of α and β can be chosen from a wide range (see Figure 4.10). On the boundary, using the coefficients for the cubic spline produces acceptable

results, however, the resulting surface formally is not C^1 -continuous. A modification similar to the one performed in the case of Loop subdivision makes the scheme C^1 -continuous (Figure 4.9). Again, a better, although a bit more complicated choice of coefficients is $\frac{3}{8} + \frac{1}{4} \cos \frac{2\pi}{k-1}$ instead of $\frac{5}{8}$ and $\frac{3}{8} - \frac{1}{4} \cos \frac{2\pi}{k-1}$ instead of $\frac{1}{8}$. See [38] for further details about the behavior on the boundary.

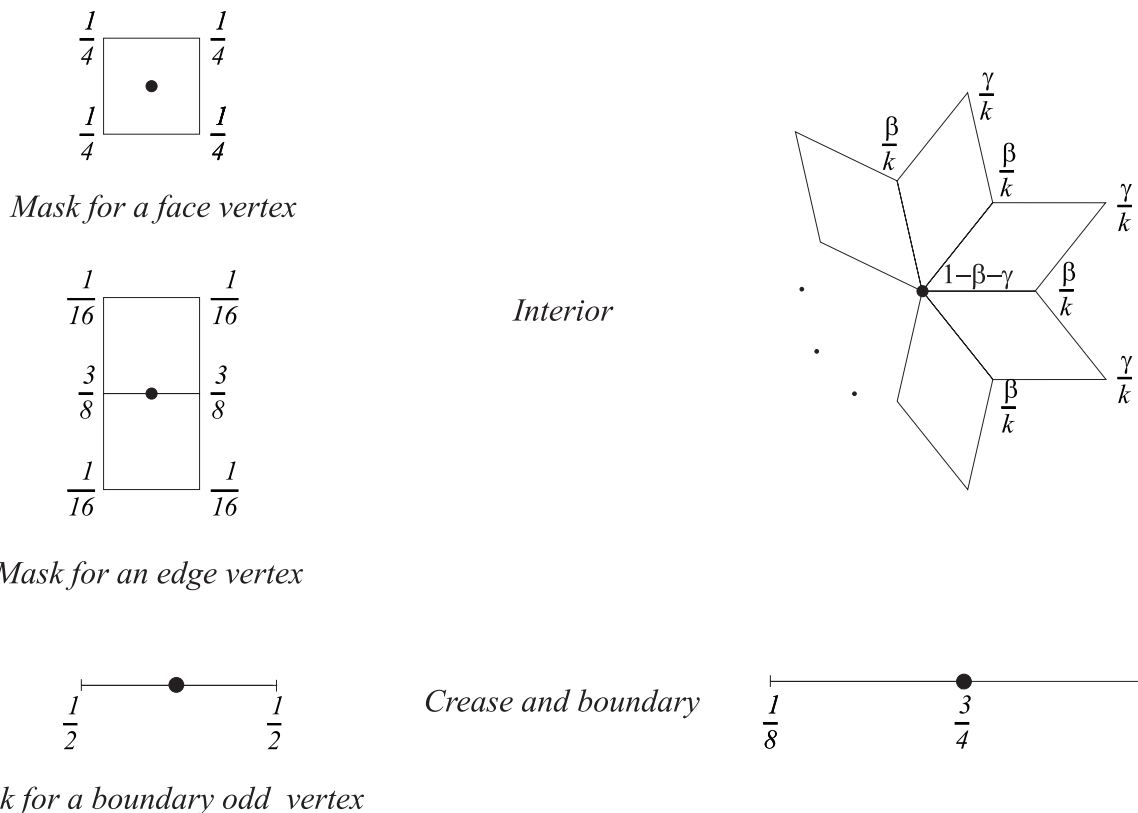

Figure 4.8: *Catmull-Clark subdivision. Catmull and Clark [4] suggest the following coefficients for rules at extraordinary vertices: $\beta = \frac{3}{2k}$ and $\gamma = \frac{1}{4k}$*

The rules of Catmull-Clark scheme are defined for meshes with quadrilateral faces. Arbitrary polygonal meshes can be reduced to a quadrilateral mesh using a more general form of Catmull-Clark rules [4]:

- a face control point for an n -gon is computed as the average of the corners of the polygon;

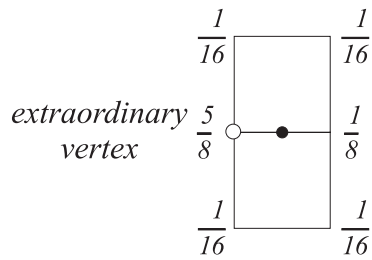

Figure 4.9: Modified rule for odd vertices adjacent to a boundary extraordinary vertex (Catmull-Clark scheme).

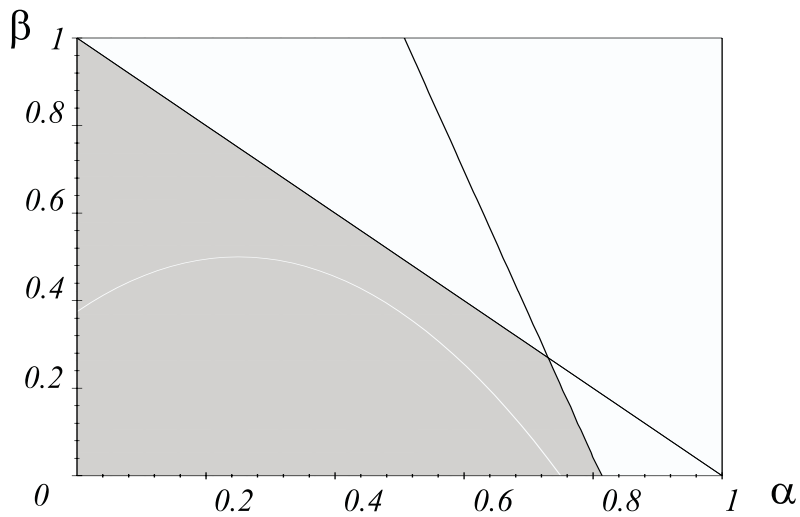

Figure 4.10: Ranges for coefficients α and β of the Catmull-Clark scheme; $\alpha = 1 - \gamma - \beta$ is the coefficient of the central vertex.

- an edge control point as the average of the endpoints of the edge and newly computed face control points of adjacent faces;
- the formula for even control points can be chosen in different ways; the original formula is

$$p_0^{j+1} = \frac{k-2}{k} p_0^j + \frac{1}{k^2} \sum_{i=0}^{k-1} p_{i,1}^j + \frac{1}{k^2} \sum_{i=0}^{k-1} p_{i,2}^{j+1}$$

using the notation of Figure 4.2. Note that face control points on level $j + 1$ are used.

4.5 Kobbelt Scheme

This interpolating scheme was described by Kobbelt in [11]. For regular meshes, it reduces to the tensor product of the four point scheme. C^1 -continuity of this scheme for interior vertices for all valences is proven in [36].

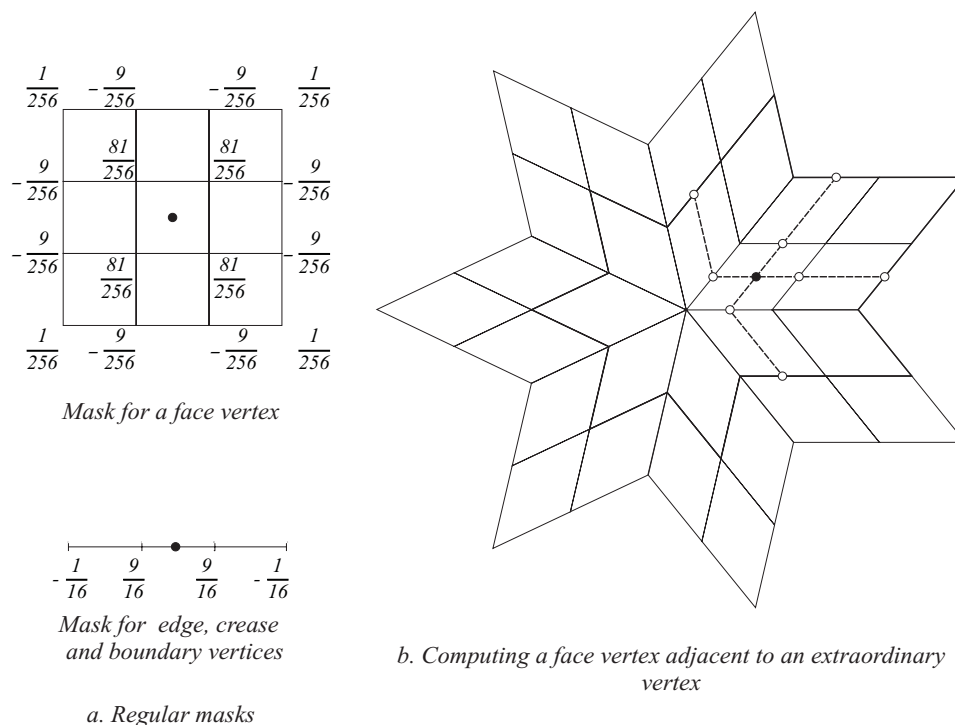

Figure 4.11: *Kobbelt subdivision.*

Crucial for the construction of this scheme is the observation (valid for any tensor-product scheme) that the face control points can be computed in two steps: first, all edge control points are computed. Next, face vertices are computed using the *edge rule* applied to a sequence of edge control points on the same level. As shown in Figure 4.11, there are two ways to compute a face vertex in this way. In the regular case, the result is the same. Assuming this method of computing all face control points, only one rule of the regular scheme is modified: the edge odd control points adjacent to an extraordinary vertex

are computed differently. Specifically,

$$\begin{aligned}
 p_{i,1}^{j+1} &= \left(\frac{1}{2} - w\right)p_0^j + \left(\frac{1}{2} - w\right)p_{i,1}^j + wp_i^j + wp_{i,3}^j \\
 v_i^j &= \frac{4}{k} \sum_{i=0}^{k-1} p_{i,1}^j - (p_{i-1,1}^j + p_{i,1}^j + p_{i+1,1}^j) - \frac{w}{1/2 - w} (p_{i-2,2}^j + p_{i-1,2}^j + p_{i,2}^j + p_{i+1,2}^j) + \frac{4w}{(1/2 - w)k} \sum_{i=0}^{k-1} p_{i,2}^j
 \end{aligned}
 \tag{4.4}$$

where $w = -1/16$ (also, see Figure 4.2 for notation). On the boundaries and creases, the four point subdivision rule is used.

Unlike other schemes, eigenvectors of the subdivision matrix cannot be computed explicitly; hence, there are no precise expressions for tangents. In any case, the effective support of this scheme is too large for such formulas to be of practical use: typically, it is sufficient to subdivide several times and then use, for example, the formulas for the Loop scheme (see discussion in the section on the Loop scheme).

For more details on this scheme, see the part of the notes written by Leif Kobbelt.

4.6 Doo-Sabin and Midedge Schemes

Doo-Sabin subdivision is quite simple conceptually: there is no distinction between odd and even vertices, and a single mask is sufficient to define the scheme. A special rule is required only for the boundaries, where the limit curve is a quadratic spline. It was observed by Doo that this can also be achieved by replicating the boundary edge, i.e., creating a quadrilateral with two coinciding pairs of vertices. Nasri [17] describes other ways of defining rules for boundaries. The rules for the Doo-Sabin scheme are shown in Figure 4.12. C^1 -continuity for schemes similar to the Doo-Sabin schemes was analyzed by Peters and Reif [18].

An even simpler scheme was proposed by Habib and Warren [9] and by Peters and Reif [19]: this scheme uses even smaller stencils than the Doo-Sabin scheme; for regular vertices, only three control points are used (Figure 4.13).

A remarkable property of both Midedge and Doo-Sabin subdivision is that the interior rules, at least in the regular case, can be decomposed into a sequence of averaging steps, as shown in Figures 4.14 and Figures 4.15

In both cases the averaging procedure generalizes to arbitrary meshes. However, the edge averaging procedure, as it was established in [19], does not result in well-behaved surfaces, when applied to arbitrary meshes. In contrast, centroid averaging, when applied to arbitrary meshes, results precisely in the

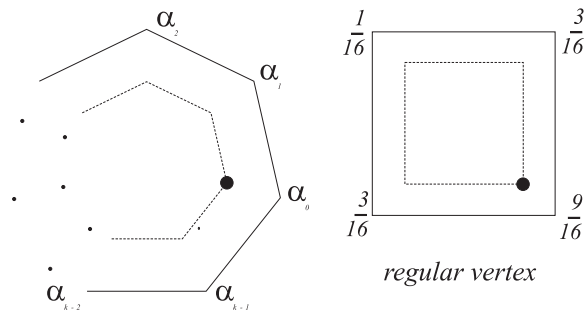

Mask for interior vertices

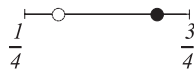

Mask for boundary vertices

Figure 4.12: *Doo-Sabin subdivision*. The coefficients are defined by the formulas $\alpha_0 = 1/4 + 5/4k$ and $\alpha_i = (3 + 2\cos(2i\pi/k))/4k$, for $i = 1 \dots k - 1$. Another choice of coefficients was proposed by Catmull and Clark: $\alpha_0 = 1/2 + 1/4k$, $\alpha_1 = \alpha_{k-1} = 1/8 + 1/4k$, and $\alpha_i = 1/4k$ for $i = 2 \dots k - 2$.

Catmull-Clark variant of the Doo-Sabin scheme. Another important observation is that centroid averaging can be applied more than once. This idea provides us with a different view of a class of quadrilateral subdivision schemes, which we now discuss in detail.

4.7 Uniform Approach to Quadrilateral Subdivision

As we have observed in the previous section, the Doo-Sabin scheme can be represented as midpoint subdivision followed by a centroid averaging step. What if we apply the centroid averaging step one more time? The result is a primal subdivision scheme, in the regular case coinciding with Catmull-Clark. In the irregular case the stencil of the resulting scheme is the same as the stencil of Catmull-Clark, but the coefficients α and β used in the vertex rule are different. However, the new coefficients also result in a well-behaved scheme producing surfaces only slightly different from Catmull-Clark.

Clearly, we can apply the centroid averaging to midpoint-subdivided mesh any number of times, obtaining in the regular case splines of higher and higher degree. Similar observations were made independently by a number of people: [34, 29, 30].

For arbitrary meshes we will get subdivision schemes which have higher smoothness away from iso-

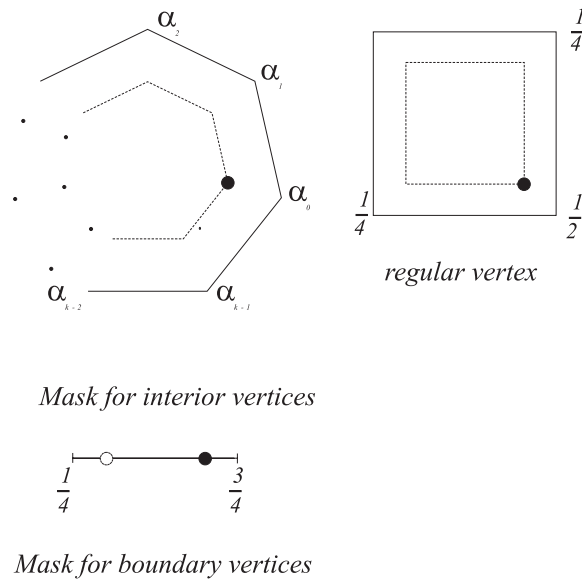

Figure 4.13: *Midedge subdivision. The coefficients are defined by the formulas $\alpha_i = 2 \sum_{j=0}^{\bar{n}} 2^{-j} \cos \frac{2\pi i j}{k}$, $\bar{n} = \lfloor \frac{n-1}{2} \rfloor$ for $i = 0 \dots k-1$*

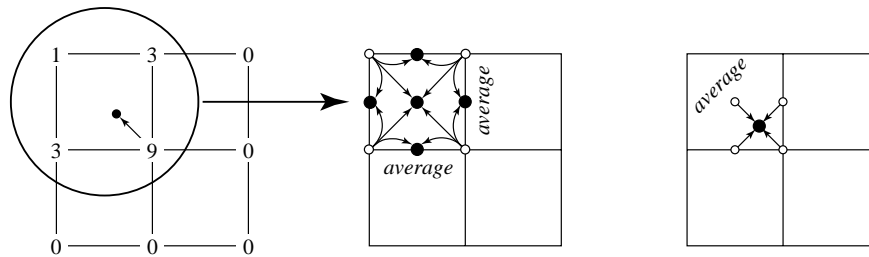

Figure 4.14: *The subdivision stencil for Doo-Sabin subdivision in the regular case (left). It can be understood as midpoint subdivision followed by averaging. At the averaging step the centroid of each face is computed; then the barycenters are connected to obtain a new mesh. This procedure generalizes without changes to arbitrary meshes.*

lated points on the surface. Unfortunately, smoothness at the extraordinary vertices (for primal schemes) and at the centroids of faces (for dual schemes) remains, in general, C^1 .

Our observations are summarized in the following table:

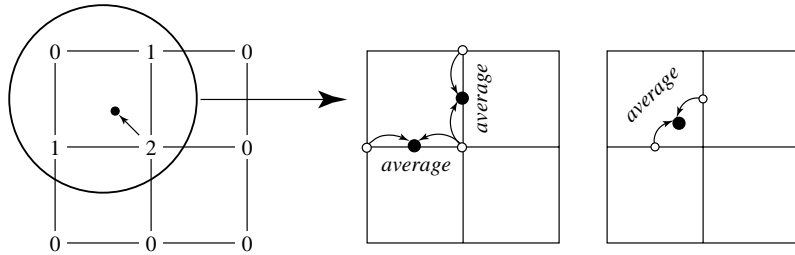

Figure 4.15: *The subdivision stencil for Midedge subdivision in the regular case (left). It can be understood as a sequence of averaging steps; at each step, two vertices are averaged.*

centroid averaging steps	scheme	smoothness in regular case
0	midpoint	C^0
1	Doo-Sabin	C^1
2	Catmull-Clark	C^2
3	Bi-Quartic	C^3
4

Biquartic subdivision scheme is a new dual scheme that is obtained by applying three centroid averaging steps after midpoint subdivision, as illustrated in Figure 4.16. As this scheme was not discussed before, we discuss it in greater detail here.

Generalized Biquartic Subdivision. The centroid averaging steps provide a nice theoretical way of deriving a new scheme, however, in practice we may want to use the complete masks directly (in particular, if we have to implement adaptive subdivision). Figure 4.16 shows the support of the stencil for Biquartic b-spline subdivision in the regular case (leftmost stencil).

Note that Biquartic subdivision can be implemented with very little additional work, compared to Doo-Sabin or Midedge. In an implementation of dual subdivision, vertices are organized as quadtrees. It is then natural to compute all four children of a given vertex at the same time. Considering the stencils for Doo-Sabin or the Midedge scheme we see that this implies access to all vertices of the faces incident to a given vertex. If these vertices have to be accessed we may as well use non-zero coefficients for all of them for each child to be computed. Qu [23] was the first to consider a generalization of the Biquartic B-splines to the arbitrary topology setting. He derived some conditions on the stencils but did not give a concrete set of coefficients. Repeated centroid averaging provides a simple way to derive the coefficients. It is possible to show that the resulting scheme is C^1 at extraordinary vertices. Assuming that only one of the incident faces for a vertex is extraordinary, we can write the subdivision masks for

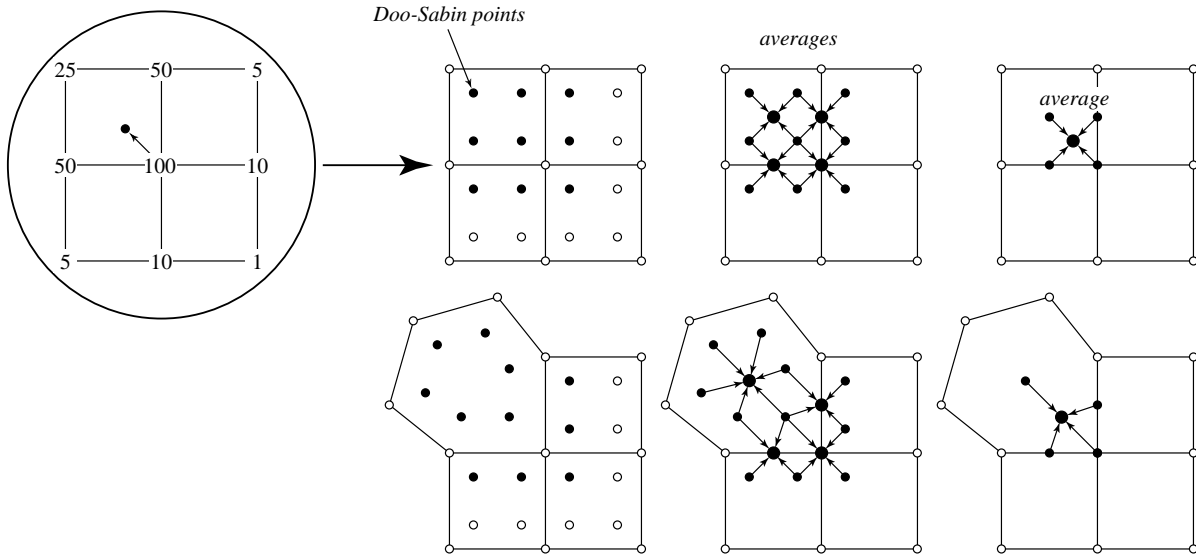

Figure 4.16: The subdivision stencil for bi-quartic b-splines (top row for the regular setting) can be written as a sequence of averaging steps. In a first step Doo-Sabin points are computed. These are subsequently averaged twice to arrive at the final point. This effects a factorization of the original mask (left) into a sequence of pure averaging steps. The same procedure is repeated using as an example a setting in which one incident face has valence $\neq 4$ (bottom row).

vertices near extraordinary faces in a more explicit form. There are three different masks for the four children (Figure 4.17). This is in contrast to the Doo-Sabin and Midedge schemes which have only one mask type for all children (modulo rotation). Vertices incident to the extraordinary faces contribute

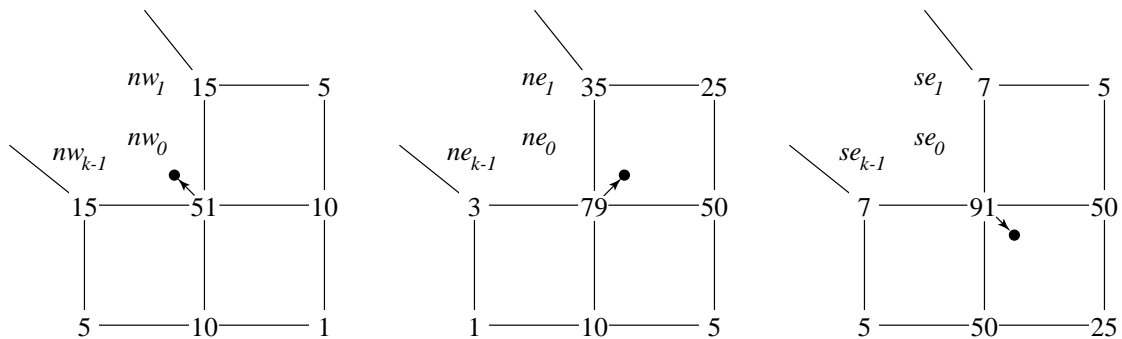

Figure 4.17: Generalized Biquartic compound masks for the north-west (nw), north-east (ne), and south-east (se) children of the center vertex. The south-west mask is the reflected (along the diagonal) version of the ne mask. All weights must be normalized by $1/256$ and the weights for the extraordinary vertices must be added. They are given in equation 4.5.

additional weights as

$$\begin{aligned}nw_i &= \frac{64}{k} + 48w_i + 16w_{i-1} + 16w_{i+1} \\ne_i &= 32w_i + 16w_{i-1} \\se_i &= 16w_i,\end{aligned}\tag{4.5}$$

where w_i are the Doo-Sabin weights, $i = 0, \dots, k-1$ and indices are taken modulo k .

4.8 Comparison of Schemes

In this section we compare different schemes by applying to a variety of meshes. First, we consider Loop, Catmull-Clark, Modified Butterfly and Doo-Sabin subdivision.

Figure 4.18 shows the surfaces obtained by subdividing a cube. Not surprisingly, Loop and Catmull-Clark subdivision produce more pleasing surfaces, as these schemes reduce to C^2 splines on a regular mesh. As all faces of the cube are quads, Catmull-Clark yields the nicest surface; the surface generated by the Loop scheme is more asymmetric, because the cube had to be triangulated before the scheme could be applied. At the same time, Doo-Sabin and Modified Butterfly reproduce the shape of the cube more closely. The surface quality is worst for the Modified Butterfly scheme, which interpolates the original mesh. We observe that there is a tradeoff between interpolation and surface quality: the closer the surface is to interpolating, the lower the surface quality.

Figure 4.19 shows the results of subdividing a tetrahedron. Similar observations hold in this case. In addition, we observe extreme shrinking for the Loop and Catmull-Clark subdivision schemes. This is a characteristic feature of approximating schemes: for small meshes, the resulting surface is likely to occupy much smaller volume than the original control mesh.

Finally, Figure 4.20 demonstrates that for sufficiently “smooth” meshes, with uniform triangle size and sufficiently small angles between adjacent faces, different schemes may produce virtually indistinguishable results. This fact might be misleading however, especially when interpolating schemes are used; interpolating schemes are very sensitive to the presence of sharp features and may produce low quality surfaces for many input meshes unless an initial mesh smoothing step is performed.

Overall, Loop and Catmull-Clark appear to be the best choices for most applications, which do not require exact interpolation of the initial mesh. The Catmull-Clark scheme is most appropriate for meshes with a significant fraction of quadrilateral faces. It might not perform well on certain types of meshes, most notably triangular meshes obtained by triangulation of a quadrilateral mesh (see Figure 4.21). The

Loop scheme performs reasonably well on any triangular mesh, thus, when triangulation is not objectionable, this scheme might be preferable. There are two main reasons why a quadrilateral scheme may be preferable: natural texture mapping for quads, and a natural number of symmetries (2). Indeed, many objects and characters have two easily identifiable special directions (“along the axis of the object” and “perpendicular to the axis”). The mesh representing the object can be aligned with these directions. Objects with three natural directions, that can be used to align a triangular mesh with the object, are much less common.

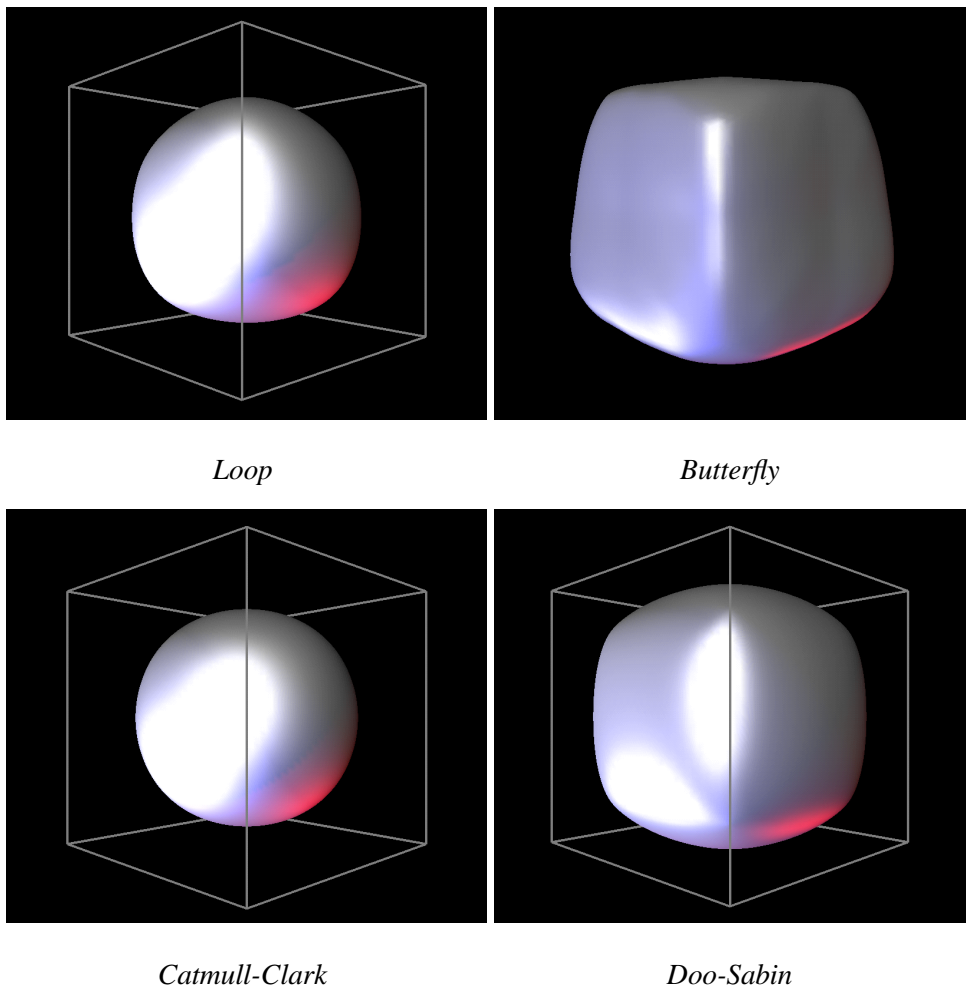

Figure 4.18: Results of applying various subdivision schemes to the cube. For triangular schemes (*Loop* and *Butterfly*) the cube was triangulated first.

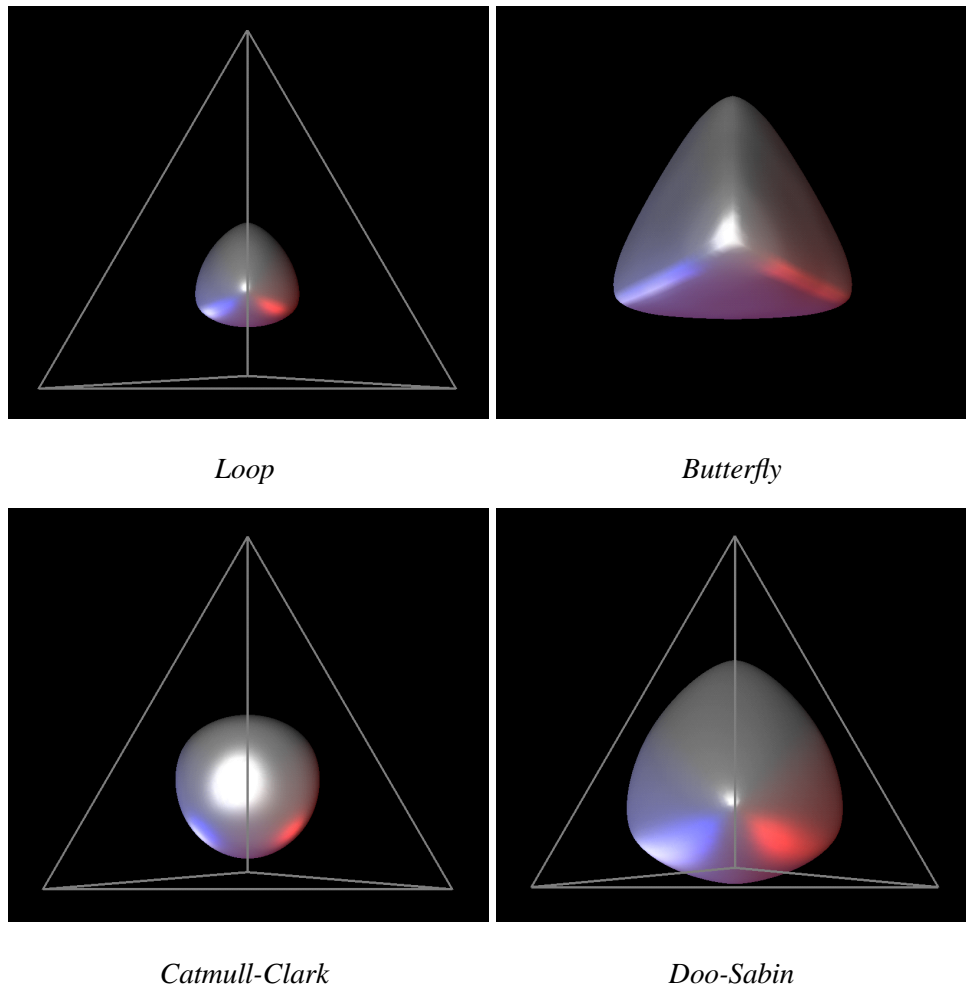
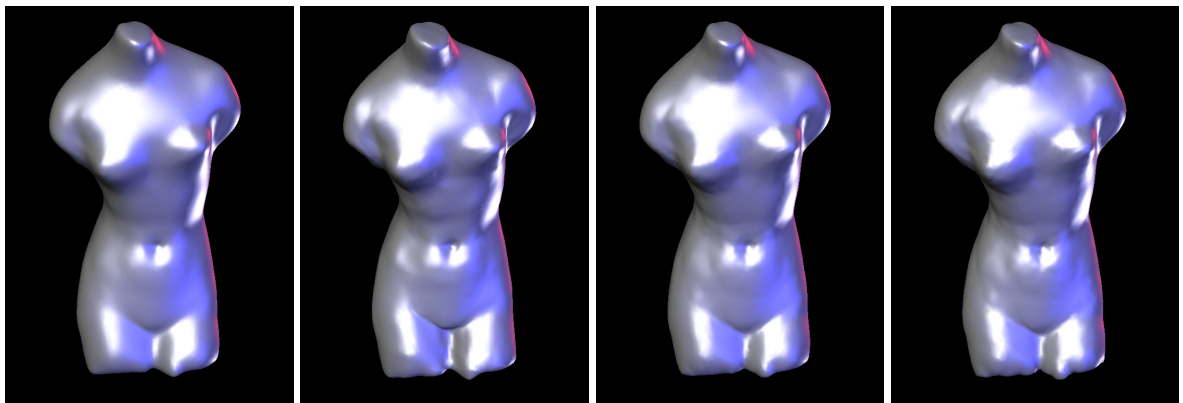

Figure 4.19: Results of applying various subdivision schemes to a tetrahedron.

4.8.1 Comparison of Dual Quadrilateral Schemes

Dual quadrilateral schemes are the only class of schemes with several members: Doo-Sabin, Midedge, Biquartic. In this section we give some numerical examples comparing the behavior of different dual quadrilateral subdivision schemes.

Much about a subdivision scheme is revealed by looking at the associated basis functions, i.e., the result of subdividing an initial control mesh which is planar except for a single vertex which is pulled out of the plane. Figure 4.22 shows such basis functions for Midedge, Doo-Sabin, and the Biquartic scheme in the vicinity of a k -gon for $k = 4$ and $k = 9$. Note how the smoothness increases with higher order. The



Loop

Butterfly

Catmull-Clark

Doo-Sabin

Figure 4.20: *Different subdivision schemes produce similar results for smooth meshes.*

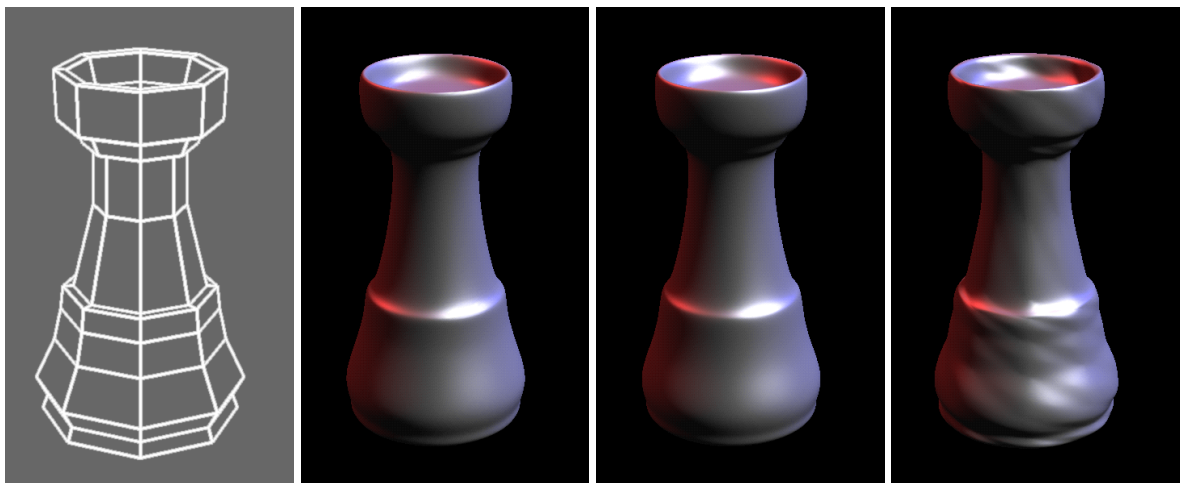

Initial mesh

Loop

Catmull-Clark

*Catmull-Clark, after
triangulation*

Figure 4.21: *Applying Loop and Catmull-Clark subdivision schemes to a model of a chess rook. The initial mesh is shown on the left. Before the Loop scheme was applied, the mesh was triangulated. Catmull-Clark was applied to the original quadrilateral model and to the triangulated model; note the substantial difference in surface quality.*

distinction is already apparent in the case $k = 4$, but becomes very noticeable for $k = 9$.

Figure 4.23 provides a similar comparison showing the effect of different dual quadrilateral subdivision schemes when the control polyhedron is a simple cube (compare to 4.18). Notice the increasing

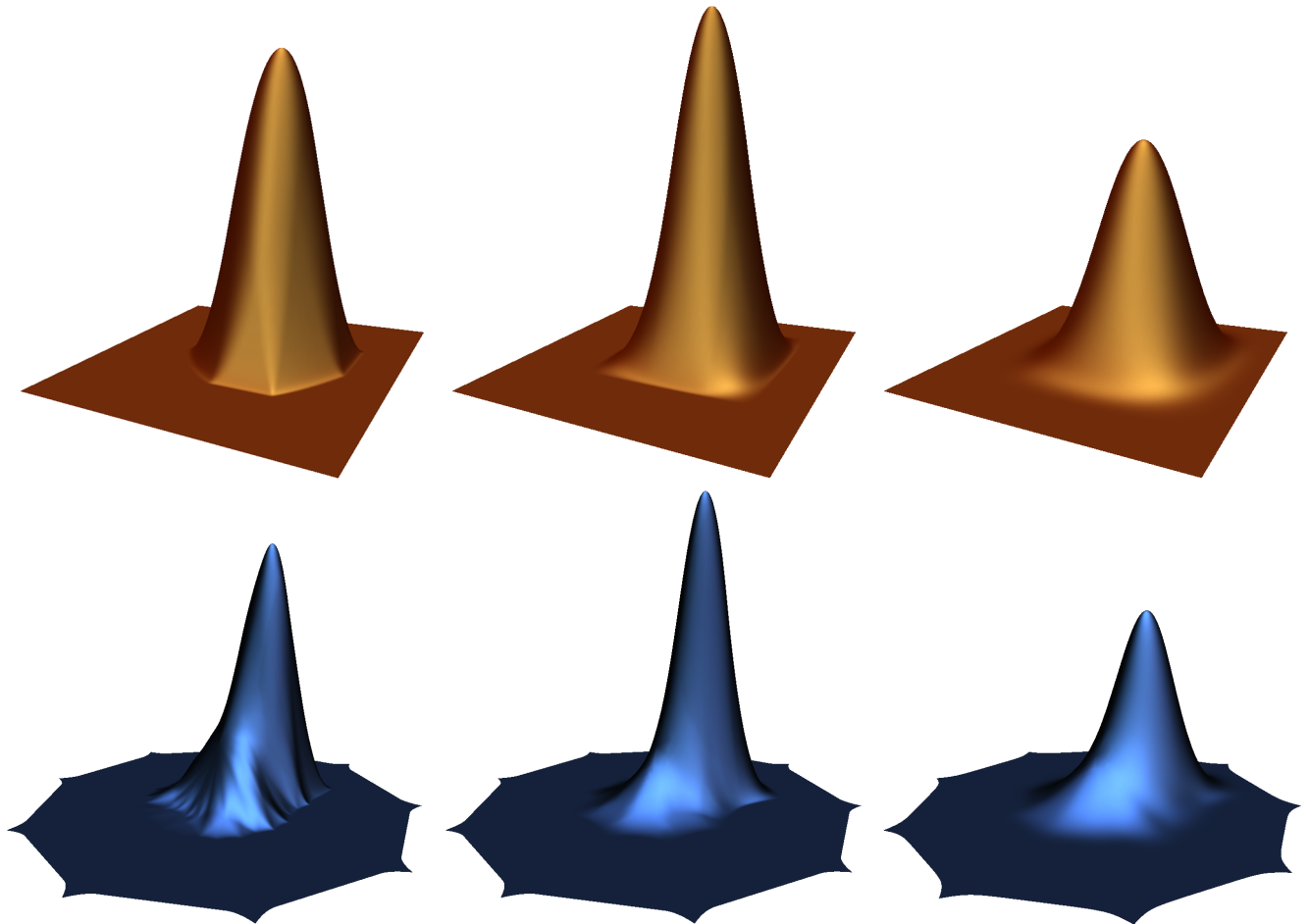

Figure 4.22: *Comparison of dual basis functions for a 4-gon (the regular case) on top and a 9-gon on the bottom. On the left the Midedge scheme (Warren/Habib variant), followed by the Doo-Sabin scheme and finally by the Biquartic generalization. The increasing smoothness is particularly noticeable in the 9-gon case.*

shrinkage with increasing smoothness. Since averages are convex combinations, the more averages are cascaded the more shrinkage can be expected.

Figure 4.24 shows a pipe shape with boundaries showing the effect of boundaries in the case of Midedge, Doo-Sabin and the Biquartic scheme.

Finally, Figure 4.25 shows the control mesh, limit surface and an adaptive tessellation blowup for a head shape.

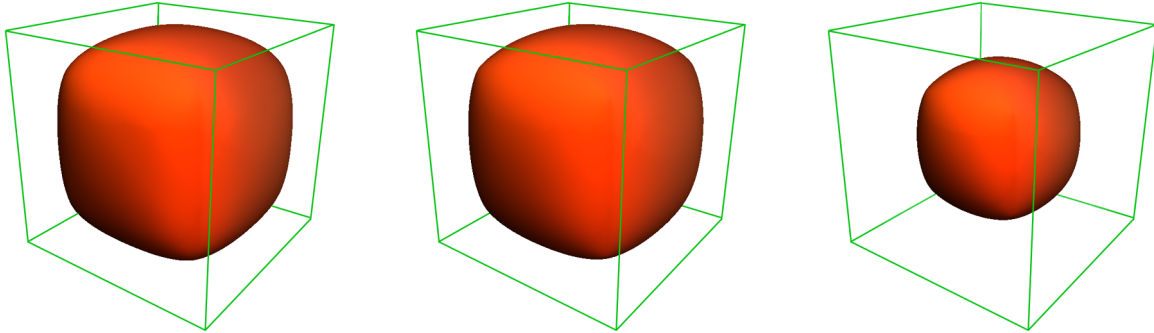

Figure 4.23: Comparison of dual subdivision schemes (Midedge, Doo-Sabin, Biquartic) for the case of a cube. The control polyhedron is shown in outline. Notice how Doo-Sabin and even more so the Biquartic scheme exhibit considerable shrinkage in this case, while the difference between Midedge and Doo-Sabin is only slight in this example.

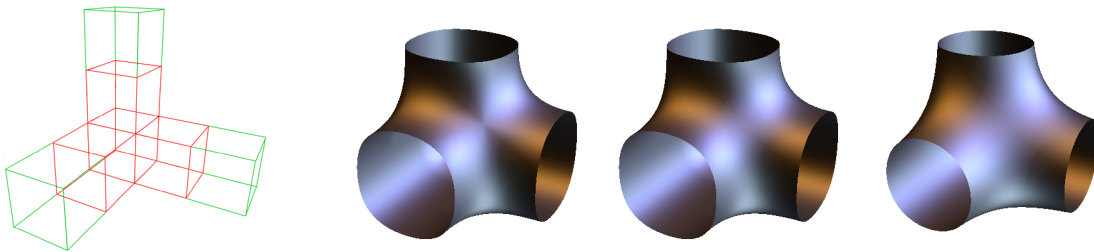

Figure 4.24: Control mesh for a three legged pipe (left). The red parts denote the control mesh for Midedge and Doo-Sabin, while the additional green section is necessary to have a complete set of boundary conditions for the bi-quartic scheme. The resulting surfaces in order: Midedge, Doo-Sabin, and Biquartic. Note the pinch point visible for Midedge and the increasing smoothness and roundness for Doo-Sabin and Biquartic.

4.9 Tilings

The classification that we have described in the beginning of the chapter, captures most known schemes. However, new schemes keep appearing, and some of the recent schemes do not fit well into this classification. It can be easily extended to handle a greater variety of schemes, if we include other refinement rules, in addition to vertex and face splits.

The starting point for refinement rules are the *isohedral tilings* and their dual tilings. A tiling is called isohedral, or Laves, if all tiles are identical, and for any vertex the angles between successive edges meeting at the vertex are equal.

In general, there are 11 tilings of the plane, shown in Figure 4.26; their dual tilings, obtained by con-

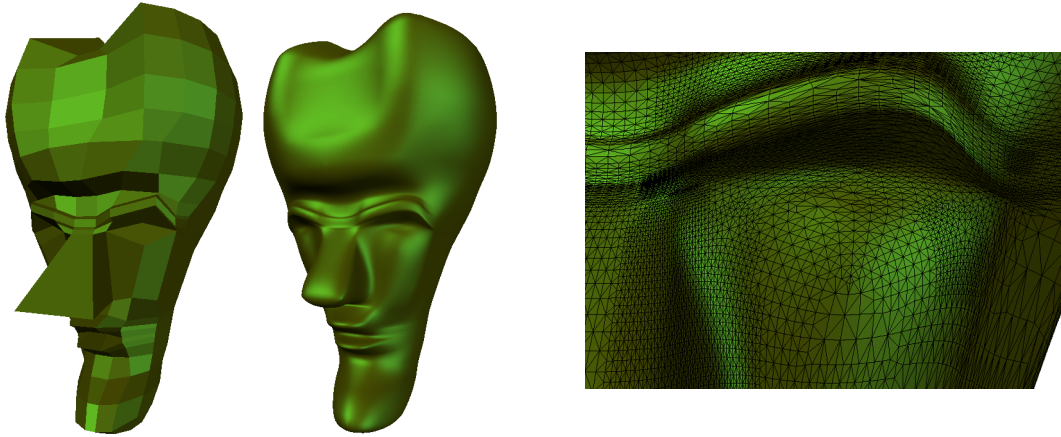

Figure 4.25: *An example of adaptive subdivision. On the left the control mesh, in the middle the smooth shaded limit surface and on the right a closeup of the adaptively triangulated limit surface.*

necting the centers of the tiles are called Archimedean tilings, and are shown in Figure 4.27. Archimedean tilings consist of regular polygons. We will refer to Laves and Archimedean tilings as regular tilings. Generalizing the idea of refinement rules to arbitrary regular tilings, we say that a refinement rule is an algorithm to obtain a finer regular tiling of the same type from a given regular tiling. This definition is quite general, and it is not known what all possible refinement rules are. The finer tiling is a scaled version of the initial tiling; the scaling factor can be arbitrary. For vertex and face splits, it is 2.

In practice, we are primarily interested in refinement rules that generalize well to arbitrary meshes. Face and vertex splits are examples of such rules. Three more exotic refinement rules have been considered: honeycomb refinement, $\sqrt{3}$ refinement and bisection.

Honeycomb refinement [8] shown in Figure 4.28, can be regarded as dual to the face split applied to the triangular mesh. While it is possible to design stationary schemes for honeycomb refinement, the scheme described in [8] is not stationary.

The $\sqrt{3}$ refinement [12], when applied to the regular triangulation of the plane (3^6 tiling), produces a tiling scaled by the factor $\sqrt{3}$ (Figure 4.29). The subdivision scheme described in [12] is stationary and produces C^2 subdivision surfaces on regular meshes.

Bisection, a well-known refinement technique often used for finite-element mesh refinement, can be used to refine $4 - k$ meshes [32, 31]. The refinement process for the regular 4.8^2 tiling is illustrated in Figure 4.30. Note that a single refinement step results in a new tiling scaled by $\sqrt{2}$. As shown in [30], Catmull-Clark and Doo-Sabin subdivision schemes, as well as some higher order schemes based on face

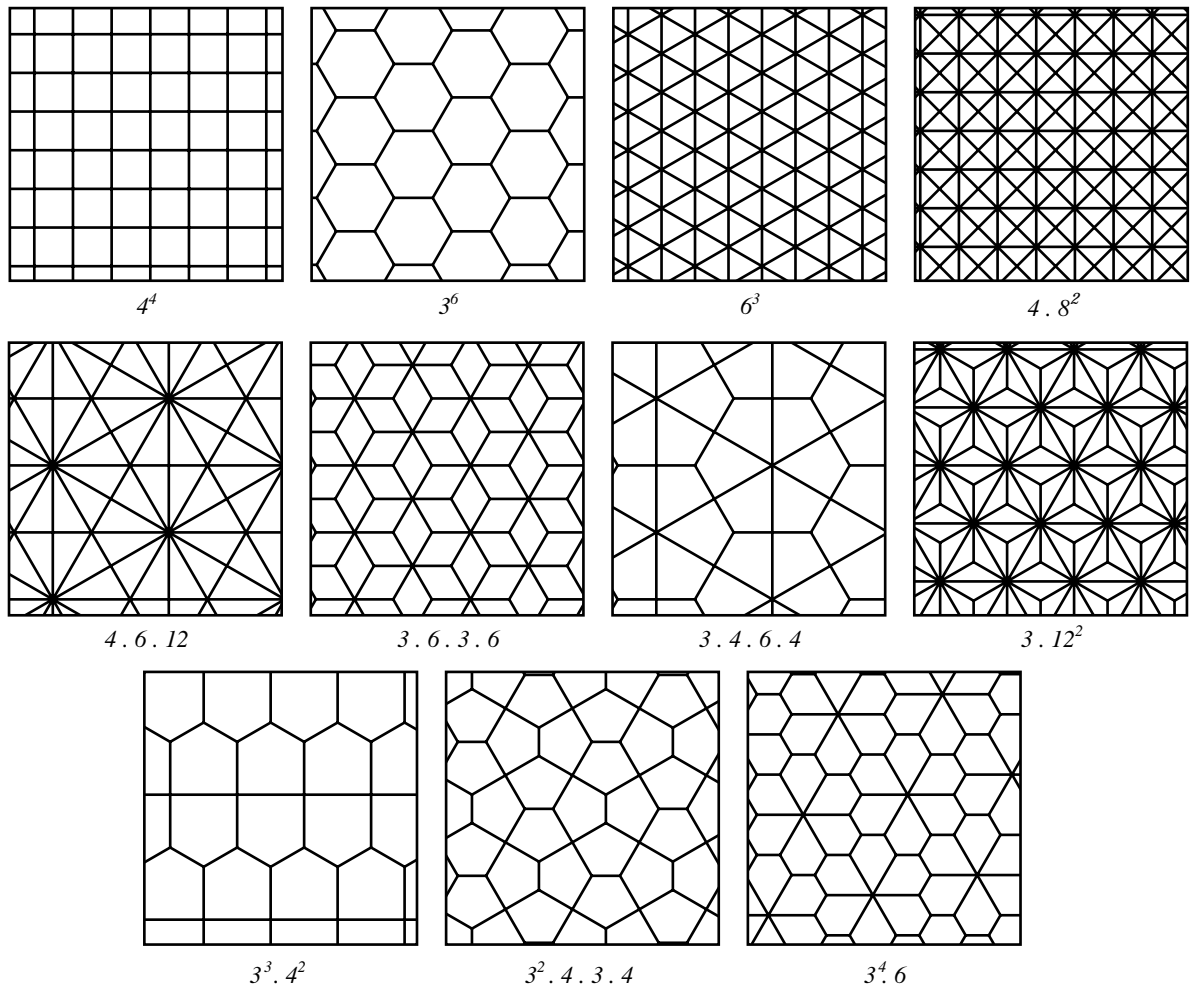

Figure 4.26: 11 Laves (isohedral) tilings.

or vertex splits, can be decomposed into sequences of bisection refinement steps. Both $\sqrt{3}$ and $4 - k$ subdivision have the advantage of approaching the limit surface more gradually. At each subdivision step, the number of triangles triples and doubles respectively, rather than quadruple, as is the case for face split refinement. This allows finer control of the approximation. In addition, adaptive subdivision can be easier to implement, if edge-based data structures are used to represent meshes (see also Chapter 5).

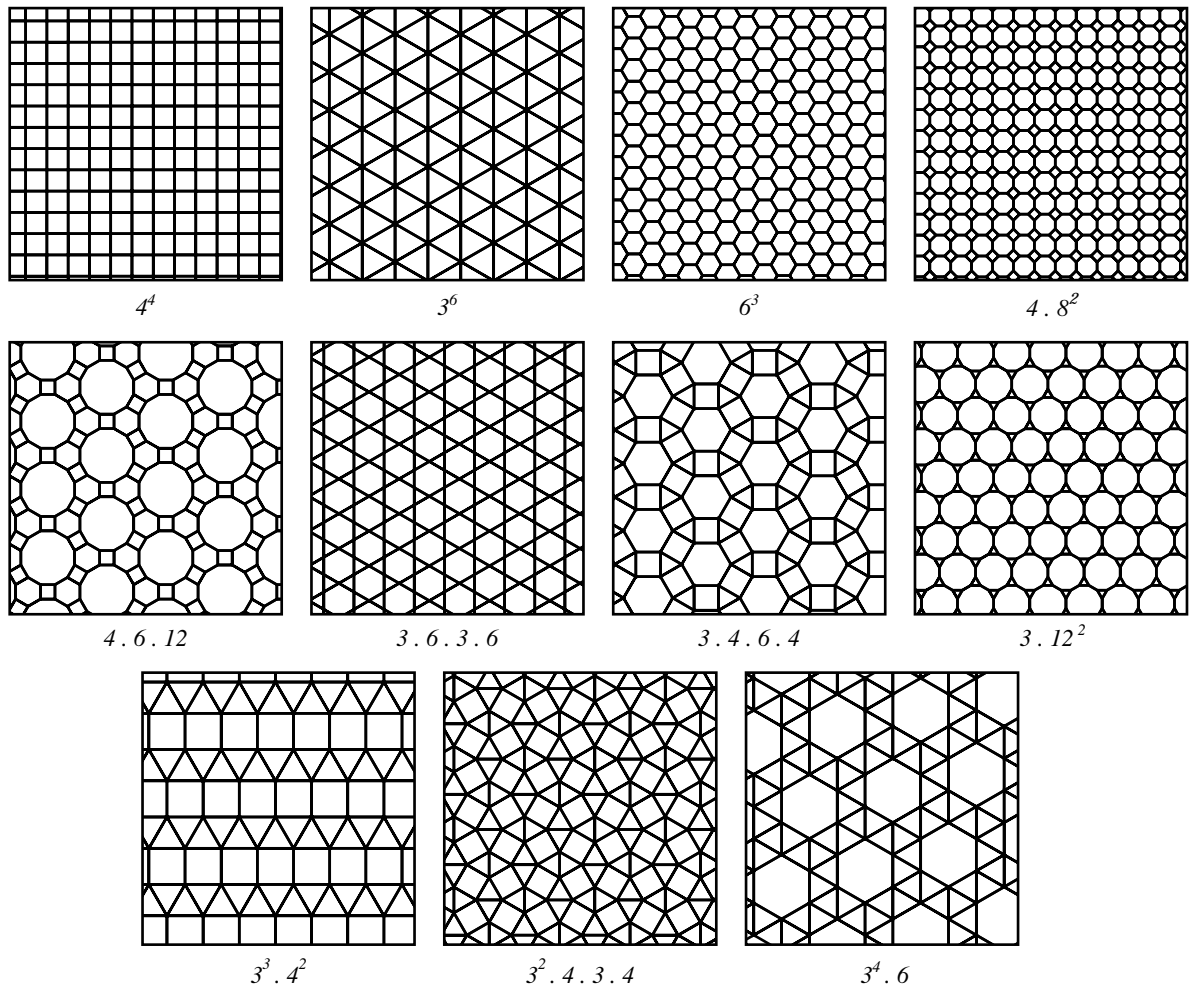

Figure 4.27: 11 Archimedean tilings, dual to Laves tilings.

4.10 Limitations of Stationary Subdivision

Stationary subdivision, while overcoming certain problems inherent in spline representations, still has a number of limitations. Most problems are much more apparent for interpolating schemes than for approximating schemes. In this section we briefly discuss a number of these problems.

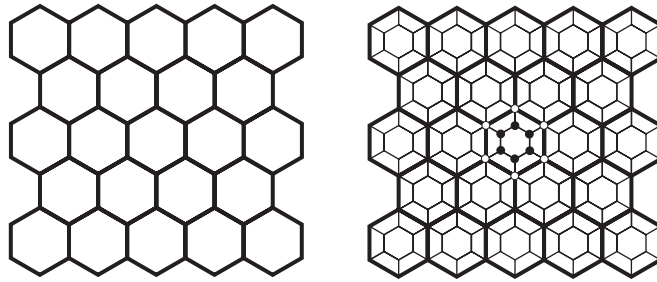

Figure 4.28: *Honeycomb refinement. Old vertices are preserved, and 6 new vertices are inserted for each face.*

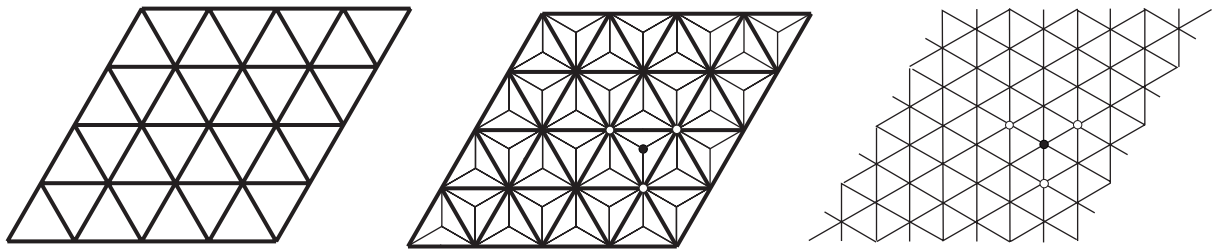

Figure 4.29: $\sqrt{3}$ refinement. *The barycenter is inserted into each triangle; this results in a 3.12^2 tiling. Then the edges are are flipped, to produce a new 3^6 tiling, which is scaled by $\sqrt{3}$ and rotated by 30 degrees with respect to the original.*

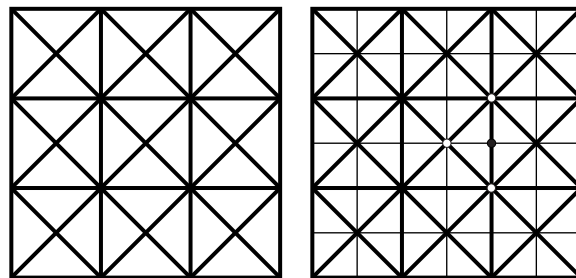

Figure 4.30: *Bisection on a 4-8 tiling: the hypotenuse of each triangle is split. The resulting tiling is a new 4-8 mesh, shrunk by $\sqrt{2}$ and rotated by 45 degrees.*

Problems with Curvature Continuity. While it is possible to obtain subdivision schemes which are C^2 -continuous, there are indications that such schemes either have very large support [24, 21], or necessarily have zero curvature at extraordinary vertices. A compromise solution was recently proposed by Umlauf [22]. Nevertheless, this limitation is quite fundamental: degeneracy or discontinuity of curvature

typically leads to visible defects of the surface.

Decrease of Smoothness with Valence. For some schemes, as the valence increases, the magnitude of the third largest eigenvalue approaches the magnitude of the subdominant eigenvalues. As an example we consider surfaces generated by the Loop scheme near vertices of high valence. In Figure 4.31 (right

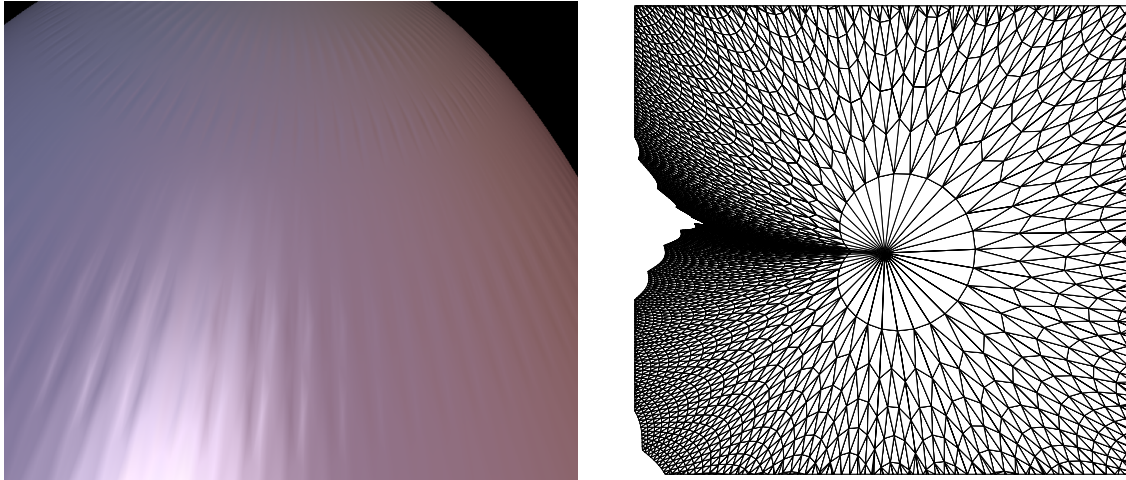

Figure 4.31: *Left: ripples on a surface generated by the Loop scheme near a vertex of large valence; Right: mesh structure for the Loop scheme near an extraordinary vertex with a significant “high-frequency” component; a crease starting at the extraordinary vertex appears.*

side), one can see a typical problem that occurs because of “eigenvalue clustering:” a crease might appear, abruptly terminating at the vertex. In some cases this behavior may be desirable, but our goal is to make it controllable rather than let the artifacts appear by chance.

Ripples. Another problem, presence of ripples in the surface close to an extraordinary point, is also shown in Figure 4.31. It is not clear whether this artifact can be eliminated. It is closely related to the curvature problem.

Uneven Structure of the Mesh. On regular meshes, subdivision matrices of C^1 -continuous schemes always have subdominant eigenvalue $1/2$. When the eigenvalues of subdivision matrices near extraordinary vertices significantly differ from $1/2$, the structure of the mesh becomes uneven: the ratio of the size of triangles on finer and coarser levels adjacent to a given vertex is roughly proportional to the magnitude of the subdominant eigenvalue. This effect can be seen clearly in Figure 4.33.

Optimization of Subdivision Rules. It is possible to eliminate eigenvalue clustering, as well as the difference in eigenvalues of the regular and extraordinary case by prescribing the eigenvalues of the subdivision matrix and deriving suitable subdivision coefficients. This approach was used to derive coefficients of the Butterfly scheme.

As expected, the meshes generated by the modified scheme have better structure near extraordinary points (Figure 4.32). However, the ripples become larger, so one kind of artifact is traded for another. It is, however, possible to seek an optimal solution or one close to optimal; alternatively, one may resort to a family of schemes that would provide for a controlled tradeoff between the two artifacts.

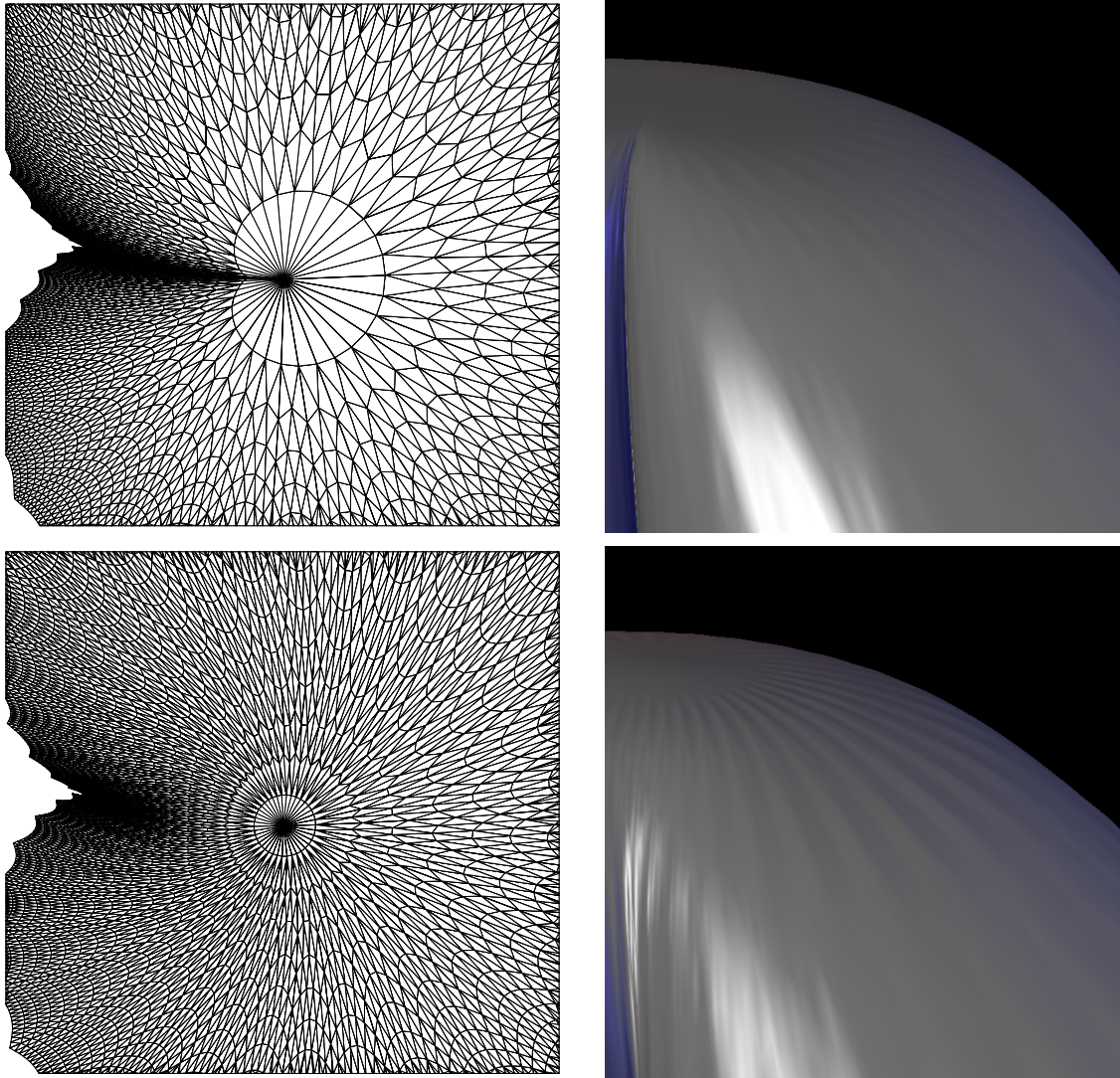

Figure 4.32: *Left: mesh structure for the Loop scheme and the modified Loop scheme near an extraordinary vertex; a crease does not appear for the modified Loop. Right: shaded images of the surfaces for Loop and modified Loop; ripples are more apparent for modified Loop.*

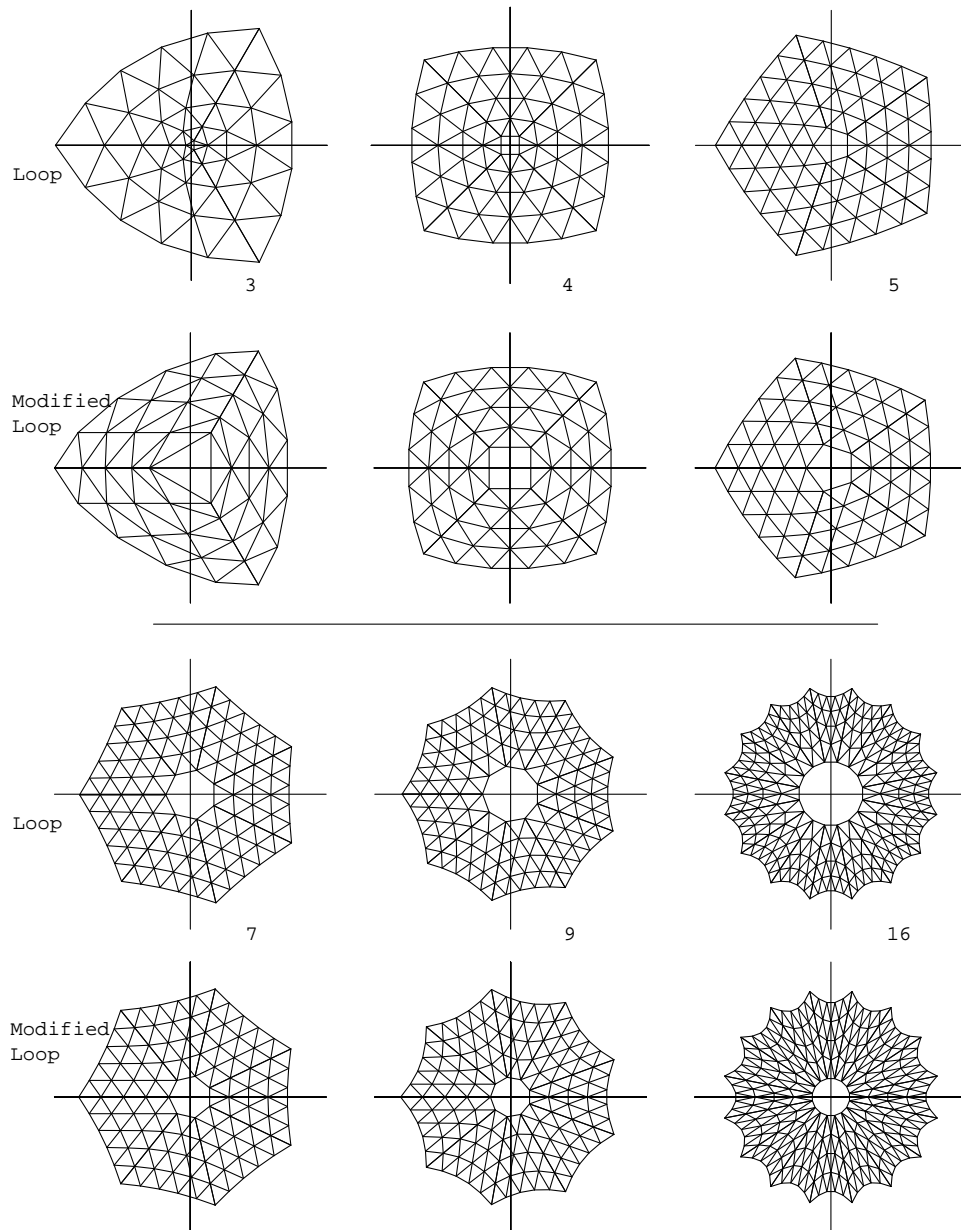

Figure 4.33: Comparison of control nets for the Loop and modified Loop scheme. Note that for the Loop scheme the size of the hole in the ring (1-neighborhood removed) is very small relative to the surrounding triangles for valence 3 and becomes larger as k grows. For the modified Loop scheme this size remains constant.

Bibliography

- [1] BALL, A. A., AND STORRY, D. J. T. Conditions for Tangent Plane Continuity over Recursively Generated B-Spline Surfaces. *ACM Trans. Gr.* 7, 2 (1988), 83–102.
- [2] BIERMANN, H., LEVIN, A., AND ZORIN, D. Piecewise smooth subdivision surfaces with normal control. Tech. Rep. TR1999-781, NYU, 1999.
- [3] BIERMANN, H., LEVIN, A., AND ZORIN, D. Piecewise smooth subdivision surfaces with normal control. In *SIGGRAPH 2000 Conference Proceedings*, Annual Conference Series, July 2000.
- [4] CATMULL, E., AND CLARK, J. Recursively Generated B-Spline Surfaces on Arbitrary Topological Meshes. *Computer Aided Design* 10, 6 (1978), 350–355.
- [5] DOO, D., AND SABIN, M. Analysis of the Behaviour of Recursive Division Surfaces near Extraordinary Points. *Computer Aided Design* 10, 6 (1978), 356–360.
- [6] DYN, N., GREGORY, J. A., AND LEVIN, D. A Four-Point Interpolatory Subdivision Scheme for Curve Design. *Comput. Aided Geom. Des.* 4 (1987), 257–268.
- [7] DYN, N., LEVIN, D., AND GREGORY, J. A. A Butterfly Subdivision Scheme for Surface Interpolation with Tension Control. *ACM Trans. Gr.* 9, 2 (April 1990), 160–169.
- [8] DYN, N., LEVIN, D., AND LIU, D. Interpolatory convexity-preserving subdivision for curves and surfaces. *Computer-Aided Design* 24, 4 (1992), 211–216.
- [9] HABIB, A., AND WARREN, J. Edge and Vertex Insertion for a Class of C^1 Subdivision Surfaces. presented at 4th SIAM Conference on Geometric Design, November 1995.

- [10] HOPPE, H., DEROSE, T., DUCHAMP, T., HALSTEAD, M., JIN, H., McDONALD, J., SCHWEITZER, J., AND STUETZLE, W. Piecewise Smooth Surface Reconsruction. In *Computer Graphics Proceedings*, Annual Conference Series, 295–302, 1994.
- [11] KOBBELT, L. Interpolatory Subdivision on Open Quadrilateral Nets with Arbitrary Topology. In *Proceedings of Eurographics 96*, Computer Graphics Forum, 409–420, 1996.
- [12] KOBBELT, L. $\sqrt{3}$ Subdivision. *Computer Graphics Proceedings*, Annual Conference Series, 2000.
- [13] LEVIN, A. Boundary algorithms for subdivision surfaces. In *Israel-Korea Bi-National Conference on New Themes in Computerized Geometrical Modeling*, 117–121, 1998.
- [14] LEVIN, A. Combined subdivision schemes for the design of surfaces satisfying boundary conditions. To appear in CAGD, 1999.
- [15] LEVIN, A. Interpolating nets of curves by smooth subdivision surfaces. to appear in SIGGRAPH'99 proceedings, 1999.
- [16] LOOP, C. Smooth Subdivision Surfaces Based on Triangles. Master's thesis, University of Utah, Department of Mathematics, 1987.
- [17] NASRI, A. H. Polyhedral Subdivision Methods for Free-Form Surfaces. *ACM Trans. Gr.* 6, 1 (January 1987), 29–73.
- [18] PETERS, J., AND REIF, U. Analysis of generalized B-spline subdivision algorithms. *SIAM Journal of Numerical Analysis* (1997).
- [19] PETERS, J., AND REIF, U. The simplest subdivision scheme for smoothing polyhedra. *ACM Trans. Gr.* 16(4) (October 1997).
- [20] PRAUTZSCH, H. Analysis of C^k -subdivision surfaces at extraordinary points. Preprint. Presented at Oberwolfach, June, 1995, 1995.
- [21] PRAUTZSCH, H., AND REIF, U. Necessary Conditions for Subdivision Surfaces. 1996.
- [22] PRAUTZSCH, H., AND UMLAUF, G. A G^2 -Subdivision Algorithm. In *Geometric Modeling*, G. Farin, H. Bieri, G. Brunnet, and T. DeRose, Eds., vol. Computing Suppl. 13. Springer-Verlag, 1998, pp. 217–224.

- [23] QU, R. *Recursive Subdivision Algorithms for Curve and Surface Design*. PhD thesis, Brunel University, 1990.
- [24] REIF, U. A Degree Estimate for Polynomial Subdivision Surface of Higher Regularity. Tech. rep., Universität Stuttgart, Mathematisches Institut A, 1995. preprint.
- [25] REIF, U. Some New Results on Subdivision Algorithms for Meshes of Arbitrary Topology. In *Approximation Theory VIII*, C. K. Chui and L. Schumaker, Eds., vol. 2. World Scientific, Singapore, 1995, pp. 367–374.
- [26] REIF, U. A Unified Approach to Subdivision Algorithms Near Extraordinary Points. *Comput. Aided Geom. Des.* 12 (1995), 153–174.
- [27] SAMET, H. *The Design and Analysis of Spatial Data Structures*. Addison-Wesley, 1990.
- [28] SCHWEITZER, J. E. *Analysis and Application of Subdivision Surfaces*. PhD thesis, University of Washington, Seattle, 1996.
- [29] STAM, J. On Subdivision Schemes Generalizing Uniform B-Spline Surfaces of Arbitrary Degree. Submitted for Publication, 2000.
- [30] VELHO, L., AND GOMES, J. Decomposing Quadrilateral Subdivision Rules into Binary 4–8 Refinement Steps. <http://www.impa.br/~lvelho/h4k/>, 1999.
- [31] VELHO, L., AND GOMES, J. Quasi 4-8 Subdivision Surfaces. In *XII Brazilian Symposium on Computer Graphics and Image Processing*, 1999.
- [32] VELHO, L., AND GOMES, J. Semi-Regular 4-8 Refinement and Box Spline Surfaces. Unpublished., 2000.
- [33] WARREN, J. Subdivision Methods for Geometric Design. Unpublished manuscript, November 1995.
- [34] WARREN, J., AND WEIMER, H. Subdivision for Geometric Design. 2000.
- [35] ZORIN, D. *Subdivision and Multiresolution Surface Representations*. PhD thesis, Caltech, Pasadena, 1997.
- [36] ZORIN, D. A method for analysis of C^1 -continuity of subdivision surfaces. *SIAM Journal of Numerical Analysis* 37, 4 (2000).

- [37] ZORIN, D. Smoothness of subdivision on irregular meshes. *Constructive Approximation* 16, 3 (2000).
- [38] ZORIN, D. Smoothness of subdivision surfaces on the boundary. preprint, Computer Science Department, New York University, 2000.
- [39] ZORIN, D., SCHRÖDER, P., AND SWELDENS, W. Interpolating Subdivision for Meshes with Arbitrary Topology. *Computer Graphics Proceedings (SIGGRAPH 96)* (1996), 189–192.
- [40] ZORIN, D., SCHRÖDER, P., AND SWELDENS, W. Interactive Multiresolution Mesh Editing. *Computer Graphics Proceedings, Annual Conference Series*, 1997.

Chapter 5

Implementing Subdivision and Multiresolution Surfaces

Denis Zorin, New York University
Peter Schröder, Caltech

5.1 Data Structures for Subdivision

In this section we briefly describe some considerations that we found useful when choosing appropriate data structures for implementing subdivision surfaces. We will consider both primal and dual subdivision schemes, as well as triangle and quadrilateral based schemes.

5.1.1 Representing Arbitrary Meshes

In all cases, we need to start with data structures representing the top-level mesh. For subdivision schemes we typically assume that the top level mesh satisfies several requirements that allow us to apply the subdivision rules everywhere. These requirements are

- no more than two polygons share an edge;
- all polygons sharing a vertex form an open or closed neighborhood of the vertex; in other words, can be arranged in such an order that two sequential polygons always share an edge.

A variety of representations were proposed in the past for general meshes of this type, sometimes with some of the assumptions relaxed, sometimes with more assumptions added, such as orientability of the

surface represented by the mesh. These representations include winged edge, quad edge, half edge and other data structures. The most common one is the winged edge. However, this data structure is far from being the most space efficient and convenient for subdivision. First, most data that we need to store in a mesh, is naturally associated with vertices and polygons, not edges. Edge-based data structures are more appropriate in the context of edge-collapse-based simplification. For subdivision, it is more natural to consider data structures with explicit representations for faces and vertices, not for edges. One possible and relatively simple data structure for polygons is

```
struct Polygon{
    vector<Vertex*>    vertices;
    vector<Polygon*>  neighbors;
    vector<short>     neighborEdges;
    ...
}
```

For each polygon, we store an array of pointers to vertices and an array of adjacent polygons (neighbors) across corresponding edge numbers. We also need to know for each edge what the corresponding edge number of that edge is, when seen from the neighbor across that edge. This information is stored in the array `neighborEdges` (see Figure 5.1). In addition, if we allow non-orientable surfaces, we need to

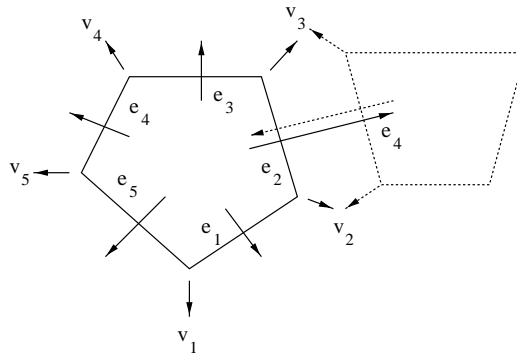

Figure 5.1: A polygon is described by an array of vertex pointers and an array of neighbor pointers (one such neighbor is indicated in dotted outline). Note that the neighbor has its own edge number assignment which may differ across the shared edge.

keep track of the orientation of the neighbors, which can be achieved by using signed edge numbers in the array `neighborEdges`. To complete the mesh representation, we add a data structure for vertices to the polygon data structure.

Let us compare this data structure to the winged edge. Let P be the number of polygons in the mesh, V the number of vertices and E the number of edges. The storage required for the polygon-based data structure is approximately $2.5 \cdot P \cdot V_P$ 32-bit words, where V_P is the average number of vertices per polygon. Here we assume that all polygons have fewer than 2^{16} edges, so only 2 bytes are required to store the edge number. Note that we disregard the geometric and other information stored in vertices and polygons, counting only the memory used to maintain the data structure.

To estimate the value of $2.5 \cdot P \cdot V_P$ in terms of V , we use the Euler formula. Recall that any mesh satisfies $V - E + P = g$, where g is the genus, the number of “holes” in the surface. Assuming genus small compared to the number of vertices, we get an approximate equation $V - E + P = 0$; we also assume that the boundary vertices are a negligible fraction of the total number of vertices. Each polygon on the average has V_P vertices and the same number of edges. Each edge is shared by two polygons which results in $E = V_P \cdot P/2$. Let P_V be the number of polygons per vertex. Then $P = P_V \cdot V/V_P$, and $E = V P_V/2$. This leads to

$$\frac{1}{P_V} + \frac{1}{V_P} = \frac{1}{2}. \quad (5.1)$$

In addition, we know that V_P , the average number of vertices per polygon, is at least 3. It follows from (5.1) that $P_V \leq 6$. Therefore, the total memory spent in the polygon data structure is $2.5P_V \cdot V \leq 15V$.

The winged edge data structure requires 8 pointers per edge. Four pointers to adjacent edges, two pointers to adjacent faces, and two pointers to vertices. Given that the total number of edges E is greater than $3V$, the total memory consumption is greater than $24V$, significantly worse than the polygon data structure.

One of the commonly mentioned advantages of the winged edge data structure is its constant size. It is unclear if this has any consequence in the context of C++: it is relatively easy to create structures with variable size. However, having a variety of dynamically allocated data of different small sizes may have a negative impact on performance. We observe that after the first subdivision step all polygons will be either triangles or quadrilaterals for all schemes that we have considered, so most of the data items will have fixed size and the memory allocation can be easily optimized.

5.1.2 Hierarchical Meshes: Arrays vs. Trees

Once a mesh is subdivided, we need to represent all the polygons generated by subdivision. The choice of representation depends on many factors. One of the important decisions to make is whether adaptive subdivision is necessary for a particular application or not. To understand this tradeoff we need to

estimate the storage associated with arrays vs. trees. To make this argument simple we will consider here only the case of triangle based subdivision such as Loop or Butterfly. The counting arguments for quadrilaterals schemes (both primal and dual) are essentially similar.

Assuming that only uniform subdivision is needed, all vertices and triangles associated with each subdivided top-level triangle can be represented as a two-dimensional array. Thus, the complete data structure would consist of a representation of a top level mesh, with each top level triangle containing a 2D array of vertex pointers. The pointers on the border between two top-level neighbors point pairwise to the same vertices. The advantage of this data structure is that it has practically no pointer overhead. The disadvantage is that a lot of space will be wasted if adaptive subdivision is performed.

If we do want adaptive subdivision and maintain efficient storage, the alternative is to use a tree structure. Each non-leaf triangle becomes a node in a quadtree, containing a pointer to a block of 4 children and pointers to three corner vertices

```
class TriangleQuadTree{
  Vertex*          v1, v2, v3;
  TriangleQuadTree* firstChild;
  ...
}
```

Comparison. To compare the two approaches to organizing the hierarchies (arrays and trees), we need to compare the representation overhead in these two cases. In the first case (arrays) all adjacency relations are implicit, and there is no overhead. In the second case, there is overhead in the form of pointers to children and vertices. For a given number of subdivision steps n the total overhead can be easily estimated. For the purposes of the estimate we can assume that the genus of our initial control mesh is 0, so the number of triangles P , the number of edges E and the number of vertices V in the initial mesh are related by $P - E + V = 0$. The total number of triangles in a complete tree of depth n for P initial triangles is given by $P(4^{n+1} - 1)/3$. For a triangle mesh $V_P = 3$ and $P_V = 6$ (see Eq. (5.1)); thus, the total number of triangles is $P = 2V$, and the total number of edges is $E = 3V$.

For each leaf and non-leaf node we need 4 words (1 pointer to the block of children and three pointers to vertices). The total cost of the structure is $4P(4^{n+1} - 1)/3 = 8V(4^{n+1} - 1)/3$ words, which is approximately $11 \cdot V \cdot 4^n$.

To estimate when a tree is spatially more efficient than an array, we determine how many nodes have to be removed from the tree for the gain from the adaptivity to exceed the loss from the overhead. For

this, we need a reasonable estimate of the size of the useful data stored in the structures, otherwise the array will always win.

The number of vertices inserted on subdivision step i is approximately $3 \cdot 4^{i-1}V$. Assuming that for each vertex we store all control points on all subdivision levels, and each control point takes 3 words, we get the following estimate for the control point storage

$$3V \left((n+1) + 3n + 3 \cdot 4^2(n-1) + \dots + 4^n \right) = V \left(4^{n+1} - 1 \right).$$

The total number of vertices is $V \cdot 4^n$; assuming that at each vertex we store the normal vector, the limit position vector (3 words), color (3 words) and some extra information, such as subdivision tags (1 word), we get $7 \cdot V \cdot 4^n$ more words. The total useful storage is approximately $11 \cdot V \cdot 4^n$, the same as the cost of the structure.

Thus for our example the tree introduces a 100% overhead, which implies that it has an advantage over the array if at least half of the nodes are absent. Whether this will happen, depends on the criterion for adaptation. If the criterion attempts to measure how well the surface approximates the geometry, and if only 3 or 4 subdivision levels are used, we have observed that fewer than 50% of the nodes were removed. However, if different criteria are used (e.g. distance to the camera) the situation is likely to be radically different. If more subdivision levels are used it is likely that almost all nodes on the finest level are absent.

5.1.3 Implementations

In many settings tree-based implementations, even with their additional overhead, are highly desirable. The case of quadtrees for primal triangle schemes is covered in [40] (this article is reprinted at the end of this chapter). The machinery for primal quadrilateral schemes (e.g., Catmull-Clark) is very similar. Here we look in some more detail at quadtrees for dual quadrilateral schemes. Since these are based on vertex splits the natural organization are quadtrees based on vertices *not* faces. As we will see the two trees are not that different and an actual implementation easily supports both primal and dual quadrilateral schemes. We begin with the dual quadrilateral case.

Representation

At the coarsest level the input control mesh is represented as a general mesh as described in Section 5.1.1. For simplicity we assume that the control mesh satisfies the property that all vertices have valence four. This can always be achieved through one step of dual subdivision. The valence four assumption allows

us to use quadtrees for the organization of vertices without an extra layer for the coarsest level. In fact we only have to organize a forest of quadtrees. Each quadtree root maintains four pointers to neighboring quadtrees roots

```
class QTreeR{
    QTreeR*  n[4];      // four neighbors
    QTree*   root;     // the actual tree
}
```

A quadtree is given as

```
class QTree{
    QTree*   p;        // parent
    QTree*   c[4];     // children
    Vector3D dual;     // dual control point
    Vector3D* primal[4]; // shared corners
}
```

The organization of these quadtrees is depicted in Figure 5.2. Both primal and dual subdivision can

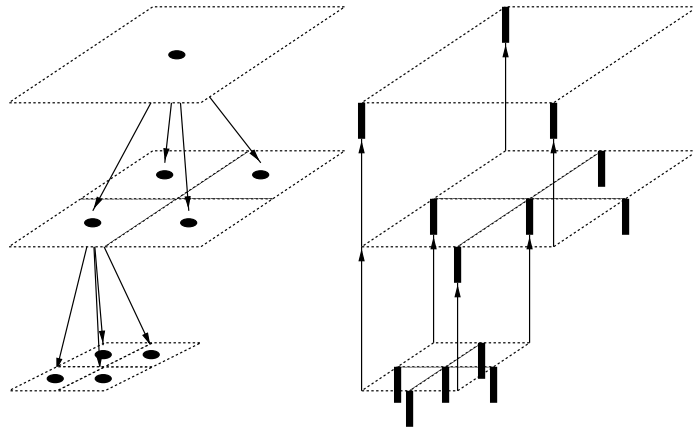

Figure 5.2: *Quadtrees carry dual control points (left). We may think of every quadtree element as describing a small rectangular piece of the limit surface centered at the associated control point (compare to Figure 5.3). The corners of those quads correspond to the location of primal control points (right) in a primal quadrilateral subdivision scheme. As usual these are shared among levels.*

now be effected by iterating over all faces and repeatedly averaging to achieve the desired order of subdivision [34, 30]. Alternatively one may apply subdivision rules in the more traditional setup by

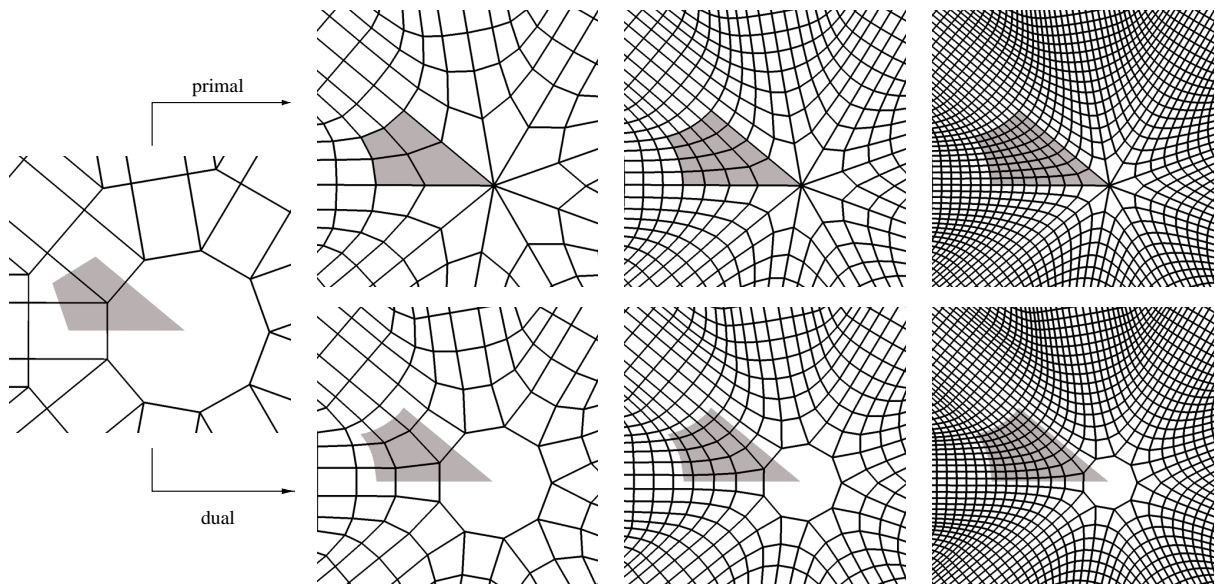

Figure 5.3: Given some arbitrary input mesh we may associate limit patches of dual schemes with vertices in the input mesh while primal schemes result in patches associated with faces. Here we see examples of the Catmull-Clark (top) and Doo-Sabin (bottom) acting on the same input mesh (left).

collecting the 1-ring of neighbors of a given control point (primal or dual). Collecting a 1-ring requires only the standard neighbor finding routines for quadtrees [27]. If the neighbor finding routine crosses from one quadtree to another the quadtree root links are used to effect this transition. Nil pointers indicate boundaries. With the 1-ring in hand one may apply stencils directly as indicated in Chapter 4. Using 1-rings and explicit subdivision masks, as opposed to repeated averaging, significantly simplifies boundary treatments and adaptivity.

Boundaries are typically dealt with in primal schemes using special boundary rules (see Chapter 4). For example, in the case of Catmull-Clark one can ensure that the outermost row of control vertices describes an endpoint interpolating cubic spline (see, e.g., [2]). For dual schemes, for example Doo-Sabin, a common solution is to replicate boundary control points (for other possibilities see the references in Chapter 4).

Constructing higher order quadrilateral subdivision schemes through repeated averaging will result in increasing shrinkage. This is true both for closed control meshes (see Figure 4.23) and for boundaries (see Figure 4.24). To address the boundary issue the repeated averaging steps may be modified there or one could simply drop the order of the method near the boundary. For example, in the case of the Biquartic scheme one may use the Doo-Sabin rules whenever a complete 1-ring is not available. This

leads to lower order near the boundary but avoids excessive shrinkage for high order methods. Which method is preferable depends heavily on the intended application.

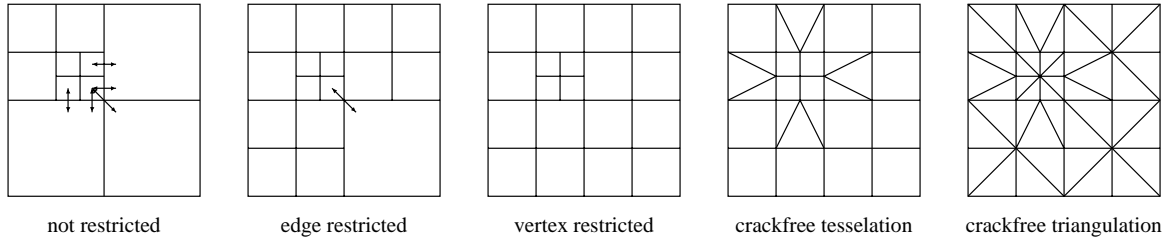

Figure 5.4: *On the left an unrestricted adaptive primal quadtree. Arrows indicate edge and vertex neighbors off by more than 1 level. Enforcing a standard edge restriction criterion enforces some additional subdivision. A vertex restriction criterion also disallows vertex neighbors off by more than 1 level. Finally on the right some adaptive tessellations which are crack-free.*

Adaptive Subdivision, as indicated earlier, can be valuable in some applications and may be mandatory in interactive settings to maintain high frame rates while escaping the exponential growth in the number of polygons with successive subdivisions. We first consider adaptive tessellations for primal quad schemes and then show how the same machinery applies to dual quad schemes.

To make such adaptive tessellations manageable it is common to enforce a restriction criterion on the quadtrees, i.e, no quadtree node is allowed to be off by more than one subdivision level from its neighbors. Typically this is applied only to *edge* neighbors, but we need a slightly stronger criterion covering *all* neighbors, i.e., including those sharing only a common vertex. This criterion is a consequence of the fact that to compute a control point at a finer level we need a complete subdivision stencil at a coarser level. for primal schemes, it means that if a face is subdivided, all faces sharing a vertex with it must be present. This idea is illustrated in Figure 5.4

Once a vertex restricted adaptive quadtree exists one must take care to output quadrilaterals or triangles in such a way that no cracks appear. Since all rendering is done with triangles we consider crack-free output of a triangulation only. This requires the insertion of diagonals in all quadrilaterals. One can make this choice randomly, but surfaces appear “nicer” if this is done in a regular fashion. Figure 5.5 illustrates this on the top for a group of four children of a common parent. Here the diagonals are chosen to meet at the center. The resulting triangulation is exactly the basic element of a 4-8 tiling [30]. To deal with cracks we distinguish 16 cases. Given a leaf quadrilateral its edge neighbors may be subdivided once less, as much, or once more. Only the latter case gives rise to potential cracks from the point of view of the leaf quad. The 16 cases are easily distinguished by considering a bit flag for each edge indicating whether the edge neighbor is subdivided once more or not. Figure 5.5 shows the resulting templates

Canonical case

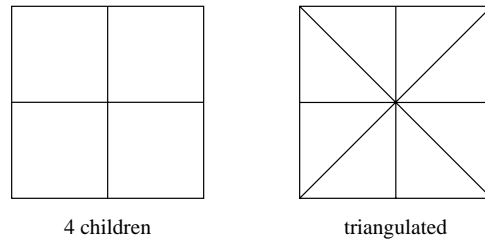

Templates for the adaptive case

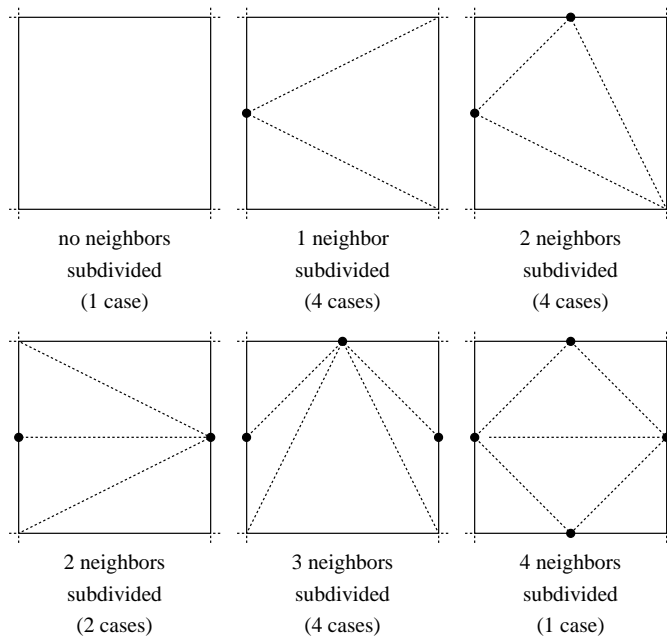

Figure 5.5: The top row shows the standard triangulation for a group of 4 child faces of a single face (face split subdivision). The 16 cases of adaptive triangulation of a leaf quadrilateral are shown below. Any one of the four edge neighbors may or may not be subdivided one level finer. Using the indicated templates one can triangulate an adaptive primal quad tree with a simple lookup table.

(modulo symmetries). These are easily implemented as a lookup table.

For dual quadrilateral subdivision schemes crack-free adaptive tessellations are harder to generate. Recall that in a dual quad scheme a quadtree node represents a control point, not a face. It potentially connects to all 8 neighbors (see Figure 5.6, left). Consequently there are 256 possible tessellations de-

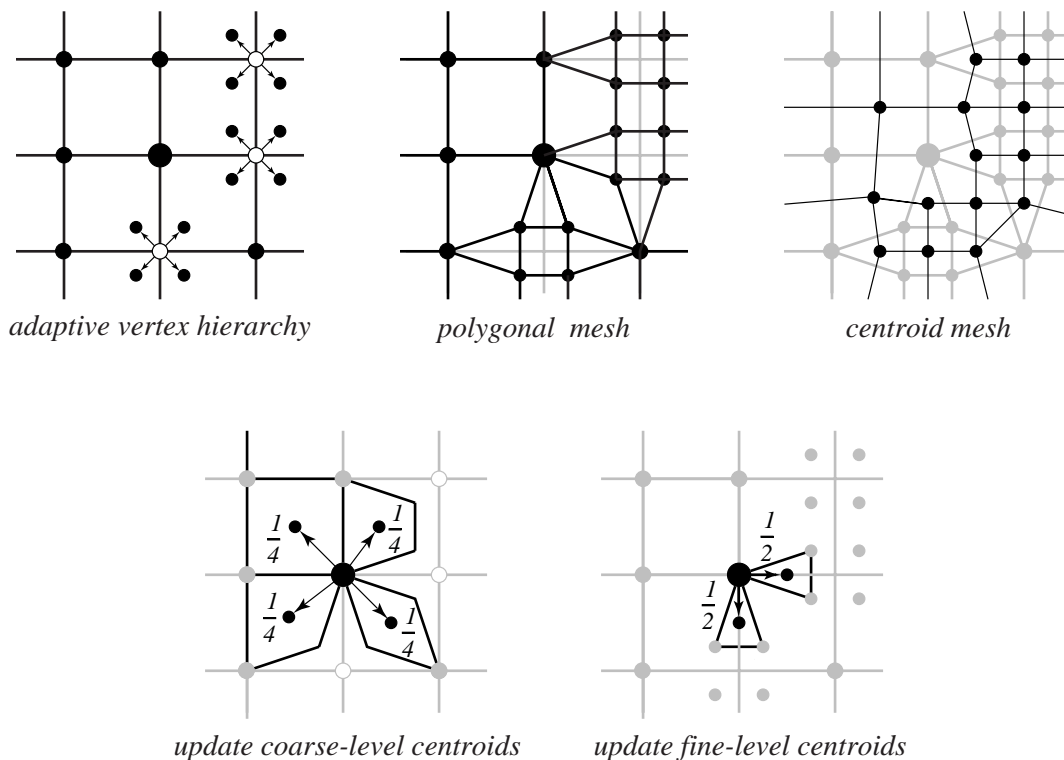

Figure 5.6: To produce a polygonal mesh for a restricted vertex-split hierarchy (top row, left), rather than trying to generate the mesh connecting the vertices (top row, middle) of the mesh, we generate the mesh connecting the centroids of the faces (top row, right). Centroids are associated with corners at subdivision levels. To compute centroids correctly, we traverse the vertices in the vertex hierarchy, and add contributions of the vertex to the centroids associated with the vertex (bottom row, left) and centroids associated with the corners attached to the children of a neighbor (bottom row, right). The choice of coefficients guarantees that centroids are found correctly.

pending on 8 neighbor states.

To avoid this explosion of cases we instead choose to draw (or output) a tessellation of the centroids of the dual control points. These live at corners again, so the adaptive tessellation machinery from the primal setting applies. This approach has the added benefit of producing samples of the limit surface for the Doo-Sabin and Midedge scheme. For the Biquartic scheme, unfortunately, limit points are not centroids of faces. Note that this additional averaging step is only performed during drawing or output and does not change the overall scheme. Figure 5.6 (right) shows how to form the additional averages in an adaptive setting. With these drawing averages computed we apply the templates of Figure 5.5 to

render the output mesh. Figure 4.25 shows an example of such an adaptively rendered mesh.

Interactive Multiresolution Mesh Editing

Denis Zorin*
Caltech

Peter Schröder†
Caltech

Wim Sweldens‡
Bell Laboratories

Abstract

We describe a multiresolution representation for meshes based on subdivision, which is a natural extension of the existing patch-based surface representations. Combining subdivision and the smoothing algorithms of Taubin [26] allows us to construct a set of algorithms for interactive multiresolution editing of complex hierarchical meshes of arbitrary topology. The simplicity of the underlying algorithms for refinement and coarsification enables us to make them local and adaptive, thereby considerably improving their efficiency. We have built a scalable interactive multiresolution editing system based on such algorithms.

1 Introduction

Applications such as special effects and animation require creation and manipulation of complex geometric models of arbitrary topology. Like real world geometry, these models often carry detail at many scales (cf. Fig. 1). The model might be constructed from scratch (ab initio design) in an interactive modeling environment or be scanned-in either by hand or with automatic digitizing methods. The latter is a common source of data particularly in the entertainment industry. When using laser range scanners, for example, individual models are often composed of high resolution meshes with hundreds of thousands to millions of triangles.

Manipulating such fine meshes can be difficult, especially when they are to be edited or animated. Interactivity, which is crucial in these cases, is challenging to achieve. Even without accounting for any computation on the mesh itself, available rendering resources alone, may not be able to cope with the sheer size of the data. Possible approaches include mesh optimization [15, 13] to reduce the size of the meshes.

Aside from considerations of economy, the choice of representation is also guided by the need for multiresolution editing semantics. The representation of the mesh needs to provide control at a large scale, so that one can change the mesh in a broad, smooth manner, for example. Additionally designers will typically also want control over the minute features of the model (cf. Fig. 1). Smoother approximations can be built through the use of patches [14], though at the cost of losing the high frequency details. Such detail can be reintroduced by combining patches with displacement maps [17]. However, this is difficult to manage in the

arbitrary topology setting and across a continuous range of scales and hardware resources.



Figure 1: Before the Armadillo started working out he was flabby, complete with a double chin. Now he exercises regularly. The original is on the right (courtesy Venkat Krishnamurthy). The edited version on the left illustrates large scale edits, such as his belly, and smaller scale edits such as his double chin; all edits were performed at about 5 frames per second on an Indigo R10000 Solid Impact.

For reasons of efficiency the algorithms should be highly adaptive and dynamically adjust to available resources. Our goal is to have a single, simple, uniform representation with scalable algorithms. The system should be capable of delivering multiple frames per second update rates even on small workstations taking advantage of lower resolution representations.

In this paper we present a system which possesses these properties

- **Multiresolution control:** Both broad and general handles, as well as small knobs to tweak minute detail are available.
- **Speed/fidelity tradeoff:** All algorithms dynamically adapt to available resources to maintain interactivity.
- **Simplicity/uniformity:** A single primitive, triangular mesh, is used to represent the surface across all levels of resolution.

Our system is inspired by a number of earlier approaches. We mention multiresolution editing [11, 9, 12], arbitrary topology subdivision [6, 2, 19, 7, 28, 16], wavelet representations [21, 24, 8, 3], and mesh simplification [13, 17]. Independently an approach similar to ours was developed by Pulli and Lounsbery [23].

It should be noted that our methods rely on the finest level mesh having subdivision connectivity. This requires a remeshing step before external high resolution geometry can be imported into the editor. Eck et al. [8] have described a possible approach to remeshing arbitrary finest level input meshes fully automatically. A method that relies on a user's expertise was developed by Krishnamurthy and Levoy [17].

1.1 Earlier Editing Approaches

H-splines were presented in pioneering work on hierarchical editing by Forsey and Bartels [11]. Briefly, H-splines are obtained by adding finer resolution B-splines onto an existing coarser resolution B-spline patch relative to the coordinate frame induced by the

*dzorin@gg.caltech.edu

†ps@cs.caltech.edu

‡wim@bell-labs.com

coarser patch. Repeating this process, one can build very complicated shapes which are entirely parameterized over the unit square. Forsey and Bartels observed that the hierarchy induced coordinate frame for the offsets is essential to achieve correct editing semantics.

H-splines provide a uniform framework for representing both the coarse and fine level details. Note however, that as more detail is added to such a model the internal control mesh data structures more and more resemble a fine polyhedral mesh.

While their original implementation allowed only for regular topologies their approach could be extended to the general setting by using surface splines or one of the spline derived general topology subdivision schemes [18]. However, these schemes have not yet been made to work adaptively.

Forsey and Bartels' original work focused on the ab initio design setting. There the user's help is enlisted in defining what is meant by different levels of resolution. The user decides where to add detail and manipulates the corresponding controls. This way the levels of the hierarchy are hand built by a human user and the representation of the final object is a function of its editing history.

To edit an a priori given model it is crucial to have a general procedure to define coarser levels and compute details between levels. We refer to this as the *analysis* algorithm. An H-spline analysis algorithm based on weighted least squares was introduced [10], but is too expensive to run interactively. Note that even in an ab initio design setting online analysis is needed, since after a long sequence of editing steps the H-spline is likely to be overly refined and needs to be consolidated.

Wavelets provide a framework in which to rigorously define multiresolution approximations and fast analysis algorithms. Finkelstein and Salesin [9], for example, used B-spline wavelets to describe multiresolution editing of curves. As in H-splines, parameterization of details with respect to a coordinate frame induced by the coarser level approximation is required to get correct editing semantics. Gortler and Cohen [12], pointed out that wavelet representations of detail tend to behave in undesirable ways during editing and returned to a pure B-spline representation as used in H-splines.

Carrying these constructions over into the arbitrary topology surface framework is not straightforward. In the work by Lounsbery et al. [21] the connection between wavelets and subdivision was used to define the different levels of resolution. The original constructions were limited to piecewise linear subdivision, but smoother constructions are possible [24, 28].

An approach to surface modeling based on variational methods was proposed by Welch and Witkin [27]. An attractive characteristic of their method is flexibility in the choice of control points. However, they use a global optimization procedure to compute the surface which is not suitable for interactive manipulation of complex surfaces.

Before we proceed to a more detailed discussion of editing we first discuss different surface representations to motivate our choice of synthesis (refinement) algorithm.

1.2 Surface Representations

There are many possible choices for surface representations. Among the most popular are polynomial patches and polygons.

Patches are a powerful primitive for the construction of coarse grain, smooth models using a small number of control parameters. Combined with hardware support relatively fast implementations are possible. However, when building complex models with many patches the preservation of smoothness across patch boundaries can be quite cumbersome and expensive. These difficulties are compounded in the arbitrary topology setting when polynomial parameterizations cease to exist everywhere. Surface splines [4, 20, 22] provide one way to address the arbitrary topology challenge.

As more fine level detail is needed the proliferation of control points and patches can quickly overwhelm both the user and the most powerful hardware. With detail at finer levels, patches become less suited and polygonal meshes are more appropriate.

Polygonal Meshes can represent arbitrary topology and resolve fine detail as found in laser scanned models, for example. Given that most hardware rendering ultimately resolves to triangle scan-conversion even for patches, polygonal meshes are a very basic primitive. Because of sheer size, polygonal meshes are difficult to manipulate interactively. Mesh simplification algorithms [13] provide one possible answer. However, we need a mesh simplification approach, that is hierarchical and gives us shape handles for smooth changes over larger regions while maintaining high frequency details.

Patches and fine polygonal meshes represent two ends of a spectrum. Patches efficiently describe large smooth sections of a surface but cannot model fine detail very well. Polygonal meshes are good at describing very fine detail accurately using dense meshes, but do not provide coarser manipulation semantics.

Subdivision connects and unifies these two extremes.

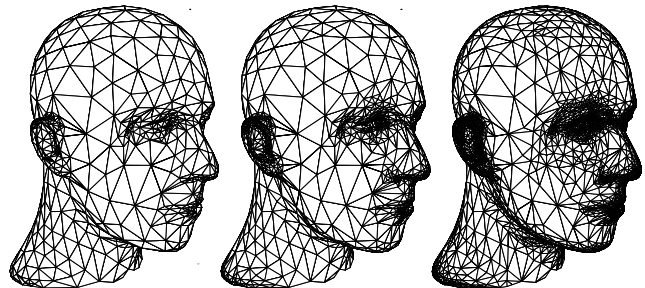

Figure 2: Subdivision describes a smooth surface as the limit of a sequence of refined polyhedra. The meshes show several levels of an adaptive Loop surface generated by our system (dataset courtesy Hugues Hoppe, University of Washington).

Subdivision defines a smooth surface as the limit of a sequence of successively refined polyhedral meshes (cf. Fig. 2). In the regular patch based setting, for example, this sequence can be defined through well known knot insertion algorithms [5]. Some subdivision methods generalize spline based knot insertion to irregular topology control meshes [2, 6, 19] while other subdivision schemes are independent of splines and include a number of interpolating schemes [7, 28, 16].

Since subdivision provides a path from patches to meshes, it can serve as a good foundation for the unified infrastructure that we seek. A single representation (hierarchical polyhedral meshes) supports the patch-type semantics of manipulation *and* finest level detail polyhedral edits equally well. The main challenge is to make the basic algorithms fast enough to escape the exponential time and space growth of naive subdivision. This is the core of our contribution.

We summarize the main features of subdivision important in our context

- **Topological Generality:** Vertices in a triangular (resp. quadrilateral) mesh need not have valence 6 (resp. 4). Generated surfaces are smooth everywhere, and efficient algorithms exist for computing normals and limit positions of points on the surface.
- **Multiresolution:** because they are the limit of successive refinement, subdivision surfaces support multiresolution algorithms, such as level-of-detail rendering, multiresolution editing, compression, wavelets, and numerical multigrid.

- **Simplicity:** subdivision algorithms are simple: the finer mesh is built through insertion of new vertices followed by *local* smoothing.
- **Uniformity of Representation:** subdivision provides a single representation of a surface at all resolution levels. Boundaries and features such as creases can be resolved through modified rules [14, 25], reducing the need for trim curves, for example.

1.3 Our Contribution

Aside from our perspective, which unifies the earlier approaches, our major contribution—and the main challenge in this program—is the design of highly adaptive and dynamic data structures and algorithms, which allow the system to function across a range of computational resources from PCs to workstations, delivering as much interactive fidelity as possible with a given polygon rendering performance. Our algorithms work for the class of 1-ring subdivision schemes (definition see below) and we demonstrate their performance for the concrete case of Loop’s subdivision scheme.

The particulars of those algorithms will be given later, but Fig. 3 already gives a preview of how the different algorithms make up the editing system. In the next sections we first talk in more detail about subdivision, smoothing, and multiresolution transforms.

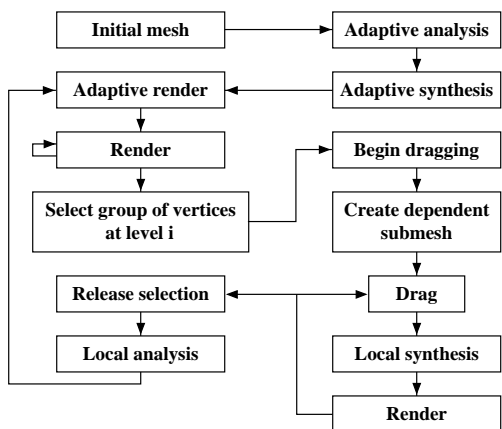

Figure 3: The relationship between various procedures as the user moves a set of vertices.

2 Subdivision

We begin by defining subdivision and fixing our notation. There are 2 points of view that we must distinguish. On the one hand we are dealing with an abstract *graph* and perform topological operations on it. On the other hand we have a *mesh* which is the geometric object in 3-space. The mesh is the image of a map defined on the graph: it associates a *point* in 3D with every *vertex* in the graph (cf. Fig. 4). A *triangle* denotes a face in the graph or the associated polygon in 3-space.

Initially we have a triangular graph T^0 with vertices V^0 . By recursively *refining* each triangle into 4 subtriangles we can build a sequence of finer triangulations T^i with vertices V^i , $i > 0$ (cf. Fig. 4). The superscript i indicates the *level* of triangles and vertices respectively. A triangle $t \in T^i$ is a triple of indices $t = \{v_a, v_b, v_c\} \subset V^i$.

The vertex sets are nested as $V^j \subset V^i$ if $j < i$. We define *odd* vertices on level i as $M^i = V^{i+1} \setminus V^i$. V^{i+1} consists of two disjoint sets: *even* vertices (V^i) and *odd* vertices (M^i). We define the *level* of a vertex v as the smallest i for which $v \in V^i$. The level of v is $i + 1$ if and only if $v \in M^i$.

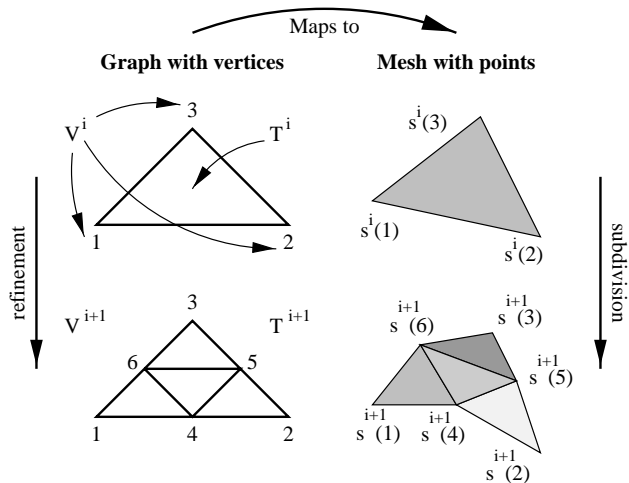

Figure 4: Left: the abstract graph. Vertices and triangles are members of sets V^i and T^i respectively. Their index indicates the level of refinement when they first appeared. Right: the mapping to the mesh and its subdivision in 3-space.

With each set V^i we associate a map, i.e., for each vertex v and each level i we have a 3D point $s^i(v) \in \mathbf{R}^3$. The set s^i contains all points on level i , $s^i = \{s^i(v) \mid v \in V^i\}$. Finally, a *subdivision scheme* is a linear operator S which takes the points from level i to points on the *finer* level $i + 1$: $s^{i+1} = S s^i$.

Assuming that the subdivision converges, we can define a limit surface σ as

$$\sigma = \lim_{k \rightarrow \infty} S^k s^0.$$

$\sigma(v) \in \mathbf{R}^3$ denotes the point on the limit surface associated with vertex v .

In order to define our offsets with respect to a local frame we also need tangent vectors and a normal. For the subdivision schemes that we use, such vectors can be defined through the application of linear operators Q and R acting on s^i so that $q^i(v) = (Qs^i)(v)$ and $r^i(v) = (Rs^i)(v)$ are linearly independent tangent vectors at $\sigma(v)$. Together with an orientation they define a local orthonormal frame $F^i(v) = (n^i(v), q^i(v), r^i(v))$. It is important to note that in general it is not necessary to use precise normals and tangents during editing; as long as the frame vectors are affinely related to the positions of vertices of the mesh, we can expect intuitive editing behavior.

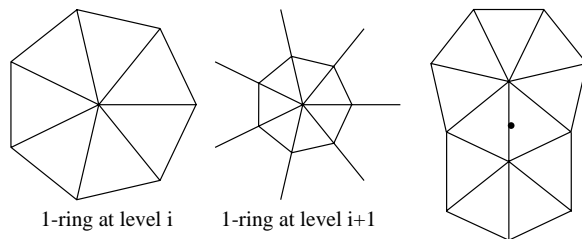

Figure 5: An even vertex has a 1-ring of neighbors at each level of refinement (left/middle). Odd vertices—in the middle of edges—have 1-rings around each of the vertices at either end of their edge (right).

Next we discuss two common subdivision schemes, both of which belong to the class of *1-ring schemes*. In these schemes points at level $i + 1$ depend only on 1-ring neighborhoods of points

at level i . Let $v \in V^i$ (v even) then the point $s^{i+1}(v)$ is a function of only those $s^i(v_n)$, $v_n \in V^i$, which are immediate neighbors of v (cf. Fig. 5 left/middle). If $m \in M^i$ (m odd), it is the vertex inserted when splitting an edge of the graph; we call such vertices *middle vertices* of edges. In this case the point $s^{i+1}(m)$ is a function of the 1-rings around the vertices at the ends of the edge (cf. Fig. 5 right).

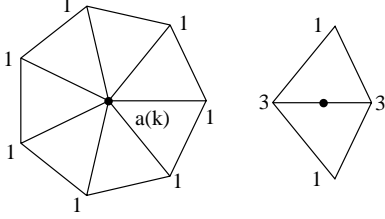

Figure 6: Stencils for Loop subdivision with unnormalized weights for even and odd vertices.

Loop is a non-interpolating subdivision scheme based on a generalization of quartic triangular box splines [19]. For a given even vertex $v \in V^i$, let $v_k \in V^i$ with $1 \leq k \leq K$ be its K 1-ring neighbors. The new point $s^{i+1}(v)$ is defined as $s^{i+1}(v) = (a(K) + K)^{-1}(a(K) s^i(v) + \sum_{k=1}^K s^i(v_k))$ (cf. Fig. 6), $a(K) = K(1 - \alpha(K))/\alpha(K)$, and $\alpha(K) = 5/8 - (3 + 2 \cos(2\pi/K))^2/64$. For odd v the weights shown in Fig. 6 are used. Two independent tangent vectors $t_1(v)$ and $t_2(v)$ are given by $t_p(v) = \sum_{k=1}^K \cos(2\pi(k+p)/K) s^i(v_k)$.

Features such as boundaries and cusps can be accommodated through simple modifications of the stencil weights [14, 25, 29].

Butterfly is an interpolating scheme, first proposed by Dyn et al. [7] in the topologically regular setting and recently generalized to arbitrary topologies [28]. Since it is interpolating we have $s^i(v) = \sigma(v)$ for $v \in V^i$ even. The exact expressions for odd vertices depend on the valence K and the reader is referred to the original paper for the exact values [28].

For our implementation we have chosen the Loop scheme, since more performance optimizations are possible in it. However, the algorithms we discuss later work for any 1-ring scheme.

3 Multiresolution Transforms

So far we only discussed subdivision, i.e., how to go from coarse to fine meshes. In this section we describe analysis which goes from fine to coarse.

We first need *smoothing*, i.e., a linear operation H to build a smooth coarse mesh at level $i - 1$ from a fine mesh at level i :

$$s^{i-1} = H s^i.$$

Several options are available here:

- **Least squares:** One could define analysis to be optimal in the least squares sense,

$$\min_{s^{i-1}} \|s^i - S s^{i-1}\|^2.$$

The solution may have unwanted undulations and is too expensive to compute interactively [10].

- **Fairing:** A coarse surface could be obtained as the solution to a global variational problem. This is too expensive as well. An alternative is presented by Taubin [26], who uses a *local* non-shrinking smoothing approach.

Because of its computational simplicity we decided to use a version of Taubin smoothing. As before let $v \in V^i$ have K neighbors $v_k \in V^i$. Use the average, $\bar{s}^i(v) = K^{-1} \sum_{k=1}^K s^i(v_k)$, to define the discrete Laplacian $\mathcal{L}(v) = \bar{s}^i(v) - s^i(v)$. On this basis Taubin gives a Gaussian-like smoother which does not exhibit shrinkage

$$H := (I + \mu \mathcal{L})(I + \lambda \mathcal{L}).$$

With subdivision and smoothing in place, we can describe the transform needed to support multiresolution editing. Recall that for multiresolution editing we want the difference between successive levels expressed with respect to a frame induced by the coarser level, i.e., the offsets are relative to the smoother level.

With each vertex v and each level $i > 0$ we associate a *detail vector*, $d^i(v) \in \mathbf{R}^3$. The set d^i contains all detail vectors on level i , $d^i = \{d^i(v) \mid v \in V^i\}$. As indicated in Fig. 7 the detail vectors are defined as

$$d^i = (F^i)^t (s^i - S s^{i-1}) = (F^i)^t (I - S H) s^i,$$

i.e., the detail vectors at level i record how much the points at level i differ from the result of subdividing the points at level $i - 1$. This difference is then represented with respect to the local frame F^i to obtain coordinate independence.

Since detail vectors are sampled on the fine level mesh V^i , this transformation yields an overrepresentation in the spirit of the Burt-Adelson Laplacian pyramid [1]. The only difference is that the smoothing filters (Taubin) are not the dual of the subdivision filter (Loop). Theoretically it would be possible to subsample the detail vectors and only record a detail per odd vertex of M^{i-1} . This is what happens in the wavelet transform. However, subsampling the details severely restricts the family of smoothing operators that can be used.

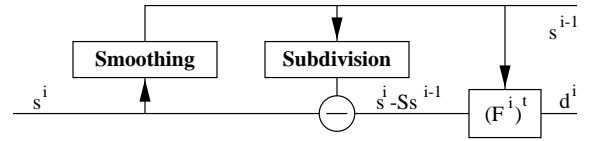

Figure 7: Wiring diagram of the multiresolution transform.

4 Algorithms and Implementation

Before we describe the algorithms in detail let us recall the overall structure of the mesh editor (cf. Fig 3). The analysis stage builds a succession of coarser approximations to the surface, each with fewer control parameters. Details or offsets between successive levels are also computed. In general, the coarser approximations are not visible; only their control points are rendered. These control points give rise to a *virtual surface* with respect to which the remaining details are given. Figure 8 shows wireframe representations of virtual surfaces corresponding to control points on levels 0, 1, and 2.

When an edit level is selected, the surface is represented internally as an approximation at this level, plus the set of all finer level details. The user can freely manipulate degrees of freedom at the edit level, while the finer level details remain unchanged relative to the coarser level. Meanwhile, the system will use the synthesis algorithm to render the modified edit level with all the finer details added in. In between edits, analysis enforces consistency on the internal representation of coarser levels and details (cf. Fig. 9).

The basic algorithms *Analysis* and *Synthesis* are very simple and we begin with their description.

Let $i = 0$ be the coarsest and $i = n$ the finest level with N vertices. For each vertex v and all levels i finer than the first level

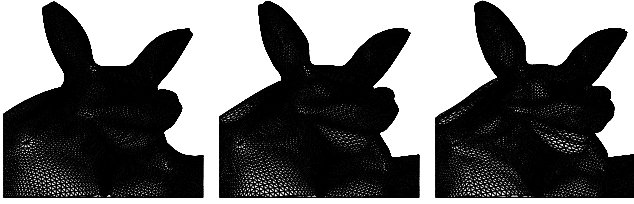

Figure 8: Wireframe renderings of virtual surfaces representing the first three levels of control points.

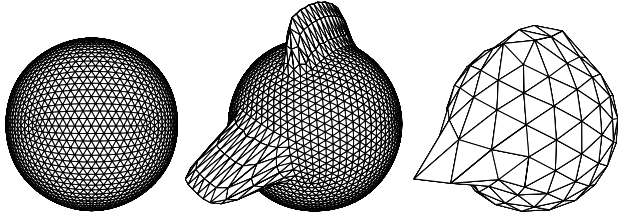

Figure 9: Analysis propagates the changes on finer levels to coarser levels, keeping the magnitude of details under control. Left: The initial mesh. Center: A simple edit on level 3. Right: The effect of the edit on level 2. A significant part of the change was absorbed by higher level details.

where the vertex v appears, there are storage locations $v.s[i]$ and $v.d[i]$, each with 3 floats. With this the total storage adds to $2 * 3 * (4N/3)$ floats. In general, $v.s[i]$ holds $s^i(v)$ and $v.d[i]$ holds $d^i(v)$; temporarily, these locations can be used to store other quantities. The local frame is computed by calling $v.F(i)$.

Global analysis and synthesis are performed level wise:

<pre>Analysis for i = n downto 1 Analysis(i)</pre>	<pre>Synthesis for i = 1 to n Synthesis(i)</pre>
--	--

With the action at each level described by

<pre>Analysis(i) forall v in V^{i-1} : v.s[i-1] := smooth(v, i) forall v in V^i : v.d[i] := v.F(i)^t * (v.s[i] - subd(v, i-1))</pre>
--

and

<pre>Synthesis(i) forall v in V^i : s.v[i] := v.F(i) * v.d[i] + subd(v, i-1)</pre>
--

Analysis computes points on the coarser level $i-1$ using smoothing (`smooth`), subdivides s^{i-1} (`subd`), and computes the detail vectors d^i (cf. Fig. 7). Synthesis reconstructs level i by subdividing level $i-1$ and adding the details.

So far we have assumed that all levels are uniformly refined, i.e., all neighbors at all levels exist. Since time and storage costs grow exponentially with the number of levels, this approach is unsuitable for an interactive implementation. In the next sections we explain how these basic algorithms can be made memory and time efficient.

Adaptive and *local* versions of these generic algorithms (cf. Fig. 3 for an overview of their use) are the key to these savings. The underlying idea is to use lazy evaluation and pruning based on

thresholds. Three thresholds control this pruning: ϵ_A for adaptive analysis, ϵ_S for adaptive synthesis, and ϵ_R for adaptive rendering. To make lazy evaluation fast enough several caches are maintained explicitly and the order of computations is carefully staged to avoid recomputation.

4.1 Adaptive Analysis

The generic version of analysis traverses entire levels of the hierarchy starting at some finest level. Recall that the purpose of analysis is to compute coarser approximations and detail offsets. In many regions of a mesh, for example, if it is flat, no significant details will be found. *Adaptive analysis* avoids the storage cost associated with detail vectors below some threshold ϵ_A by observing that small detail vectors imply that the finer level almost coincides with the subdivided coarser level. The storage savings are realized through *tree pruning*.

For this purpose we need an integer $v.finest := \max_i \{\|v.d[i]\| \geq \epsilon_A\}$. Initially $v.finest = n$ and the following precondition holds before calling `Analysis(i)`:

- The surface is uniformly subdivided to level i ,
- $\forall v \in V^i : v.s[i] = s^i(v)$,
- $\forall v \in V^i \mid i < j \leq v.finest : v.d[j] = d^j(v)$.

Now `Analysis(i)` becomes:

<pre>Analysis(i) forall v in V^{i-1} : v.s[i-1] := smooth(v, i) forall v in V^i : v.d[i] := v.s[i] - subd(v, i-1) if v.finest > i or \ v.d[i]\ >= \epsilon_A then v.d[i] := v.F(i)^t * v.d[i] else v.finest := i-1 Prune(i-1)</pre>
--

Triangles that do not contain details above the threshold are unrefined:

<pre>Prune(i) forall t in T^i : If all middle vertices m have m.finest = i-1 and all children are leaves, delete children.</pre>
--

This results in an adaptive mesh structure for the surface with $v.d[i] = d^i(v)$ for all $v \in V^i$, $i \leq v.finest$. Note that the resulting mesh is not restricted, i.e., two triangles that share a vertex can differ in more than one level. Initial analysis has to be followed by a synthesis pass which enforces restriction.

4.2 Adaptive Synthesis

The main purpose of the general synthesis algorithm is to rebuild the finest level of a mesh from its hierarchical representation. Just as in the case of analysis we can get savings from noticing that in flat regions, for example, little is gained from synthesis and one might as well save the time and storage associated with synthesis. This is the basic idea behind *adaptive synthesis*, which has two main purposes. First, ensure the mesh is restricted on each level, (cf. Fig. 10). Second, refine triangles and recompute points until the mesh has reached a certain measure of local flatness compared against the threshold ϵ_S .

The algorithm recomputes the points $s^i(v)$ starting from the coarsest level. Not all neighbors needed in the subdivision stencil of a given point necessarily exist. Consequently adaptive synthesis

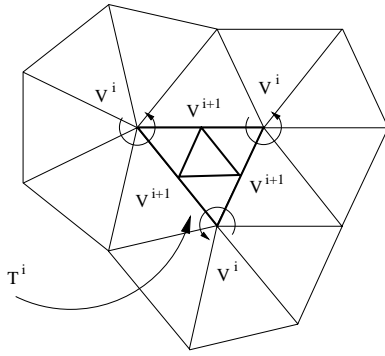

Figure 10: A restricted mesh: the center triangle is in T^i and its vertices in V^i . To subdivide it we need the 1-rings indicated by the circular arrows. If these are present the graph is restricted and we can compute s^{i+1} for all vertices and middle vertices of the center triangle.

lazily creates all triangles needed for subdivision by temporarily refining their parents, then computes subdivision, and finally deletes the newly created triangles unless they are needed to satisfy the restriction criterion. The following precondition holds before entering AdaptiveSynthesis:

- $\forall t \in T^j \mid 0 \leq j \leq i : t$ is restricted
- $\forall v \in V^j \mid 0 \leq j \leq v.depth : v.s[j] = s^j(v)$

where $v.depth := \max_i \{s^i(v)\}$ has been recomputed}.

```

AdaptiveSynthesis
   $\forall v \in V^0 : v.depth := 0$ 
  for  $i = 0$  to  $n - 1$ 
     $temptri := \{\}$ 
     $\forall t \in T^i :$ 
       $current := \{\}$ 
      Refine( $t, i, true$ )
     $\forall t \in temptri : if not t.restrict then$ 
      Delete children of  $t$ 

```

The list $temptri$ serves as a cache holding triangles from levels $j < i$ which are temporarily refined. A triangle is appended to the list if it was refined to compute a value at a vertex. After processing level i these triangles are unrefined unless their $t.restrict$ flag is set, indicating that a temporarily created triangle was later found to be needed permanently to ensure restriction. Since triangles are appended to $temptri$, parents precede children. Deallocating the list tail first guarantees that all unnecessary triangles are erased.

The function Refine(t, i, dir) (see below) creates children of $t \in T^i$ and computes the values $Ss^i(v)$ for the vertices and middle vertices of t . The results are stored in $v.s[i + 1]$. The boolean argument dir indicates whether the call was made directly or recursively.

```

Refine( $t, i, dir$ )

  if  $t.leaf$  then Create children for  $t$ 
   $\forall v \in t : if v.depth < i + 1$  then
    GetRing( $v, i$ )
    Update( $v, i$ )
     $\forall m \in N(v, i + 1, 1) :$ 
      Update( $m, i$ )
      if  $m.finest \geq i + 1$  then
         $forced := true$ 
  if  $dir$  and Flat( $t$ )  $< \epsilon_S$  and not  $forced$  then
    Delete children of  $t$ 
  else
     $\forall t \in current : t.restrict := true$ 

Update( $v, i$ )
   $v.s[i + 1] := subd(v, i)$ 
   $v.depth := i + 1$ 
  if  $v.finest \geq i + 1$  then
     $v.s[i + 1] += v.F(i + 1) * v.d[i + 1]$ 

```

The condition $v.depth = i + 1$ indicates whether an earlier call to Refine already recomputed $s^{i+1}(v)$. If not, call GetRing(v, i) and Update(v, i) to do so. In case a detail vector lives at v at level i ($v.finest \geq i + 1$) add it in. Next compute $s^{i+1}(m)$ for middle vertices on level $i + 1$ around v ($m \in N(v, i + 1, 1)$, where $N(v, i, l)$ is the l -ring neighborhood of vertex v at level i). If m has to be calculated, compute $subd(m, i)$ and add in the detail if it exists and record this fact in the flag $forced$ which will prevent unrefinement later. At this point, all s^{i+1} have been recomputed for the vertices and middle vertices of t . Unrefine t and delete its children if Refine was called directly, the triangle is sufficiently flat, and none of the middle vertices contain details (i.e., $forced = false$). The list $current$ functions as a cache holding triangles from level $i - 1$ which are temporarily refined to build a 1-ring around the vertices of t . If after processing all vertices and middle vertices of t it is decided that t will remain refined, none of the coarser-level triangles from $current$ can be unrefined without violating restriction. Thus $t.restrict$ is set for all of them. The function Flat(t) measures how close to planar the corners and edge middle vertices of t are.

Finally, GetRing(v, i) ensures that a complete ring of triangles on level i adjacent to the vertex v exists. Because triangles on level i are restricted triangles all triangles on level $i - 1$ that contain v exist (precondition). At least one of them is refined, since otherwise there would be no reason to call GetRing(v, i). All other triangles could be leaves or temporarily refined. Any triangle that was already temporarily refined may become permanently refined to enforce restriction. Record such candidates in the $current$ cache for fast access later.

```

GetRing( $v, i$ )

   $\forall t \in T^{i-1}$  with  $v \in t :$ 
    if  $t.leaf$  then
      Refine( $t, i - 1, false$ );  $temptri.append(t)$ 
       $t.restrict := false$ ;  $t.temp := true$ 
    if  $t.temp$  then
       $current.append(t)$ 

```

4.3 Local Synthesis

Even though the above algorithms are adaptive, they are still run everywhere. During an edit, however, not all of the surface changes. The most significant economy can be gained from performing analysis and synthesis only over submeshes which require it.

Assume the user edits level l and modifies the points $s^l(v)$ for $v \in V^{*l} \subset V^l$. This invalidates coarser level values s^i and d^i for certain subsets $V^{*i} \subset V^i$, $i \leq l$, and finer level points s^i for subsets $V^{*i} \subset V^i$ for $i > l$. Finer level detail vectors d^i for $i > l$ remain correct by definition. Recomputing the coarser levels is done by *local incremental analysis* described in Section 4.4, recomputing the finer level is done by *local synthesis* described in this section.

The set of vertices V^{*i} which are affected depends on the support of the subdivision scheme. If the support fits into an m -ring around the computed vertex, then all modified vertices on level $i + 1$ can be found recursively as

$$V^{*i+1} = \bigcup_{v \in V^{*i}} N(v, i+1, m).$$

We assume that $m = 2$ (Loop-like schemes) or $m = 3$ (Butterfly type schemes). We define the *subtriangulation* T^{*i} to be the subset of triangles of T^i with vertices in V^{*i} .

`LocalSynthesis` is only slightly modified from `AdaptiveSynthesis`: iteration starts at level l and iterates only over the submesh T^{*i} .

4.4 Local Incremental Analysis

After an edit on level l *local incremental analysis* will recompute $s^i(v)$ and $d^i(v)$ locally for coarser level vertices ($i \leq l$) which are affected by the edit. As in the previous section, we assume that the user edited a set of vertices v on level l and call V^{*i} the set of vertices affected on level i . For a given vertex $v \in V^{*i}$ we define

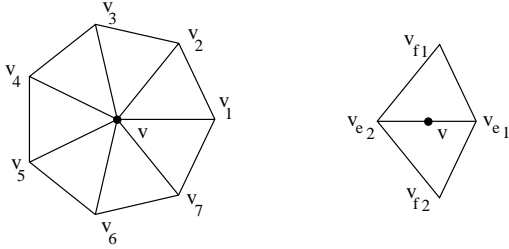

Figure 11: Sets of even vertices affected through smoothing by either an even v or odd m vertex.

$R^{i-1}(v) \subset V^{i-1}$ to be the set of vertices on level $i - 1$ affected by v through the smoothing operator H . The sets V^{*i} can now be defined recursively starting from level $i = l$ to $i = 0$:

$$V^{*i-1} = \bigcup_{v \in V^{*i}} R^{i-1}(v).$$

The set $R^{i-1}(v)$ depends on the size of the smoothing stencil and whether v is even or odd (cf. Fig. 11). If the smoothing filter is 1-ring, e.g., Gaussian, then $R^{i-1}(v) = \{v\}$ if v is even and $R^{i-1}(m) = \{v_{e1}, v_{e2}\}$ if m is odd. If the smoothing filter is 2-ring, e.g., Taubin, then $R^{i-1}(v) = \{v\} \cup \{v_k \mid 1 \leq k \leq K\}$ if v is even and $R^{i-1}(m) = \{v_{e1}, v_{e2}, v_{f1}, v_{f2}\}$ if v is odd. Because of restriction, these vertices always exist. For $v \in V^i$ and $v' \in R^{i-1}(v)$ we let $c(v, v')$ be the coefficient in the analysis stencil. Thus

$$(H s^i)(v') = \sum_{v \mid v' \in R^{i-1}(v)} c(v, v') s^i(v).$$

This could be implemented by running over the v' and each time computing the above sum. Instead we use the dual implementation, iterate over all v , accumulating $(+=)$ the right amount to $s^i(v')$ for $v' \in R^{i-1}(v)$. In case of a 2-ring Taubin smoother the coefficients are given by

$$\begin{aligned} c(v, v) &= (1 - \mu)(1 - \lambda) + \mu\lambda/6 \\ c(v, v_k) &= \mu\lambda/6K \\ c(m, v_{e1}) &= ((1 - \mu)\lambda + (1 - \lambda)\mu + \mu\lambda/3)/K \\ c(m, v_{f1}) &= \mu\lambda/3K, \end{aligned}$$

where for each $c(v, v')$, K is the outdegree of v' .

The algorithm first copies the old points $s^i(v)$ for $v \in V^{*i}$ and $i \leq l$ into the storage location for the detail. If then propagates the incremental changes of the modified points from level l to the coarser levels and adds them to the old points (saved in the detail locations) to find the new points. Then it recomputes the detail vectors that depend on the modified points.

We assume that before the edit, the old points $s^l(v)$ for $v \in V^{*l}$ were saved in the detail locations. The algorithm starts out by building V^{*i-1} and saving the points $s^{i-1}(v)$ for $v \in V^{*i-1}$ in the detail locations. Then the changes resulting from the edit are propagated to level $i - 1$. Finally $S s^{i-1}$ is computed and used to update the detail vectors on level i .

`LocalAnalysis(i)`

```

forall v in V^{*i} : forall v' in R^{i-1}(v) :
    V^{*i-1} += {v'}
    v'.d[i-1] := v'.s[i-1]
forall v in V^{*i} : forall v' in R^{i-1}(v) :
    v'.s[i-1] += c(v, v') * (v.s[i] - v.d[i])
forall v in V^{*i-1} :
    v.d[i] = v.F(i)^t * (v.s[i] - subd(v, i-1))
forall m in N(v, i, 1) :
    m.d[i] = m.F(i)^t * (m.s[i] - subd(m, i-1))

```

Note that the odd points are actually computed twice. For the Loop scheme this is less expensive than trying to compute a predicate to avoid this. For Butterfly type schemes this is not true and one can avoid double computation by imposing an ordering on the triangles. The top level code is straightforward:

`LocalAnalysis`

```

forall v in V^{*l} : v.d[l] := v.s[l]
for i := l downto 0
    LocalAnalysis(i)

```

It is difficult to make incremental local analysis adaptive, as it is formulated purely in terms of vertices. It is, however, possible to adaptively clean up the triangles affected by the edit and (un)refine them if needed.

4.5 Adaptive Rendering

The *adaptive rendering* algorithm decides which triangles will be drawn depending on the rendering performance available and level of detail needed.

The algorithm uses a flag $t.draw$ which is initialized to `false`, but set to `true` as soon as the area corresponding to t is drawn. This can happen either when t itself gets drawn, or when a set of its descendants, which cover t , is drawn. The top level algorithm loops through the triangles starting from the level $n - 1$. A triangle

is always responsible for drawing its children, never itself, unless it is a coarsest-level triangle.

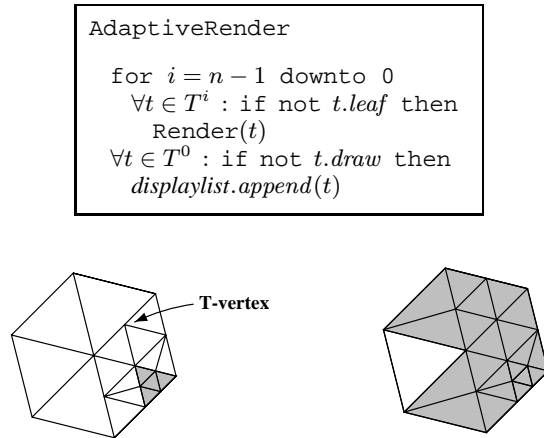

Figure 12: Adaptive rendering: On the left 6 triangles from level i , one has a covered child from level $i + 1$, and one has a T-vertex. On the right the result from applying Render to all six.

The $Render(t)$ routine decides whether the children of t have to be drawn or not (cf. Fig.12). It uses a function $edist(m)$ which measures the distance between the point corresponding to the edge's middle vertex m , and the edge itself. In the when case any of the children of t are already drawn or any of its middle vertices are far enough from the plane of the triangle, the routine will draw the rest of the children and set the draw flag for all their vertices and t . It also might be necessary to draw a triangle if some of its middle vertices are drawn because the triangle on the other side decided to draw its children. To avoid cracks, the routine $cut(t)$ will cut t into 2, 3, or 4, triangles depending on how many middle vertices are drawn.

Render(t)

```

if ( $\exists c \in t.child \mid c.draw = true$ 
or  $\exists m \in t.mid\_vertex \mid edist(m) > \epsilon_D$ ) then
   $\forall c \in t.child$  :
    if not  $c.draw$  then
       $displaylist.append(c)$ 
       $\forall v \in c : v.draw := true$ 
   $t.draw := true$ 
else if  $\exists m \in t.mid\_vertex \mid m.draw = true$ 
   $\forall t' \in cut(t) : displaylist.append(t')$ 
   $t.draw := true$ 

```

4.6 Data Structures and Code

The main data structure in our implementation is a forest of triangular quadtrees. Neighborhood relations within a single quadtree can be resolved in the standard way by ascending the tree to the least common parent when attempting to find the neighbor across a given edge. Neighbor relations between adjacent trees are resolved explicitly at the level of a collection of roots, i.e., triangles of a coarsest level graph. This structure also maintains an explicit representation of the boundary (if any). Submeshes rooted at any level can be created on the fly by assembling a new graph with some set of triangles as roots of their child quadtrees. It is here that the explicit representation of the boundary comes in, since the actual trees

are never copied, and a boundary is needed to delineate the actual submesh.

The algorithms we have described above make heavy use of container classes. Efficient support for sets is essential for a fast implementation and we have used the C++ Standard Template Library. The mesh editor was implemented using OpenInventor and OpenGL and currently runs on both SGI and Intel PentiumPro workstations.

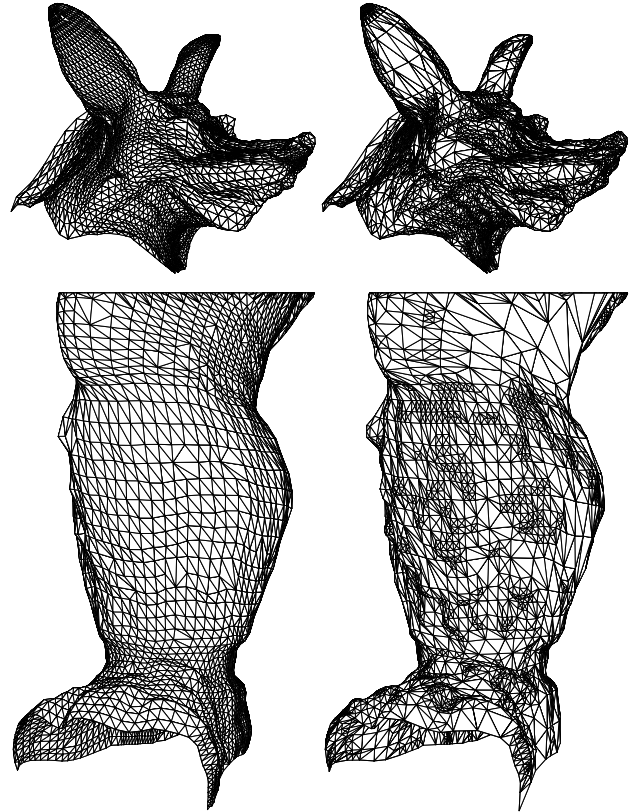

Figure 13: On the left are two meshes which are uniformly subdivided and consist of 11k (upper) and 9k (lower) triangles. On the right another pair of meshes mesh with approximately the same numbers of triangles. Upper and lower pairs of meshes are generated from the same original data but the right meshes were optimized through suitable choice of ϵ_S . See the color plates for a comparison between the two under shading.

5 Results

In this section we show some example images to demonstrate various features of our system and give performance measures.

Figure 13 shows two triangle mesh approximations of the Armadillo head and leg. Approximately the same number of triangles are used for both adaptive and uniform meshes. The meshes on the left were rendered uniformly, the meshes on the right were rendered adaptively. (See also color plate 15.)

Locally changing threshold parameters can be used to resolve an area of interest particularly well, while leaving the rest of the mesh at a coarse level. An example of this "lens" effect is demonstrated in Figure 14 around the right eye of the Mannequin head. (See also color plate 16.)

We have measured the performance of our code on two platforms: an Indigo R10000@175MHz with Solid Impact graphics, and a PentiumPro@200MHz with an Intergraph Intense 3D board.

We used the Armadillo head as a test case. It has approximately 172000 triangles on 6 levels of subdivision. Display list creation took 2 seconds on the SGI and 3 seconds on the PC for the full model. We adjusted ϵ_R so that both machines rendered models at 5 frames per second. In the case of the SGI approximately 113,000 triangles were rendered at that rate. On the PC we achieved 5 frames per second when the rendering threshold had been raised enough so that an approximation consisting of 35000 polygons was used.

The other important performance number is the time it takes to recompute and re-render the region of the mesh which is changing as the user moves a set of control points. This submesh is rendered in immediate mode, while the rest of the surface continues to be rendered as a display list. Grabbing a submesh of 20-30 faces (a typical case) at level 0 added 250 mS of time per redraw, at level 1 it added 110 mS and at level 2 it added 30 mS in case of the SGI. The corresponding timings for the PC were 500 mS, 200 mS and 60 mS respectively.

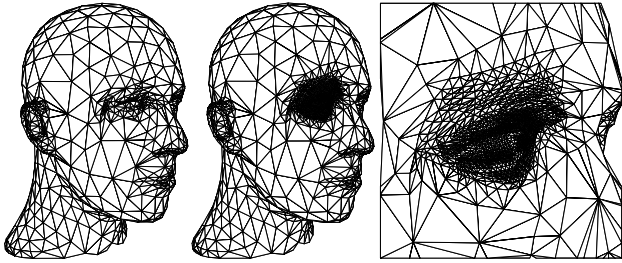

Figure 14: It is easy to change ϵ_S locally. Here a “lens” was applied to the right eye of the Mannequin head with decreasing ϵ_S to force very fine resolution of the mesh around the eye.

6 Conclusion and Future Research

We have built a scalable system for interactive multiresolution editing of arbitrary topology meshes. The user can either start from scratch or from a given fine detail mesh with *subdivision connectivity*. We use smooth subdivision combined with details at each level as a uniform surface representation across scales and argue that this forms a natural connection between fine polygonal meshes and patches. Interactivity is obtained by building both local and adaptive variants of the basic analysis, synthesis, and rendering algorithms, which rely on fast lazy evaluation and tree pruning. The system allows interactive manipulation of meshes according to the polygon performance of the workstation or PC used.

There are several avenues for future research:

- Multiresolution transforms readily connect with compression. We want to be able to store the models in a compressed format and use progressive transmission.
- Features such as creases, corners, and tension controls can easily be added into our system and expand the users' editing toolbox.
- Presently no real time fairing techniques, which lead to more intuitive coarse levels, exist.
- In our system coarse level edits can only be made by dragging coarse level vertices. Which vertices live on coarse levels is currently fixed because of subdivision connectivity. Ideally the user should be able to dynamically adjust this to make coarse level edits centered at arbitrary locations.
- The system allows topological edits on the coarsest level. Algorithms that allow topological edits on all levels are needed.
- An important area of research relevant for this work is generation of meshes with subdivision connectivity from scanned data or from existing models in other representations.

Acknowledgments

We would like to thank Venkat Krishnamurthy for providing the Armadillo dataset. Andrei Khodakovsky and Gary Wu helped beyond the call of duty to bring the system up. The research was supported in part through grants from the Intel Corporation, Microsoft, the Charles Lee Powell Foundation, the Sloan Foundation, an NSF CAREER award (ASC-9624957), and under a MURI (AFOSR F49620-96-1-0471). Other support was provided by the NSF STC for Computer Graphics and Scientific Visualization.

References

- [1] BURT, P. J., AND ADELSON, E. H. Laplacian Pyramid as a Compact Image Code. *IEEE Trans. Commun.* 31, 4 (1983), 532–540.
- [2] CATMULL, E., AND CLARK, J. Recursively Generated B-Spline Surfaces on Arbitrary Topological Meshes. *Computer Aided Design* 10, 6 (1978), 350–355.
- [3] CERTAIN, A., POPOVIĆ, J., DEROSE, T., DUCHAMP, T., SALESIN, D., AND STUETZLE, W. Interactive Multiresolution Surface Viewing. In *SIGGRAPH 96 Conference Proceedings*, H. Rushmeier, Ed., Annual Conference Series, 91–98, Aug. 1996.
- [4] DAHMEN, W., MICHELLI, C. A., AND SEIDEL, H.-P. Blossoming Begets B-Splines Bases Built Better by B-Patches. *Mathematics of Computation* 59, 199 (July 1992), 97–115.
- [5] DE BOOR, C. *A Practical Guide to Splines*. Springer, 1978.
- [6] DOO, D., AND SABIN, M. Analysis of the Behaviour of Recursive Division Surfaces near Extraordinary Points. *Computer Aided Design* 10, 6 (1978), 356–360.
- [7] DYN, N., LEVIN, D., AND GREGORY, J. A. A Butterfly Subdivision Scheme for Surface Interpolation with Tension Control. *ACM Trans. Gr.* 9, 2 (April 1990), 160–169.
- [8] ECK, M., DEROSE, T., DUCHAMP, T., HOPPE, H., LOUNSBERRY, M., AND STUETZLE, W. Multiresolution Analysis of Arbitrary Meshes. In *Computer Graphics Proceedings*, Annual Conference Series, 173–182, 1995.
- [9] FINKELSTEIN, A., AND SALESIN, D. H. Multiresolution Curves. *Computer Graphics Proceedings*, Annual Conference Series, 261–268, July 1994.
- [10] FORSEY, D., AND WONG, D. Multiresolution Surface Reconstruction for Hierarchical B-splines. Tech. rep., University of British Columbia, 1995.
- [11] FORSEY, D. R., AND BARTELS, R. H. Hierarchical B-Spline Refinement. *Computer Graphics (SIGGRAPH '88 Proceedings)*, Vol. 22, No. 4, pp. 205–212, August 1988.
- [12] GORTLER, S. J., AND COHEN, M. F. Hierarchical and Variational Geometric Modeling with Wavelets. In *Proceedings Symposium on Interactive 3D Graphics*, May 1995.
- [13] HOPPE, H. Progressive Meshes. In *SIGGRAPH 96 Conference Proceedings*, H. Rushmeier, Ed., Annual Conference Series, 99–108, August 1996.
- [14] HOPPE, H., DEROSE, T., DUCHAMP, T., HALSTEAD, M., JIN, H., McDONALD, J., SCHWEITZER, J., AND STUETZLE, W. Piecewise Smooth Surface Reconstruction. In *Computer Graphics Proceedings*, Annual Conference Series, 295–302, 1994.
- [15] HOPPE, H., DEROSE, T., DUCHAMP, T., McDONALD, J., AND STUETZLE, W. Mesh Optimization. In *Computer Graphics (SIGGRAPH '93 Proceedings)*, J. T. Kajiya, Ed., vol. 27, 19–26, August 1993.
- [16] KOBBELT, L. Interpolatory Subdivision on Open Quadrilateral Nets with Arbitrary Topology. In *Proceedings of Eurographics 96*, Computer Graphics Forum, 409–420, 1996.

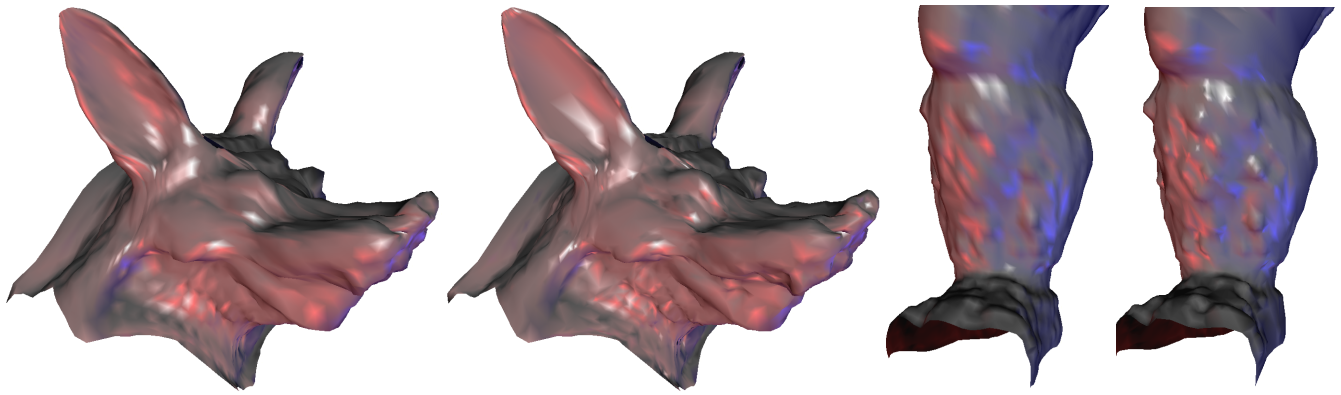

Figure 15: Shaded rendering (OpenGL) of the meshes in Figure 13.

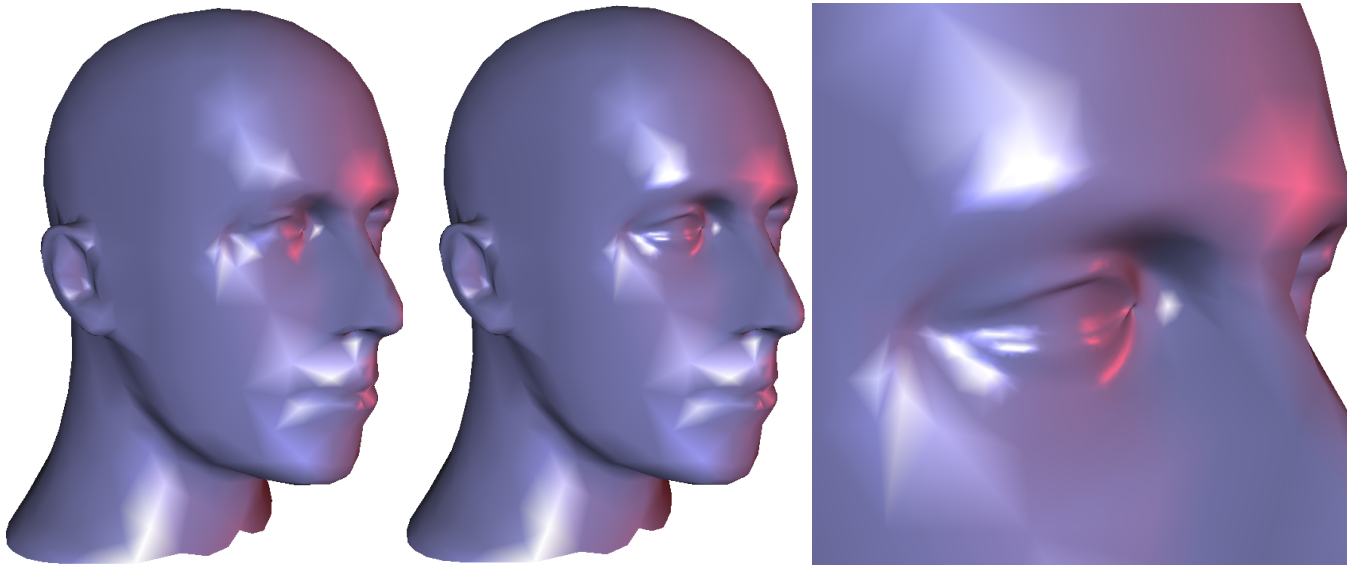

Figure 16: Shaded rendering (OpenGL) of the meshes in Figure 14.

- [17] KRISHNAMURTHY, V., AND LEVOY, M. Fitting Smooth Surfaces to Dense Polygon Meshes. In *SIGGRAPH 96 Conference Proceedings*, H. Rushmeier, Ed., Annual Conference Series, 313–324, August 1996.
- [18] KURIHARA, T. Interactive Surface Design Using Recursive Subdivision. In *Proceedings of Communicating with Virtual Worlds*. Springer Verlag, June 1993.
- [19] LOOP, C. Smooth Subdivision Surfaces Based on Triangles. Master's thesis, University of Utah, Department of Mathematics, 1987.
- [20] LOOP, C. Smooth Spline Surfaces over Irregular Meshes. In *Computer Graphics Proceedings*, Annual Conference Series, 303–310, 1994.
- [21] LOUNSBERY, M., DE ROSE, T., AND WARREN, J. Multiresolution Analysis for Surfaces of Arbitrary Topological Type. *Transactions on Graphics* 16, 1 (January 1997), 34–73.
- [22] PETERS, J. C^1 Surface Splines. *SIAM J. Numer. Anal.* 32, 2 (1995), 645–666.
- [23] PULLI, K., AND LOUNSBERY, M. Hierarchical Editing and Rendering of Subdivision Surfaces. Tech. Rep. UW-CSE-97-04-07, Dept. of CS&E, University of Washington, Seattle, WA, 1997.
- [24] SCHRÖDER, P., AND SWELDENS, W. Spherical wavelets: Efficiently representing functions on the sphere. *Computer Graphics Proceedings, (SIGGRAPH 95)* (1995), 161–172.
- [25] SCHWEITZER, J. E. *Analysis and Application of Subdivision Surfaces*. PhD thesis, University of Washington, 1996.
- [26] TAUBIN, G. A Signal Processing Approach to Fair Surface Design. In *SIGGRAPH 95 Conference Proceedings*, R. Cook, Ed., Annual Conference Series, 351–358, August 1995.
- [27] WELCH, W., AND WITKIN, A. Variational surface modeling. In *Computer Graphics (SIGGRAPH '92 Proceedings)*, E. E. Catmull, Ed., vol. 26, 157–166, July 1992.
- [28] ZORIN, D., SCHRÖDER, P., AND SWELDENS, W. Interpolating Subdivision for Meshes with Arbitrary Topology. *Computer Graphics Proceedings (SIGGRAPH 96)* (1996), 189–192.
- [29] ZORIN, D. N. *Subdivision and Multiresolution Surface Representations*. PhD thesis, Caltech, Pasadena, California, 1997.

Chapter 6

Interpolatory Subdivision for Quad Meshes

Speaker: Adi Levin

Combined Subdivision Schemes - an introduction

Adi Levin

April 7, 2000

Abstract

Combined subdivision schemes are a class of subdivision schemes that allow the designer to prescribe arbitrary boundary conditions. A combined subdivision scheme operates like an ordinary subdivision scheme in the interior of the surface, and applies special rules near the boundaries. The boundary rules at each iteration explicitly involve the given boundary conditions. They are designed such that the limit surfaces will satisfy the boundary conditions, and will have specific smoothness and approximation properties.

This article presents a short introduction to combined subdivision schemes and gives references to the author's works on the subject.

1 Background

The surface of a mechanical part is typically a piecewise smooth surface. It is also useful to think of it as the union of smooth surfaces that share boundaries. Those boundaries are key features of the object. In many applications, the accuracy required at the surface boundaries is more than the accuracy needed at the interior of the surface. In particular it is crucial that two neighboring surfaces do not have gaps between them along their common boundary. Gaps that appears in the mathematical model cause algorithmic difficulties in processing these surfaces. However, commonly used spline models cannot avoid these gaps.

A boundary curve between two surfaces represents their intersection. Even for simple surfaces such as bicubic polynomial patches the intersection curve is known to be a polynomial of very high degree. A compromise is then made by approximating the actual intersection curve within specified error tolerance, and thus a new problem appears: the approximate curve cannot lie on both surfaces. Therefore one calculates two approximations for the same curve, each one lying on one of the surfaces, hence the new surface boundaries have a gap between them.

The same thing happens with other surface models that represent a surface by a discrete set of control points, including subdivision schemes. Combined subdivision schemes offer an alternative. In the new setting, the designer can prescribe the boundary curves of the surface exactly. Therefore, in order to force two surfaces to share a common boundary without gaps, we only need to calculate the boundary curve, and require each of the two surfaces to interpolate that curve.

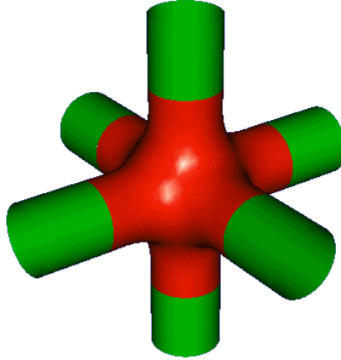

Figure 1: A smooth blending between six cylinders.

While boundary curves are crucial for the continuity of the model, other boundary conditions are also of interest. It is sometimes desirable to have two neighboring surfaces connect smoothly along their shared boundary. Figure 1 shows six cylinders blended smoothly by a surface. Combined subdivision schemes offer that capability as well.

2 The principle of combined subdivision

Combined subdivision schemes provide a general framework for designing subdivision surfaces that satisfy prescribed boundary conditions. In the standard subdivision approach, the surface is defined only by its control points. Given boundary conditions, one tries to find a configuration of control points for which the surface satisfies the boundary conditions. In combined subdivision schemes the boundary conditions play a role which is equivalent to that of the control points. Every iteration of subdivision is affected by the boundary conditions.

Hence, standard subdivision can be described as the linear process

$$P^{n+1} = SP^n, \quad n = 0, 1, \dots,$$

where P^n stands for control points after n iterations of subdivision, and S stands for the subdivision operator. In these notations, a combined subdivision scheme will be described by

$$P^{n+1} = SP^n + (\text{Boundary contribution}), \quad n = 0, 1, \dots$$

The name *combined subdivision schemes* comes from the fact that every iteration of the scheme combines discrete data, i.e. the control points, with continuous (or *transfinite*) data, i.e. the boundary conditions. Using this approach, a simple subdivision algorithm can yield limit surfaces that satisfy the prescribed boundary conditions.

3 Related work

In this section we discuss previous known works in the subject of subdivision surfaces with boundaries. All of these works employ the standard notion of subdivision, i.e. a process where control points are recursively refined. Thus, the subdivision surface is described by a given set of control points, and a set of subdivision rules. The subdivision rules that are applied near the surface boundary may differ from those used in the interior of the surface.

In [8], Loop's subdivision scheme is extended to create piecewise surfaces, by introducing special subdivision rules that apply near crease edges and other non-smooth features. The crease rules introduced in [8] can also be used as boundary rules. However, these boundary rules do not satisfy the requirement that the boundary curve depends only on the control points on the boundary of the control net. Bierman et al. [9] improve these boundary rules such that the boundary curve depends only on the boundary control polygon, and introduce similar boundary rules for the Catmull-Clark scheme. Their subdivision rules also enable control over the tangent planes of the surface at the boundaries.

Kobbelt [1] introduced an interpolatory subdivision scheme for quadrilateral control nets which generalizes the tensor-product 4-point scheme and has special subdivision rules near the boundaries. Nasri [7] considered the interpolation of quadratic B-spline curves by limit surfaces of the Doo-Sabin scheme. The conditions he derived can be used to determine the boundary points of a Doo-Sabin control net such that the limit surface interpolates a prescribed B-spline curve at the boundary.

In all of these works, specific subdivision schemes are considered, and the boundary curves are restricted to spline curves or to subdivision curves. The notion of combined subdivision enables the designer to prescribe arbitrary boundary curves. Moreover, we have a generalized framework for constructing combined subdivision schemes, based on any known subdivision scheme, and for a large class of boundary conditions.

In addition, all of these previous works only established the smoothness of the limit surfaces resulting from their proposed subdivision schemes. In the theory of combined subdivision schemes, both the smoothness and the approximation properties of the new schemes were studied, as it was recognized that for CAGD applications the quality of approximation is a major concern.

4 Works on Combined Subdivision Schemes

In this section, the current works on combined subdivision schemes are listed. All of the manuscripts are available at <http://www.math.tau.ac.il/~adilev>.

The definition and the theoretical analysis of combined subdivision schemes are developed in [5]. This work also contains several detailed examples of constructions of new subdivision schemes with prescribed smoothness and approximation properties, and of their applications. The schemes in [5] include extensions of Loop, Catmull-Clark, Doo-Sabin and the Butterfly scheme.

An important aspect of the smoothness analysis of combined subdivision schemes is the analysis of a subdivision scheme across an *extraordinary line*, namely, an area of

the surface around a given edge or curve where special subdivision rules are applied. Analysis tools for such cases are given in [2]. This is also of interest for constructing boundary rules for ordinary subdivision schemes, since boundaries can typically be viewed as extraordinary lines.

In [3], several simple combined subdivision schemes are presented, that can handle prescribed boundary curves, and prescribed cross-boundary derivatives, as extensions of Loop's scheme and of the Catmull-Clark scheme.

In [4] a combined subdivision scheme for the interpolation of nets of curves is presented. This scheme is based on a variant of the Catmull-Clark scheme. The generated surfaces can interpolate nets of curves of arbitrary topology, as long as no more than two curves intersect at one point.

In [6] a specially designed combined subdivision scheme is used for filling N -sided holes, while maintaining C^1 contact with the neighboring surfaces. This offers an elegant alternative to current methods for N -sided patches.

References

- [1] L. Kobbelt, T. Hesse, H. Prautzsch, and K. Schweizerhof. Interpolatory subdivision on open quadrilateral nets with arbitrary topology. *Computer Graphics Forum*, 15:409–420, 1996. Eurographics '96 issue.
- [2] A. Levin. Analysis of quazi-uniform subdivision schemes. in preparation, 1999.
- [3] A. Levin. Combined subdivision schemes for the design of surfaces satisfying boundary conditions. *Computer Aided Geometric Design*, 16(5):345–354, 1999.
- [4] A. Levin. Interpolating nets of curves by smooth subdivision surfaces. In *Proceedings of SIGGRAPH 99, Computer Graphics Proceedings, Annual Conference Series*, pages 57–64, 1999.
- [5] A. Levin. *Combined Subdivision Schemes with Applications to Surface Design*. PhD thesis, Tel-Aviv university, 2000.
- [6] A. Levin. Filling n-sided holes using combined subdivision schemes. In Paul Sablonnière Pierre-Jean Laurent and Larry L. Schumaker (eds.), editors, *Curve and Surface Design: Saint-Malo 1999*. Vanderbilt University Press, Nashville, TN, 2000.
- [7] A. H. Nasri. Curve interpolation in recursively generated b-spline surfaces over arbitrary topology. *Computer Aided Geometric Design*, 14:No 1, 1997.
- [8] J. Schweitzer. *Analysis and Applications of Subdivision Surfaces*. PhD thesis, University of Washington, Seattle, 1996.
- [9] D. Zorin, H. Biermann, and A. Levin. Piecewise smooth subdivision surfaces with normal control. Technical Report TR1999-781, New York University, February 26, 1999.

A Combined Subdivision Scheme For Filling Polygonal Holes

Adi Levin

April 7, 2000

Abstract

A new algorithm is presented for calculating N -sided surface patches that satisfy arbitrary C^1 boundary conditions. The algorithm is based on a new subdivision scheme that uses Catmull-Clark refinement rules in the surface interior, and specially designed boundary rules that involve the given boundary conditions. The new scheme falls into the category of Combined Subdivision Schemes, that enable the designer to prescribe arbitrary boundary conditions. The generated subdivision surface has continuous curvature except at one extraordinary middle point. Around the middle point the surface is C^1 continuous, and the curvature is bounded.

1 Background

The problem of constructing N -sided surface patches occurs frequently in computer-aided geometric design. The N -sided patch is required to connect smoothly to given surfaces surrounding a polygonal hole, as shown in Fig. 1.

Referring to [10, 25, 26], N -sided patches can be generated basically in two ways. Either the polygonal domain, which is to be mapped into 3D, is subdivided in the parametric plane, or one uniform equation is used to represent the entire patch. In the former case, triangular or rectangular elements are put together [2, 6, 12, 20, 23] or recursive subdivision methods are applied [5, 8, 24]. In the latter case, either the known control-point based methods are generalized or a weighted sum of 3D interpolants gives the surface equation [1, 3, 4, 22].

The method presented in this paper is a recursive subdivision scheme specially designed to consider arbitrary boundary conditions. Subdivision schemes provide effi-

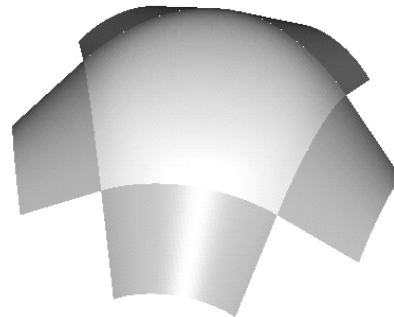

Figure 1: A 5 sided surface patch

cient algorithms for the design, representation and processing of smooth surfaces of arbitrary topological type. Their simplicity and their multiresolution structure make them attractive for applications in 3D surface modeling, and in computer graphics [7, 9, 11, 13, 19, 27, 28].

The subdivision scheme presented in this paper falls into the category of *combined subdivision schemes* [14, 15, 17, 18], where the underlying surface is represented not only by a control net, but also by the given boundary conditions. The scheme repeatedly applies a subdivision operator to the control net, which becomes more and more dense. In the limit, the vertices of the control net converge to a smooth surface. Samples of the boundary conditions participate in every iteration of the subdivision, and as a result the limit surface satisfies the given conditions, regardless of their representation. Thus, our scheme performs so-called transfinite interpolation.

The motivation behind the specific subdivision rules, and the smoothness analysis of the scheme are presented

in [16]. In the following sections, we describe Catmull-Clark's scheme, and we present the details of our scheme.

2 Catmull-Clark Subdivision

A net $\Sigma = (V, E)$ consists of a set of vertices V and the topological information of the net E , in terms of edges and faces. A net is closed when each edge is shared by exactly two faces.

Camull-Clark's subdivision scheme is defined over closed nets of arbitrary topology, as an extension of the tensor product bi-cubic B-spline subdivision scheme [5, 8]. Variants of the original scheme were analyzed by Ball and Storry [24]. Our algorithm employs a variant of Catmull-Clark's scheme due to Sabin [21], which generates limit surfaces that are C^2 -continuous everywhere except at a finite number of irregular points. In the neighborhood of those points the surface curvature is bounded. The irregular points come from vertices of the original control net that have valency other than 4, and from faces of the original control net that are not quadrilateral.

Given a net Σ , the vertices V' of the new net $\Sigma' = (V', E')$ are calculated by applying the following rules on Σ (see Fig. 2):

1. For each old face f , make a new face-vertex $v(f)$ as the weighted average of the old vertices of f , with weights W_m that depend on the valency m of each vertex.
2. For each old edge e , make a new edge-vertex $v(e)$ as the weighted average of the old vertices of e and the new face vertices associated with the two faces originally sharing e . The weights W_m (which are the same as the weights used in rule 1) depend on the valency m of each vertex.
3. For each old vertex v , make a new vertex-vertex $v(v)$ at the point given by the following linear combination, whose coefficients $\alpha_m, \beta_m, \gamma_m$ depend on the valency m of v :

$\alpha_m \cdot$ (the centroid of the new edge vertices of the edges meeting at v) + $\beta_m \cdot$ (the centroid of the new face vertices of the faces sharing those edges) + $\gamma_m \cdot v$.

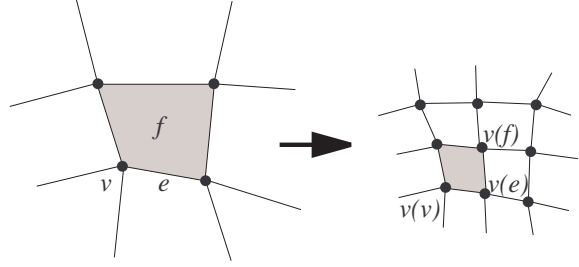

Figure 2: Catmull-Clark's scheme

The topology E' of the new net is calculated by the following rule: For each old face f and for each vertex v of f , make a new quadrilateral face whose edges join $v(f)$ and $v(v)$ to the edge vertices of the edges of f sharing v (see Fig. 2).

We present the procedure for calculating the weights mentioned above, as formulated by Sabin in [21]: Let $m > 2$ denote a vertex valency. Let $k := \cos(\pi/m)$. Let x be the unique real root of

$$x^3 + (4k^2 - 3)x - 2k = 0,$$

satisfying $x > 1$. Then

$$W_m = x^2 + 2kx - 3, \quad \alpha_m = 1,$$

$$\gamma_m = \frac{kx + 2k^2 - 1}{x^2(kx + 1)}, \quad \beta_m = -\gamma_m.$$

Remark: The original paper by Sabin [21] contains a mistake: the formulas for the parameters α, β and γ that appear in §4 there, are $\beta := 1, \gamma := -\alpha$.

3 The Boundary Conditions

The input to our scheme consists of N smooth curves given in a parametric representation $c_j : [0, 2] \rightarrow \mathbb{R}^3$ over the parameter interval $[0, 2]$, and corresponding cross-boundary derivative functions $d_j : [0, 2] \rightarrow \mathbb{R}^3$ (see Fig. 3). We say that the boundary conditions are C^0 -compatible at the j -th corner if

$$c_j(2) = c_{j+1}(0).$$

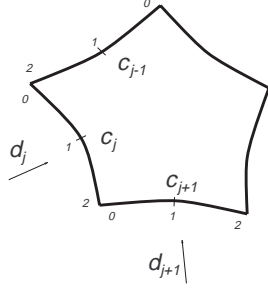

Figure 3: The input data

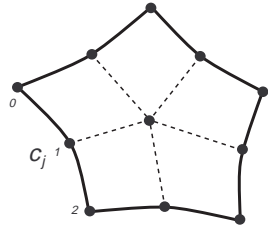

Figure 4: The initial control net (right)

We say that the boundary conditions are C^1 -compatible if

$$\begin{aligned} d_j(0) &= -c'_{j-1}(2), \\ d_j(2) &= c'_{j+1}(0). \end{aligned}$$

We say that the boundary conditions are C^2 -compatible if the curves c_j have Hölder continuous second derivatives, the functions d_j have Hölder continuous derivatives, and the following twist compatibility condition is satisfied:

$$d'_j(2) = -d'_{j+1}(0). \quad (1)$$

The requirement of Hölder continuity is used in [16] for the proof of C^2 -continuity in case the boundary conditions are C^2 -compatible.

4 The Algorithm

In this section we describe our algorithm for the design of an N -sided patch satisfying the boundary conditions described in §3. The key ingredients of the algorithm are two formulas for calculating the boundary vertices of the net. These formulas are given in §4.3 and §4.4.

4.1 Constructing an initial control net

The algorithm starts by constructing an initial control net whose faces are all quadrilateral with $2N$ boundary vertices and one middle vertex, as shown in Fig. 4. The boundary vertices are placed at the parameter values 0, 1, 2 on the given curves. The middle vertex can be arbitrarily chosen by the designer, and controls the shape of the resulting surface.

4.2 A single iteration of subdivision

We denote by n the iteration number, where $n = 0$ corresponds to the first iteration. In the n -th iteration we perform three steps: First, we relocate the boundary vertices according to the rules given below in §4.3 - §4.4. Then, we apply Sabin's variant of Catmull-Clark's scheme to calculate the new net topology and the position of the new internal vertices. For the purpose of choosing appropriate weights in the averaging process, we consider the boundary vertices as if they all have valency 4. This makes up for the fact that the net is not closed. In the third and final step, we sample the boundary vertices from the given curves at uniformly spaced parameter values with interval length $2^{-(n+1)}$.

4.3 A smooth boundary rule

Let v denote a boundary vertex corresponding to the parameter $0 < u < 2$ on the curve c_j . Let w denote the unique internal vertex which shares an edge with v (see Fig. 5). In the first step of the n -th iteration we calculate the position of the v by the formula

$$\begin{aligned} v &= 2c_j(u) - \frac{1}{4} (c_j(u + 2^{-n}) + c_j(u - 2^{-n})) - \\ &\quad - 2^{-n} \frac{1}{12} (d_j(u + 2^{-n}) + d_j(u - 2^{-n})) - \end{aligned}$$

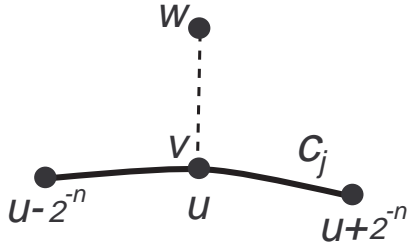

Figure 5: The stencil for the smooth boundary rule

$$\frac{1}{2}w + 2^{-n}\frac{2}{3}d_j(u).$$

4.4 A corner rule

Let v denote a boundary vertex corresponding to the point $c_{j-1}(2) = c_j(0)$. Let w be the unique internal vertex sharing a face with v (see Fig. 6). In the first step of the n -th iteration we calculate the position of v by the formula

$$\begin{aligned} v &= \frac{5}{2}c_j(0) - (c_j(2^{-n}) + c_{j-1}(2 - 2^{-n})) + \\ &\quad \frac{1}{8}c_j(2^{1-n}) + \frac{1}{8}c_{j-1}(2 - 2^{1-n}) + \\ &\quad 2^{-n}\frac{29}{48}(d_j(0) + d_{j-1}(2)) + \frac{1}{4}w - \\ &\quad 2^{-n}\frac{1}{12}(d_j(2^{-n}) + d_{j-1}(2 - 2^{-n})) - \\ &\quad 2^{-n}\frac{1}{48}(d_j(2^{1-n}) + d_{j-1}(2 - 2^{1-n})). \end{aligned}$$

5 Properties of the scheme

In [16] we prove that the vertices generated by the above procedure converge to a surface which is C^2 -continuous almost everywhere, provided that the boundary conditions are C^2 -compatible (as defined in §3). The only point where the surface is not C^2 -continuous is a middle-point (corresponding to the middle vertex, which has valency N), where the surface is only G^1 -continuous. In the neighborhood of this extraordinary point, the surface curvature is bounded.

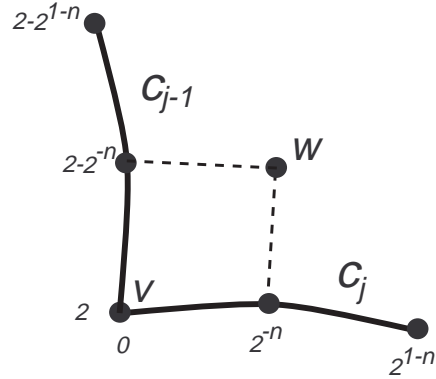

Figure 6: The stencils for the corner rule

The limit surface interpolates the given curves, for C^0 -compatible boundary conditions. For C^1 -compatible boundary conditions, the tangent plane of the limit surface at the point $c_j(u)$ is spanned by the vectors $c'_j(u)$ and $d_j(u)$, thus the surface satisfies C^1 -boundary conditions. Furthermore, due to the locality of this scheme, the limit surface is C^2 near the boundaries except at points where the C^2 -compatibility condition is not satisfied.

The surfaces in Fig. 7 and Fig. 8 demonstrate that the limit surface behaves moderately even in the presence of wavy boundary conditions. The limit surfaces are C^2 -continuous near the boundary except at corners where the twist compatibility condition (1) is not satisfied.

References

- [1] R. E. Barnhill, Computer aided surface representation and design, in Surfaces in CAGD, R. E. Barnhill and W. Boehm, editors, North-Holland, Amsterdam, 1986, 1–24.
- [2] E. Becker, Smoothing of shapes designed with free-form surfaces, Computer Aided Design, 18(4), 1986, 224–232.
- [3] W. Boehm, Triangular spline algorithms, Computer Aided Geometric Design 2(1), 1985, 61–67.

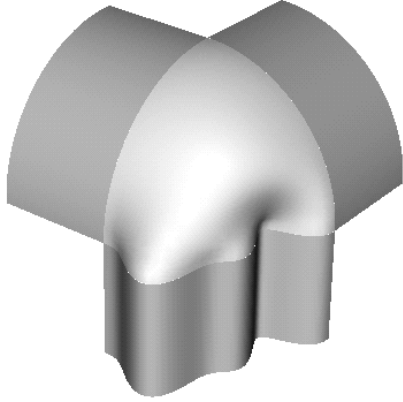

Figure 7: A 3-sided surface patch with wavy boundary curves

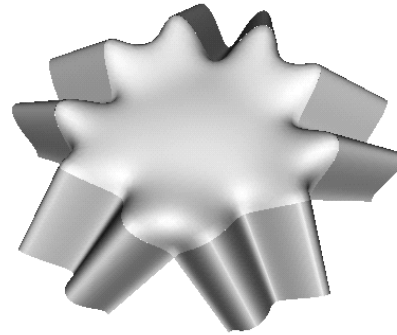

Figure 8: A 5-sided surface patch with wavy boundary curves

- [4] W. Boehm, G. Farin, and J. Kahmann, A survey of curves and surface methods in cagd, *Computer Aided Geometric Design* 1(1), 1985, 1–60.
- [5] E. Catmull and J. Clark, Recursively generated b-spline surfaces on arbitrary topological meshes, *Computer Aided Design* 10, 1978, 350–355.
- [6] H. Chiokura, Localized surface interpolation method for irregular meshes, in *Advanced Computer Graphics, Proc. Comp. Graphics*, L. Kunii, editor, Tokyo, Springer, Berlin, 1986.
- [7] T. DeRose, M. Kass, and T. Truong, Subdivision surfaces in character animation, in *SIGGRAPH 98 Conference Proceedings*, Annual Conference Series, ACM SIGGRAPH, 1998, 85–94.
- [8] D. Doo and M. Sabin, Behaviour of recursive division surface near extraordinary points, *Computer Aided Design* 10, 1978, 356–360.
- [9] N. Dyn, J. A. Gregory, and D. Levin, A butterfly subdivision scheme for surface interpolation with tension control, *ACM Transactions on Graphics* 9, 1990, 160–169.
- [10] J. A. Gregory, V. K. H. Lau, and J. Zhou, Smooth parametric surfaces and N -sided patches, in *Computation of Curves and Surfaces*, ASI Series, W. Dahmen, M. Gasca, and C. A. Micchelli, editors, Kluwer Academic Publishers, Dordrecht, 1990, 457–498.
- [11] M. Halstead, M. Kass, and T. DeRose, Efficient, fair interpolation using catmull-clark surfaces, in *SIGGRAPH 93 Conference Proceedings*, Annual Conference series, ACM SIGGRAPH, 1993, 35–44.
- [12] G. J. Herron, Triangular and multisided patch schemes, PhD thesis, University of Utah, Salt Lake City, UT, 1979.
- [13] L. Kobbelt, T. Hesse, H. Prautzsch, and K. Schweizerhof, Interpolatory subdivision on open quadrilateral nets with arbitrary topology, *Computer Graphics Forum* 15, Eurographics '96 issue, 1996, 409–420.
- [14] A. Levin, Analysis of combined subdivision schemes 1, Submitted, 1999, Available on the web at the author's home-page.
- [15] A. Levin, Analysis of combined subdivision schemes 2, In preparation, 1999, Available on the web at the author's home-page.
- [16] A. Levin, Combined Subdivision Schemes, PhD thesis, Tel-Aviv university, 2000.

- [17] A. Levin, Combined subdivision schemes for the design of surfaces satisfying boundary conditions, *Computer Aided Geometric Design* 16(5), 1999, 345-354.
- [18] A. Levin, Interpolating nets of curves by smooth subdivision surfaces, *Proceedings of SIGGRAPH 99, Computer Graphics Proceedings, Annual Conference Series*, 1999, 57-64.
- [19] C. Loop, Smooth spline surfaces based on triangles. Master's thesis, University of Utah, Department of Mathematics, 1987.
- [20] E. Nadler, A practical approach to N -sided patches, presented at the Fourth SIAM Conference on Geometric Design, Nashville, 1995.
- [21] M. Sabin, Cubic recursive division with bounded curvature, In *Curves and Surfaces*, P. J. Laurent, A. le Mehaute, and L. L. Schumaker, editors, Academic Press, 1991, pages 411-414.
- [22] M. A. Sabin, Some negative results in N -sided patches, *Computer Aided Design* 18(1), 1986, 38-44.
- [23] R. F. Sarraga, G^1 interpolation of generally unrestricted cubic Bézier curves, *Computer Aided Geometric Design* 4, 1987, 23-29.
- [24] D. J. T. Storry and A. A. Ball, Design of an N -sided surface patch, *Computer Aided Geometric Design* 6, 1989, 111-120.
- [25] T. Varady, Survey and new results in n -sided patch generation, In *The Mathematics of Surfaces II*, R. Martin, editor, Oxford Univ., 1987, 203-235.
- [26] T. Varady, Overlap patches: a new scheme for interpolating curve networks with N -sided regions, *Computer Aided Geometric Design* 8, 1991, 7-27.
- [27] D. Zorin, P. Schröder, and W. Sweldens, Interpolating subdivision for meshes with arbitrary topology, *Computer Graphics Proceedings (SIGGRAPH 96)*, 1996, 189-192.
- [28] D. Zorin, P. Schröder, and W. Sweldens, Interactive multiresolution mesh editing, *Computer Graphics Proceedings (SIGGRAPH 97)*, 1997, 259-268.

Interpolating Nets Of Curves By Smooth Subdivision Surfaces

Adi Levin*

Tel Aviv University

Abstract

A subdivision algorithm is presented for the computation and representation of a smooth surface of arbitrary topological type interpolating a given net of smooth curves. The algorithm belongs to a new class of subdivision schemes called *combined subdivision schemes*. These schemes can exactly interpolate a net of curves given in any parametric representation. The surfaces generated by our algorithm are G^2 except at a finite number of points, where the surface is G^1 and has bounded curvature. The algorithm is simple and easy to implement, and is based on a variant of the famous Catmull-Clark subdivision scheme.

1 INTRODUCTION

Subdivision schemes provide efficient algorithms for the design, representation and processing of smooth surfaces of arbitrary topological type. Their simplicity and their multiresolution structure make them attractive for applications in 3D surface modeling, and in computer graphics [2, 4, 5, 6, 11, 18].

A common task in surface modeling is that of interpolating a given net of smooth curves by a smooth surface. A typical solution, using either subdivision surfaces or NURBS surfaces (or other kinds of spline surfaces), is based on establishing the connection between parts of the control net which defines the surface, and certain curves on the surface. For example, the boundary curves of NURBS surfaces are NURBS curves whose control polygon is the boundary polygon of the NURBS surface control net. Hence, curve interpolation conditions are translated into conditions on the control net. Fairing techniques [5, 15, 17] can be used to calculate a control net satisfying those conditions. Using subdivision surfaces, this can be carried out, in general, for given nets of arbitrary topology (see [12, 13]).

However, the curves that can be interpolated using that approach are restricted by the representation chosen for the surface. NURBS surfaces are suitable for interpolating NURBS curves; Doo-Sabin surfaces can interpolate quadratic B-spline curves [12, 13]; Other kinds of subdivision surfaces can be shown to interpolate specific kinds of subdivision curves. Furthermore, interpolation of curves that have small features requires a large control net, making the fairing process slower and more complicated.

This paper presents a new subdivision scheme specially designed for the task of interpolating nets of curves. This scheme falls into

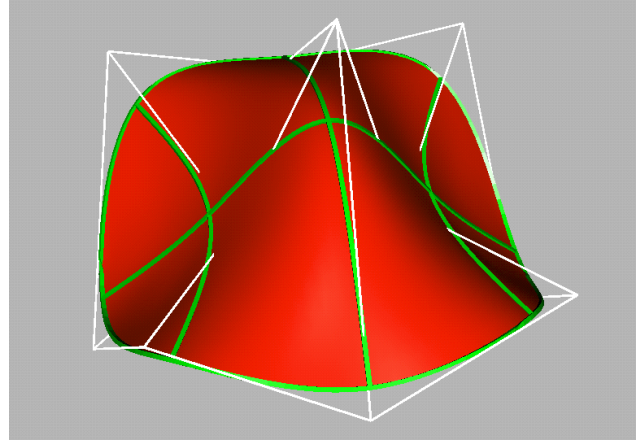

Figure 1: Interpolation of a net of curves

the category of *combined subdivision schemes* [7, 8, 10], where the underlying surface is represented not only by a control net, but also by given parametric curves (or in general, given interpolation conditions or boundary conditions). The scheme repeatedly applies a subdivision operator to the control net, which becomes more and more dense. In the limit, the vertices of the control net converge to a smooth surface. Point-wise evaluations of the given curves participate in every iteration of the subdivision, and the limit surface interpolates the given curves, regardless of their representation.

Figure 1 illustrates a surface generated by our algorithm. The surface is defined by an initial control net that consists of 11 vertices, and by a net of intersecting curves, shown in green. The edges of the control net are shown as white lines.

The combined subdivision scheme presented in this paper is based on the famous Catmull-Clark subdivision scheme. Our algorithm applies Catmull-Clark's scheme almost everywhere on the control net. The given curves affect the control net only locally, at parts of the control net that are near the given curves.

The motivation behind the specific subdivision rules, and the smoothness analysis of the scheme are presented in [9]. In the following sections, we describe Catmull-Clark's scheme, and we present the details of our scheme.

2 CATMULL-CLARK'S SCHEME

Camull Clark's subdivision scheme is defined over closed nets of arbitrary topology, as an extension of the tensor product bi-cubic B-spline subdivision scheme (see [1, 3]). Variants of the original scheme were analyzed by Ball and Storry [16]. Our algorithm employs a variant of Catmull-Clark's scheme due to Sabin [14], which generates limit surfaces that are G^2 everywhere except at a finite number of irregular points. In the neighborhood of those points the surface curvature is bounded. The irregular points come from vertices of the original control net that have valency other than 4, and from faces of the original control net that are not quadrilateral.

*adilev@math.tau.ac.il, <http://www.math.tau.ac.il/~adilev>

A net $N = (V, E)$ consists of a set of vertices V and the topological information of the net E , in terms of edges and faces. A net is closed when each edge is shared by exactly two faces.

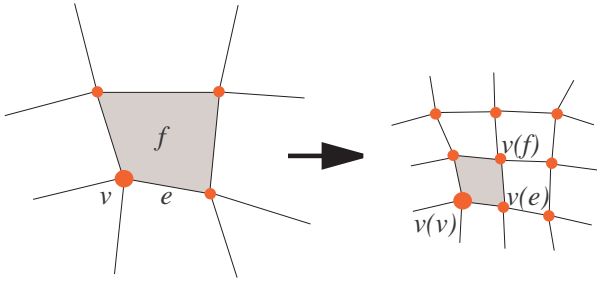

Figure 2: Catmull-Clark's scheme.

The vertices V' of the new net $N' = (V', E')$ are calculated by applying the following rules on N (see figure 2):

1. For each old face f , make a new face-vertex $v(f)$ as the weighted average of the old vertices of f , with weights W_n that depend on the valency n of each vertex.
2. For each old edge e , make a new edge-vertex $v(e)$ as the weighted average of the old vertices of e and the new face vertices associated with the two faces originally sharing e . The weights W_n (which are the same as the weights used in rule 1) depend on the valency n of each vertex.
3. For each old vertex v , make a new vertex-vertex $v(v)$ at the point given by the following linear combination, whose coefficients $\alpha_n, \beta_n, \gamma_n$ depend on the valency n of v :

$\alpha_n \cdot$ (the centroid of the new edge vertices of the edges meeting at v) + $\beta_n \cdot$ (the centroid of the new face vertices of the faces sharing those edges) + $\gamma_n \cdot v$.

The topology E' of the new net is calculated by the following rule:

For each old face f and for each vertex v of f , make a new quadrilateral face whose edges join $v(f)$ and $v(v)$ to the edge vertices of the edges of f sharing v (see figure 2).

The formulas for the weights $\alpha_n, \beta_n, \gamma_n$ and W_n are given in the appendix.

3 THE CONTROL NET

Our subdivision algorithm is defined both on closed nets and on open nets. In the case of open nets, we make a distinction between *boundary vertices* and *internal vertices* (and between *boundary edges* and *internal edges*). The control net that is given as input to our scheme consists of vertices, edges, faces and given smooth curves. We assume that these are C^2 parametric curves. An edge which is associated with a segment of a curve, is called a *c-edge*. Both of its vertices are called *c-vertices*. All the other edges and vertices are *ordinary vertices* and *ordinary edges*.

In case two c-edges that share a c-vertex are associated with two different curves, the c-vertex is associated with two curves, and we call it an *intersection vertex*. Every *c-vertex* is thus associated with a parameter value on a curve, while *intersection vertices* are associated with two curves and two different parameter values. In case

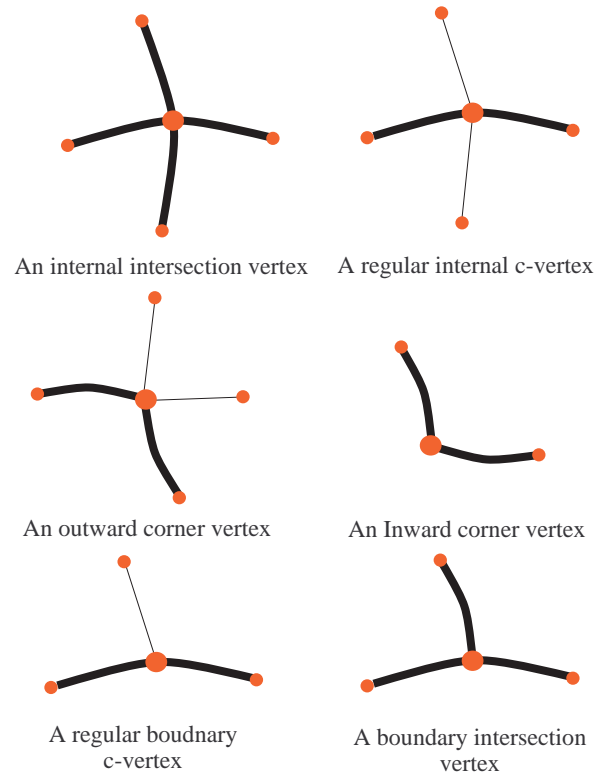

Figure 3: The different kinds of c-vertices. C-edges are marked by bold curved lines. Usual edges are shown as thin lines.

of intersection vertices, we require that the two curves intersect at those parameter values.

Every *c-edge* contains a pointer to a curve c , and to a segment on that curve designated by a parameter interval $[u_0, u_1]$. The vertices of that edge are associated with the points $c(u_0)$ and $c(u_1)$ respectively. We require that in the original control net, the parameter intervals be all of constant length for all the c-edges associated with a single curve c , namely $|u_1 - u_0| = \text{const}$. In order to fulfill this requirement, the c-vertices along a curve c can be chosen to be evenly spaced with respect to the parameterization of the curve c , or the curve c can be reparameterized appropriately such that the c-vertices of c are evenly spaced with respect to the new parameterization.

The restrictions on the control net are that every boundary edge is a c-edge (i.e. the given net of curves contains all the boundary curves of the surface), and that we allow only the following types of *c-vertices* to exist in the net (see figure 3):

A regular internal c-vertex A c-vertex with four edges emanating from it: Two c-edges that are associated with the same curve, and two ordinary edges from opposite sides of the curve.

A regular boundary c-vertex A c-vertex with 3 edges emanating from it: Two boundary edges that are associated with the same curve, and one other ordinary internal edge.

An internal intersection vertex A c-vertex with 4 edges emanating from it: Two c-edges that are associated with the same curve, and two other c-edges that are associated with a second curve, from opposite sides of the first curve.

A boundary intersection vertex A c-vertex with 3 edges emanating from it: Two c-edges that are associated with the same curve, and another c-edge associated with a different curve.

An inward corner vertex A c-vertex with 2 c-edges emanating from it, each associated with a different curve.

An outward corner vertex A c-vertex with 4 edges emanating from it: Two consequent c-edges that are associated with two different curves and two ordinary edges.

In particular, we do not handle more than two curves intersecting at one point.

In our algorithm, there is an essential difference between c-vertices and ordinary vertices: While the location $p(v)$ of ordinary vertices of the original control net is determined by the designer, the location of c-vertices is calculated in a preprocessing stage of the algorithm (the exact procedure is described in §4).

Every c-vertex v which is associated with a parameter value u on the curve c , has associated with it a three-dimensional vector $d(v)$, which determines the second partial derivative of the limit surface at the point $c(u)$ in the cross-curve direction (The differentiation is made with respect to a local parameterization that is induced by the subdivision process. The cross-curve direction at a c-vertex v is the limit direction of the ordinary edge emanating for v). We call the value $d(v)$ the *cross-curve second derivative* associated with the vertex v .

Every intersection vertex v has associated with it two three-dimensional vectors $d_1(v)$, $d_2(v)$ that correspond to the two curves c_1 , c_2 that are associated with v . At the intersection between two curves, the surface second derivatives in the two curve directions are determined by the curves, therefore the user does not have control over the cross-curve second derivatives there. Their initialization procedure is described below.

For c-vertices that are not intersection vertices, the vectors $d(v)$ in the initial control net are determined by the designer and they affect the shape of the limit surface. Several ways of initializing the values $d(v)$ are discussed in §5.

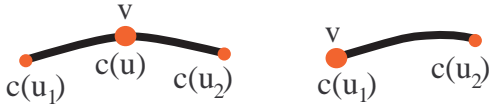

Figure 4: For each c-vertex v that is associated with a curve c we define the second difference $\Delta^2 c(v)$.

Throughout the scheme we apply second difference operators to the given curves. Let v denote a c-vertex associated with a curve c . We define the *second difference of c at v* , denoted by $\Delta^2 c(v)$ as follows (see figure 4): If v is associated with the end of the curve c , then there is a single c-edge emanating from v that is associated with the parameter interval $[u_1, u_2]$ on c . In this case

$$\Delta^2 c(v) = 4c(u_1) - 8c\left(\frac{u_1 + u_2}{2}\right) + 4c(u_2).$$

In case there are two c-edges emanating from v that are associated with the parameter intervals $[u_1, u]$, $[u, u_2]$ on c , we define

$$\Delta^2 c(v) = c(u_1) - 2c(u) + c(u_2).$$

The values $d_1(v)$, $d_2(v)$ at the intersection vertex v which is associated with two curves c_1 and c_2 , are initialized by

$$\begin{aligned} d_1(v) &= \Delta^2 c_1(v) \\ d_2(v) &= \Delta^2 c_2(v). \end{aligned} \quad (1)$$

We say that $d_1(v)$ is the cross-curve second derivative associated with v with respect to the curve c_2 . Similarly, $d_2(v)$ is the cross-curve second derivative associated with v with respect to the curve c_1 .

4 THE COMBINED SCHEME

In the preprocessing stage of our algorithm, we calculate $p(v)$ for every c-vertex of the original control net, according to the following rules: In case v is an intersection vertex which is associated with the point $c(u)$, its location is given by

$$p(v) = c(u) - \frac{d_1(v) + d_2(v)}{6}. \quad (2)$$

In case v is not an intersection vertex, its location is given by

$$p(v) = c(u) - \frac{\Delta^2 c(v) + d(v)}{6}. \quad (3)$$

From (2) and (3) it is clear why the c-vertices do not necessarily lie on the given curves. Notice, for example, in figure 8 how the boundary vertices of the original control net are 'pushed away' from the given boundary curve, due to the term $\Delta^2 c(v)$ in (3).

Each iteration of the subdivision algorithm consists of the following steps: First, Catmull-Clark's scheme as described in §2 is used to calculate the new ordinary vertices. Next, the new c-vertices are calculated (this includes all the boundary vertices). Finally, we perform local 'corrections' on new ordinary vertices that are neighbors of c-vertices.

4.1 Calculation Of Ordinary Vertices

Step 1 of the combined scheme creates the new control net topology, and calculates all the new ordinary vertices, by applying Catmull-Clark's scheme. Since Catmull-Clark's scheme was designed for closed nets, we adapt it a little bit near the surface boundaries, by considering the boundary vertices to have valency 4 when calculating new ordinary vertices that are affected by the boundary vertices.

4.2 Calculation Of C-Vertices

In step 2, the data associated with the new c-vertices is calculated, by the following procedure:

Let e denote a c-edge on the old control net, which corresponds to the parameter interval $[u_0, u_1]$ of the curve c . Let v_0, v_1 denote the vertices of e . We associate the vertex $v(e)$ with $c\left(\frac{u_0 + u_1}{2}\right)$, and we calculate the new cross-curve second derivative for $v(e)$ by the following simple rule:

$$d(v(e)) = \frac{d(v_0) + d(v_1)}{8}. \quad (4)$$

In case v_0 or v_1 are intersection vertices (and therefore, contain two cross-curve second derivative vectors d_1 and d_2), the one taken in (4) should be the cross-curve second derivative with respect to the curve c .

Let v denote a c-vertex on the old control net. We associate $v(v)$ with the same curve and the same parameter value on that curve, as v had. In case v is an intersection vertex, we set $d_1(v(v))$ and $d_2(v(v))$ by (1). Otherwise, the new cross-curve second derivative at $v(v)$ is inherited from v by the following rule:

$$d(v(v)) = \frac{d(v)}{4}. \quad (5)$$

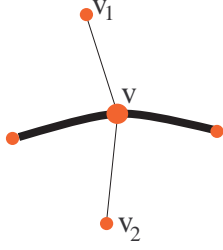

Figure 5: Local corrections near a regular internal c-vertex

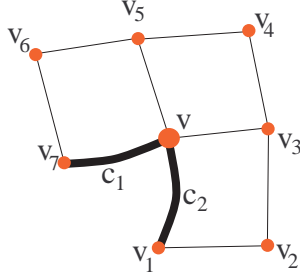

Figure 6: Local corrections near an outward corner.

Step 2 is completed by calculating the location of every c-vertex using (2) and (3).

As the subdivision iterations proceed, the values $d(v)$ and $\Delta^2 C(v)$ decay at a rate of 4^{-k} , where k is the level of subdivision. Therefore the c-vertices converge to points on the curves, which provides the interpolation property (see figure 8).

4.3 Local Corrections Near C-Vertices

Step 3 performs local modifications to the resulting control net near regular internal c-vertices, and near outward corners. Ordinary vertices that are neighbors of regular internal c-vertices are recalculated by the following rule: Let v denote a regular internal c-vertex, and let v_1 and v_2 denote its two neighboring ordinary vertices (see figure 5). Let $p(v_1), p(v_2)$ denote the locations of v_1 and v_2 that resulted from step 1 of the algorithm. Let $p(v)$ denote the location of v that resulted from step 2 of the algorithm. We calculate the corrected locations $\hat{p}(v_1), \hat{p}(v_2)$ by

$$\begin{aligned}\hat{p}(v_1) &= p(v) + \frac{d(v)}{2} + \frac{p(v_1) - p(v_2)}{2}, \\ \hat{p}(v_2) &= p(v) + \frac{d(v)}{2} + \frac{p(v_2) - p(v_1)}{2}.\end{aligned}\quad (6)$$

A different correction rule is applied near outward corner vertices. Let v denote an outward corner vertex, and let v_1, \dots, v_7 denote its neighboring vertices (see figure 6). The vertex v corresponds to the curve c_1 at the parameter value u_1 , and to the curve c_2 at the parameter value u_2 . In particular, $c_1(u_1) = c_2(u_2)$.

Let $p(v), p(v_1), \dots, p(v_7)$ denote the locations of v, v_1, \dots, v_7 that resulted from steps 1 and 2 of the algorithm. Let a be the vector $a = \frac{1}{4}(1, -1, -1, 2, -1, -1, 1)$. We calculate the corrected

locations for v_2, \dots, v_6 by the following rules:

$$\begin{aligned}t &= \sum_{i=1}^7 a_i p(v_i), \\ \hat{p}(v_3) &= \frac{1}{3}p(v_3) + \frac{2}{3}(2p(v) - p(v_7) + \Delta^2 c_1(v)), \\ \hat{p}(v_5) &= \frac{1}{3}p(v_5) + \frac{2}{3}(2p(v) - p(v_1) + \Delta^2 c_2(v)). \\ \hat{p}(v_2) &= \frac{1}{3}p(v_2) + \frac{2}{3}(\hat{p}(v_3) + p(v_1) - p(v) - t) \\ \hat{p}(v_6) &= \frac{1}{3}p(v_6) + \frac{2}{3}(\hat{p}(v_5) + p(v_7) - p(v) - t) \\ \hat{p}(v_4) &= \frac{1}{3}p(v_4) + \frac{2}{3}(\hat{p}(v_5) + \hat{p}(v_3) - p(v) + t)\end{aligned}\quad (7)$$

There are cases when a single vertex has more than one corrected location, for example an ordinary vertex which is a neighbor of several c-vertices. In these cases we calculate all the corrected locations for such a vertex, using (6) or (7) and define the new location of that vertex to be the arithmetic mean of all the corrected locations. Situations like these occur frequently at the first level of subdivision. The only possibility for a vertex to have more than one corrected location after the first subdivision iteration, is near intersection vertices; The vertex always has two corrected locations, and its new location is taken to be their arithmetic mean.

5 DISCUSSION

The cross-curve second derivatives $d(v)$ of the original control net as determined by the designer, play an important role in determining the shape of the limit surface. As part of constructing the initial control net, a 3D vector $d(v)$ should be initialized by the designer, for every *regular internal c-vertex* and for every *regular boundary c-vertex*.

In case the initial control net contains only intersection vertices (such as the control net in figure 1), (1) determines all the cross-curve second derivatives. Otherwise they can be initialized by any kind of heuristic method.

We suggest the following heuristic approach to initialize $d(v)$ in case v is a regular internal c-vertex: Let v be associated with the curve c at the parameter value u , and let v_1, v_2 denote the two ordinary vertices that are neighbors of v (see figure 5). It seems reasonable to calculate $d(v)$ such that

$$p(v_1) + p(v_2) - 2p(v) = d(v),$$

because we know that this relation holds in the limit. Since $p(v)$ itself depends on $d(v)$ according to (3), we get the following formula for $d(v)$:

$$d(v) = \frac{3}{2}(p(v_1) + p(v_2)) - 3c(u) + \frac{1}{2}\Delta^2 c(v).\quad (8)$$

In case v is a regular boundary c-vertex, which lies between two boundary intersection vertices v_1, v_2 (see figure 7), one should probably consider the second derivatives at v_1, v_2 when determining $d(v)$. The following heuristic rule can be used:

$$d(v) = \frac{\Delta^2 c_1(v) + \Delta^2 c_2(v)}{2},\quad (9)$$

where v_1, v_2 are associated with $c_1(u_1)$ and $c_2(u_2)$ respectively.

There are many cases when the choice $d(v) = 0$ generates the nicest shapes when v is a regular boundary c-vertex. Recall that the natural interpolating cubic spline has zero second derivative at its ends.

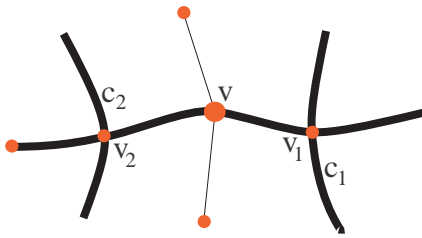

Figure 7: A regular boundary c-vertex between two boundary intersection vertices

Other ways of determining $d(v)$ may employ variational principles. One can choose $d(v)$ such as to minimize a certain fairness measure of the entire surface.

6 CONCLUSIONS

With *combined subdivision schemes* that extend the notion of the known subdivision schemes, it is simple to generate surfaces of arbitrary topological type that interpolate nets of curves given in any parametric representation. The scheme presented in this paper is easy to implement and generates nice looking and almost G^2 surfaces, provided that the given curves are C^2 . These surfaces are suitable for machining purposes since they have bounded curvature.

The current algorithm is restricted to nets of curves where no more than two curves intersect at one point, which is a considerable restriction for many applications. However, we believe that the basic idea of applying subdivision rules that explicitly involve the given curve data, and the general theory of combined subdivision schemes can be extended to handle nets where three or more curves intersect at one point, as well as nets with irregular c-vertices.

The proposed scheme can work even if the given curves are not C^2 , since it only uses point-wise evaluations. In case the curves are C^1 , for example, the limit surface will be only G^1 . Moreover, in case a given curve has a local 'fault', and otherwise it is C^2 , the local 'fault' will have only a local effect on the limit surface.

Creases in the limit surface can be introduced along a given curve by avoiding the corrections made to vertices near that curve in step 3 of the subdivision. This causes the curve to act as a boundary curve to the surface on both sides of the curve.

Concerning the computation time, notice that most of the computational work in each iteration is spent in the first step of the subdivision iteration, namely, in applying Catmull-Clark's scheme. The local corrections are very simple, and apply only near c-vertices (whose number, after a few iterations, is much lower than that of the ordinary vertices).

Using the analysis tools we have developed in [7, 8], other combined subdivision schemes can be constructed to perform other tasks, such as the generation of surfaces that satisfy certain boundary conditions, including tangent plane conditions [10], and even curvature continuity conditions.

Figures 8-19 show several surfaces created by our algorithm.

Acknowledgement

This work is sponsored by the Israeli Ministry of Science. I thank Nira Dyn for her guidance and many helpful comments, and Peter Schröder for his constant encouragement and advice.

References

- [1] E. Catmull and J. Clark. Recursively generated b-spline surfaces on arbitrary topological meshes. *Computer Aided Design*, 10:350–355, 1978.
- [2] T. DeRose, M. Kass, and T. Truong. Subdivision surfaces in character animation. In *SIGGRAPH 98 Conference Proceedings*, Annual Conference Series, pages 85–94. ACM SIGGRAPH, 1998.
- [3] D. Doo and M. Sabin. Behaviour of recursive division surface near extraordinary points. *Computer Aided Design*, 10:356–360, 1978.
- [4] N. Dyn, J. A. Greogory, and D. Levin. A butterfly subdivision scheme for surface interpolation with tension control. *ACM Transactions on Graphics*, 9:160–169, 1990.
- [5] M. Halstead, M. Kass, and T. DeRose. Efficient, fair interpolation using catmull-clark sutfaces. In *SIGGRAPH 93 Conference Proceedings*, Annual Conference Series, pages 35–44. ACM SIGGRAPH, 1993.
- [6] L. Kobbelt, T. Hesse, H. Prautzsch, and K. Schweizerhof. Interpolatory subdivision on open quadrilateral nets with arbitrary topology. *Computer Graphics Forum*, 15:409–420, 1996. Eurographics '96 issue.
- [7] A. Levin. Analysis of combined subdivision schemes 1. in preparation, available on the web at <http://www.math.tau.ac.il/~adilev>, 1999.
- [8] A. Levin. Analysis of combined subdivision schemes 2. in preparation, available on the web at <http://www.math.tau.ac.il/~adilev>, 1999.
- [9] A. Levin. Analysis of combined subdivision schemes for the interpoation of curves. *SIGGRAPH'99 CDROM Proceedings*, 1999.
- [10] A. Levin. Combined subdivision schemes for the design of surfaces satisfying boundary conditions. To appear in *CAGD*, 1999.
- [11] C. Loop. Smooth spline surfaces based on triangles. Master's thesis, University of Utah, Department of Mathematics, 1987.
- [12] A. H. Nasri. Curve interpolation in recursively generated b-spline surfaces over arbitrary topology. *Computer Aided Geometric Design*, 14:No 1, 1997.
- [13] A. H. Nasri. Interpolation of open curves by recursive subdivision surface. In T. Goodman and R. Martin, editors, *The Mathematics of Surfaces VII*, pages 173–188. Information Geometers, 1997.
- [14] M. Sabin. Cubic recursive division with bounded curvature. In P. J. Laurent, A. le Mehaute, and L. L. Schumaker, editors, *Curves and Surfaces*, pages 411–414. Academic Press, 1991.
- [15] J. Schweitzer. *Analysis and Applications of Subdivision Surfaces*. PhD thesis, University of Washington, Seattle, 1996.
- [16] D. J. T. Storry and A. A. Ball. Design of an n-sided surface patch. *Computer Aided Geometric Design*, 6:111–120, 1989.
- [17] G. Taubin. A signal processing approach to fair surface design. In Robert Cook, editor, *SIGGRAPH 95 Conference Proceedings*, Annual Conference Series, pages 351–358. ACM SIGGRAPH, Addison Wesley, August 1995. held in Los Angeles, California, 06-11 August 1995.

[18] D. Zorin, P. Schröder, and W. Sweldens. Interpolating subdivision for meshes with arbitrary topology. *Computer Graphics Proceedings (SIGGRAPH 96)*, pages 189–192, 1996.

Appendix

We present the procedure for calculating the weights mentioned in §2, as formulated by Sabin in [14].

Let $n > 2$ denote a vertex valency. Let $k := \cos(\pi/n)$. Let x be the unique real root of

$$x^3 + (4k^2 - 3)x - 2k = 0,$$

satisfying $x > 1$. Then

$$\begin{aligned} W_n &= x^2 + 2kx - 3, \\ \alpha_n &= 1, \\ \gamma_n &= \frac{kx + 2k^2 - 1}{x^2(kx + 1)}, \\ \beta_n &= -\gamma_n. \end{aligned} \tag{10}$$

n	W_n	γ_n
3	1.23606797749979...	0.06524758424985...
4	1	0.25
5	0.71850240323974...	0.40198344690335...
6	0.52233339335931...	0.52342327689253...
7	0.39184256502794...	0.61703187134796...

Table 1: The weights used in Sabin’s variant of Catmull-Clark’s subdivision scheme

The original paper by Sabin [14] contains a mistake: the formulas for the parameters α, β and γ that appear in §4 there, are $\beta := 1, \gamma := -\alpha$.

The weights W_n and γ_n for $n = 3, \dots, 7$ are given in table 1.

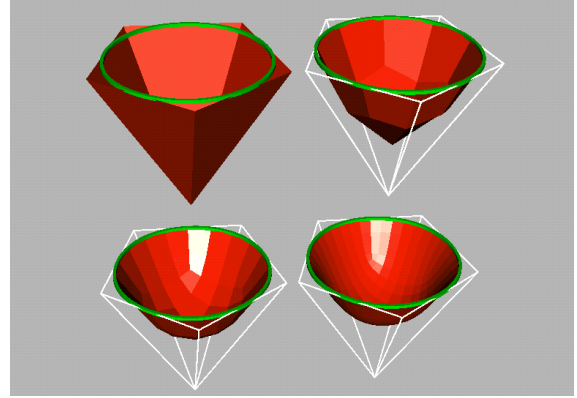

Figure 8: Three iterations of the algorithm. We have chosen $d(v) = 0$ for every c -vertex v , which results in parabolic points on the surface boundary.

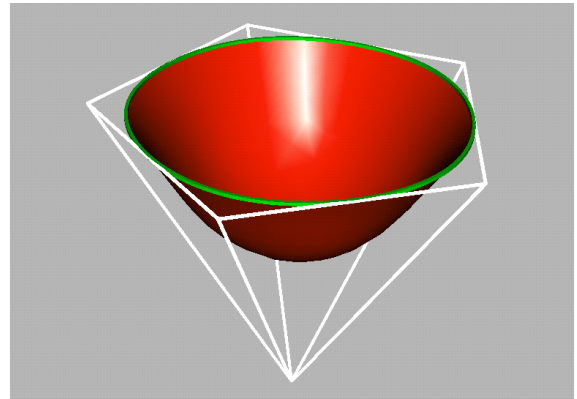

Figure 9: The limit surface of the iterations shown in figure 8

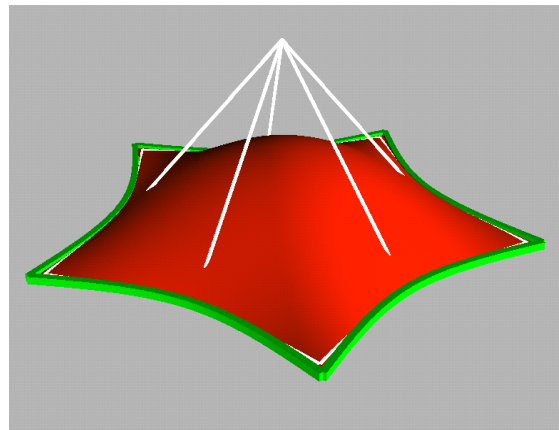

Figure 10: A 5-sided surface generated from a simple control net, with zero $d(v)$ for all c -vertices v . Our algorithm easily fills arbitrary N -sided patches.

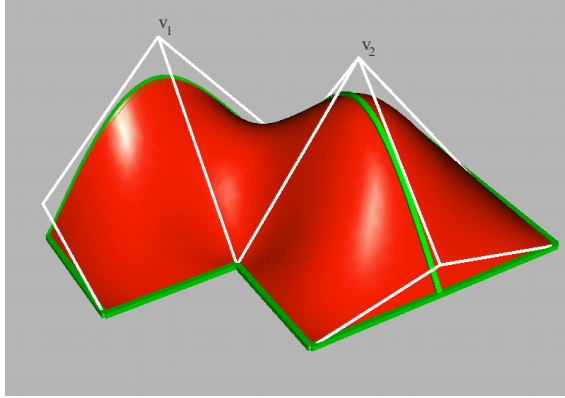

Figure 11: A surface with an outward corner. We used (8) to calculate $d(v_2)$, and set $d(v_1) = 0$.

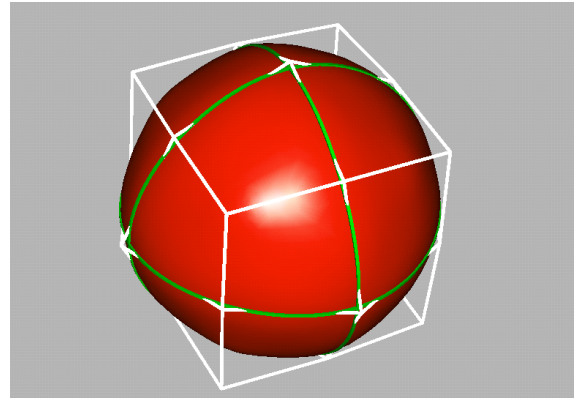

Figure 14: A closed surface. The cross curve second derivatives for regular internal c-vertices were calculated using (9).

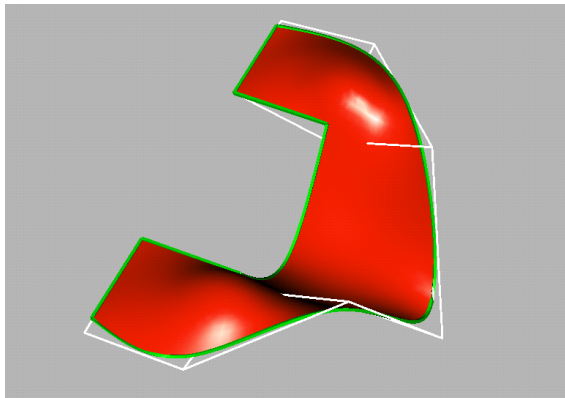

Figure 12: A surface with non smooth boundary curves, and zero cross-curve second derivatives

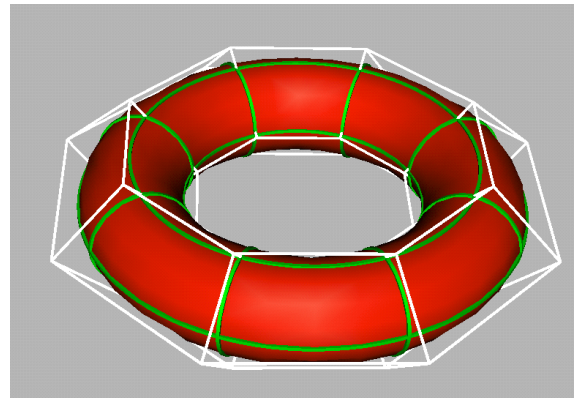

Figure 15: A Torus-like surface, from a net of circles.

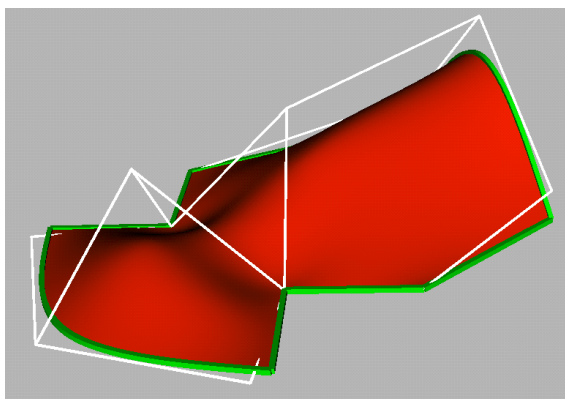

Figure 13: A surface with non smooth boundary curves, and zero cross-curve second derivatives

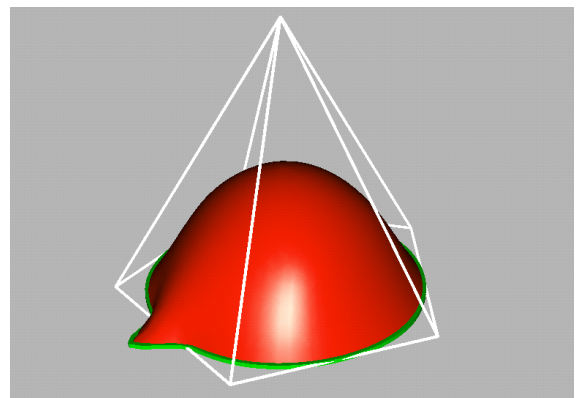

Figure 16: Introducing small perturbations to the given curves results in small and local perturbations of the limit surface. Notice that the original control net does not contain the information of the small perturbations. These come directly from the data of the curves.

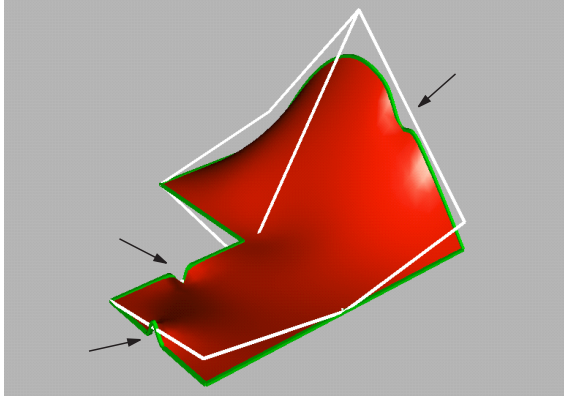

Figure 17: Small perturbations to the given curves result in small and local deformation of the limit surface.

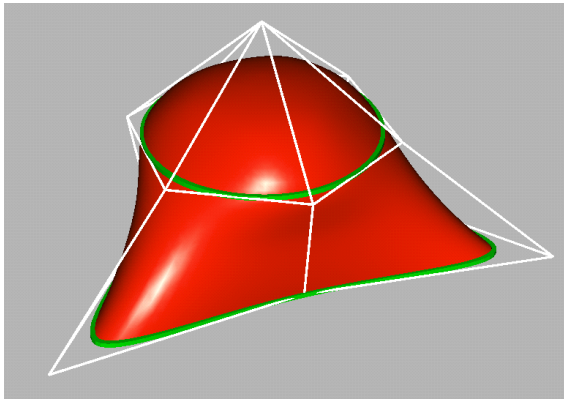

Figure 18: A surface constructed from two given sections. The cross curve second derivatives for the regular internal c-vertices were calculated using (8). For boundary vertices, we took $d(v) = 0$.

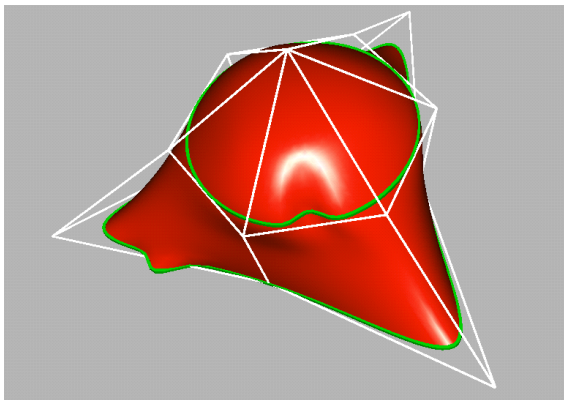

Figure 19: the same surface as in figure 18 after introducing small perturbations in the section curves.

Chapter 7

Interpolatory Subdivision for Quad Meshes

Author: Leif Kobbelt

Interpolatory Subdivision for Quad-Meshes

A simple interpolatory subdivision scheme for quadrilateral nets with arbitrary topology is presented which generates C^1 surfaces in the limit. The scheme satisfies important requirements for practical applications in computer graphics and engineering. These requirements include the necessity to generate smooth surfaces with local creases and cusps. The scheme can be applied to open nets in which case it generates boundary curves that allow a C^0 -join of several subdivision patches. Due to the local support of the scheme, adaptive refinement strategies can be applied. We present a simple device to preserve the consistency of such adaptively refined nets.

The original paper has been published in:

L. Kobbelt
Interpolatory Subdivision on Open Quadrilateral Nets with Arbitrary Topology,
 Computer Graphics Forum 15 (1996), Eu-
 rographics '96 issue, pp. 409–420

3.1 Introduction

The problem we address in this paper is the generation of smooth interpolating surfaces of arbitrary topological type in the context of practical applications. Such applications range from the design of free-form surfaces and scattered data interpolation to high quality rendering and mesh generation, e.g., in finite element analysis. The standard set-up for this problem is usually given in a form equivalent to the following:

A net $N = (V, F)$ representing the input is to be mapped to a refined net $N' = (V', F')$ which is required to be a sufficiently close approximation of a smooth surface. In this notation the sets V and V' contain the data points $\mathbf{p}_i, \mathbf{p}'_i \in \mathbb{R}^3$ of the input or output respectively. The sets F and F' represent the topological information of the nets. The elements of F and F' are finite sequences of points $s_k \subset V$ or $s'_k \subset V'$ each of which enumerates the corners of one not necessarily planar face of a net.

If all elements $s_k \in F$ have length four then N is called a quadrilateral net. To achieve interpolation of the given data, $V \subset V'$ is required. Due to the geometric background of the problem we assume N to be feasible, i.e., at each point \mathbf{p}_i there exists a plane T_i such that the projection of the faces meeting at \mathbf{p}_i onto T_i is injective. A net is closed if every edge is part of exactly two faces. In open nets, boundary edges occur which belong to one face only.

There are two major 'schools' for computing N' from a given N . The first or classic way of doing this is to explicitly find a collection of local (piecewise polynomial) parametrizations (patches) corresponding to the faces of N . If these patches smoothly join at common boundaries they form an overall smooth patch complex. The net N' is then obtained by sampling each patch on a sufficiently fine grid. The most important step in this approach is to find smoothly joining patches which represent a surface of arbitrary topology. A lot of work has been done in this field, e.g., [16], [15], [17] ...

Another way to generate N' is to define a refinement operator \mathcal{S} which directly maps nets to nets without constructing an explicit parametrization of a surface. Such an operator performs both, a topological refinement of the net by splitting the faces and a geometric refinement by determining the position of the new points in order to reduce the angles between adjacent faces (smoothing). By iteratively applying \mathcal{S} one produces a sequence of nets N_i with $N_0 = N$ and $N_{i+1} = \mathcal{S}N_i$. If \mathcal{S} has certain properties then the sequence $\mathcal{S}^i N$ converges to a smooth limiting surface and we can set $N' := \mathcal{S}^k N$ for some sufficiently large k . Algorithms of this kind are proposed in [2], [4], [14], [7], [10], and [11]. All these schemes

are either non-interpolatory or defined on triangular nets which is not appropriate for some engineering applications.

The scheme which we present here is a stationary refinement scheme [9], [3], i.e., the rules to compute the positions of the new points use simple affine combinations of points from the unrefined net. The term stationary implies that these rules are the same on every refinement level. They are derived from a modification of the well-known four-point scheme [6]. This scheme refines polygons by $\mathcal{S}: (\mathbf{p}_i) \mapsto (\mathbf{p}'_i)$ with

$$\begin{aligned} \mathbf{p}'_{2i} &:= \mathbf{p}_i \\ \mathbf{p}'_{2i+1} &:= \frac{8+\omega}{16}(\mathbf{p}_i + \mathbf{p}_{i+1}) - \frac{\omega}{16}(\mathbf{p}_{i-1} + \mathbf{p}_{i+2}) \end{aligned} \quad (11)$$

where $0 < \omega < 2(\sqrt{5} - 1)$ is sufficient to ensure convergence to a smooth limiting curve [8]. The standard value is $\omega = 1$ for which the scheme has cubic precision. In order to minimize the number of special cases, we restrict ourselves to the refinement of quadrilateral nets. The faces are split as shown in Fig. 10 and hence, to complete the definition of the operator \mathcal{S} , we need rules for new points corresponding to edges and/or faces of the unrefined net. To generalize the algorithm for interpolating arbitrary nets, a precomputing step is needed (cf. Sect. 3.2).

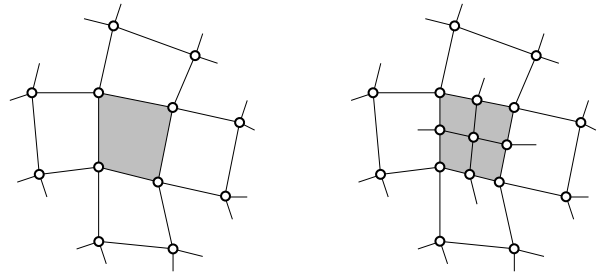

Figure 10: The refinement operator splits one quadrilateral face into four. The new vertices can be associated with the edges and faces of the unrefined net. All new vertices have valency four.

The major advantages that this scheme offers, are that it has the interpolation property and works on quadrilateral nets. This seems to be most appropriate for engineering applications (compared to non-interpolatory schemes or triangular nets), e.g., in finite element analysis since quadrilateral (bilinear) elements are less stiff than triangular (linear) elements [19]. The scheme provides the maximum flexibility since it can be applied to open nets with arbitrary topology. It produces smooth surfaces and yields the possibility to generate local creases and cusps. Since the support of the scheme is local, adaptive refinement strategies can be applied. We present a technique to keep adaptively refined nets C^0 -consistent (cf. Sect. 3.6) and shortly describe an appropriate data structure for the implementation of the algorithm.

3.2 Precomputing: Conversion to Quadrilateral Nets

It is a fairly simple task to convert a given arbitrary net \tilde{N} into a quadrilateral net N . One straightforward solution is to apply one single Catmull-Clark-type split \mathcal{C} [2] to every face (cf. Fig. 11). This split operation divides every n -sided face into n quadrilaterals and needs the position of newly computed face-points and edge-points to be well-defined. The vertices of \tilde{N} remain unchanged.

The number of faces in the modified net N equals the sum of the lengths of all sequences $s_k \in \tilde{F}$.

The number of faces in the quadrilateralized net N can be reduced by half if the net is closed, by not applying \mathcal{C} but rather its (topological) square root $\sqrt{\mathcal{C}}$, i.e., a refinement operator whose double application is equivalent to one application of \mathcal{C} (cf. Fig. 11). For this split, only new *face-points* have to be computed. For open nets, the $\sqrt{\mathcal{C}}$ -split modifies the boundary polygon in a non-intuitive way. Hence, one would have to handle several special cases with boundary triangles if one is interested in a well-behaved boundary curve of the resulting surface.

3.3 Subdivision Rules for Closed Nets with Arbitrary Topology

The topological structure of any quadrilateral net after several applications of a uniform refinement operator consists of large regular regions with isolated singularities which correspond to the non-regular vertices of the initial net (cf. Fig. 12). By *topological regularity* we mean a tensor product structure with four faces meeting at every vertex. The natural way to define refinement operators for quadrilateral nets is therefore to modify a tensor product scheme such that special rules for the vicinity of non-regular vertices are found. In this paper we will use the interpolatory four-point scheme [6] in its tensor product version as the basis for the modification.

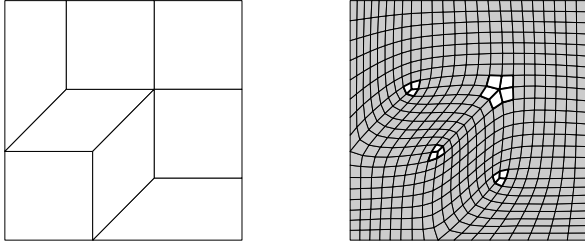

Figure 12: Isolated singularities in the refined net.

Consider a portion of a regular quadrilateral net with vertices $\mathbf{p}_{i,j}$. The vertices can be indexed locally such that each face is represented by a sequence $s_{i,j} = \{\mathbf{p}_{i,j}, \mathbf{p}_{i+1,j}, \mathbf{p}_{i+1,j+1}, \mathbf{p}_{i,j+1}\}$. The points $\mathbf{p}'_{i,j}$ of the refined net can be classified into three disjunct groups. The *vertex-points* $\mathbf{p}'_{2i,2j} := \mathbf{p}_{i,j}$ are fixed due to the interpolation requirement. The *edge-points* $\mathbf{p}'_{2i+1,2j}$ and $\mathbf{p}'_{2j,2i+1}$ are computed by applying the four-point rule (11) in the corresponding grid direction, e.g.,

$$\mathbf{p}'_{2i+1,2j} := \frac{8+\omega}{16}(\mathbf{p}_{i,j} + \mathbf{p}_{i+1,j}) - \frac{\omega}{16}(\mathbf{p}_{i-1,j} + \mathbf{p}_{i+2,j}). \quad (12)$$

Finally, the *face-points* $\mathbf{p}'_{2i+1,2j+1}$ are computed by applying the four-point rule to either four consecutive edge-points $\mathbf{p}'_{2i+1,2j-2}, \dots, \mathbf{p}'_{2i+1,2j+4}$ or to $\mathbf{p}'_{2i-2,2j+1}, \dots, \mathbf{p}'_{2i+4,2j+1}$. The resulting weight coefficient masks for these rules are shown in Fig. 13. The symmetry of the *face-mask* proves the equivalence of both alternatives to compute the face-points. From the differentiability of the limiting curves generated by the four-point scheme, the smoothness of the limiting surfaces generated by infinitely refining a regular quadrilateral net, follows immediately. This is a simple tensor product argument.

For the refinement of irregular quadrilateral nets, i.e., nets which include some vertices where other than four faces meet, a consistent indexing which allows the application of the above rules is impossible. If other than four edges meet at one vertex, it is not clear how to choose the four points to which one can apply the above rule

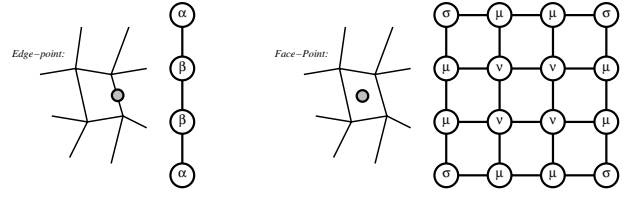

Figure 13: Subdivision masks for regular regions with $\alpha = -\frac{\omega}{16}$, $\beta = \frac{8+\omega}{16}$ and $\sigma = \alpha^2, \mu = \alpha\beta, \nu = \beta^2$.

for computing the edge-points. However, once all the edge-points are known, there always are exactly two possibilities to choose four consecutive edge-points when computing a certain face-point since the net is quadrilateral. It is an important property of tensor product schemes on regular nets that both possibilities lead to the same result (commuting univariant refinement operators). In order to modify the tensor product scheme as little as possible while generalizing it to be applicable for nets with arbitrary topology, we want to conserve this property. Hence, we will propose a subdivision scheme which only needs *one* additional rule: the one for computing edge-points corresponding to edges adjacent to a non-regular vertex. All other edge-points and all face-points are computed by the application of the original four-point scheme and the additional rule will be such that both possibilities for the face-points yield the same result.

We use the notation of Fig. 14 for points in the neighborhood of a singular vertex \mathbf{p} . The index i is taken to be *modulo* n where n is the number of edges meeting at \mathbf{p} . Applying the original four-point rule wherever possible leaves only the points \mathbf{x}_i and \mathbf{y}_i undefined. If we require that both possible ways to compute \mathbf{y}_i by applying the standard four-point rule to succeeding edge-points lead to the same result, we get a dependence relating \mathbf{x}_{i+1} to \mathbf{x}_i

$$\mathbf{x}_{i+1} = \mathbf{x}_i + \frac{w}{8}(\mathbf{h}_i - \mathbf{h}_{i+1}) + \frac{w^2}{8(4+w)}(\mathbf{k}_{i-2} - \mathbf{k}_{i+2}) + \frac{w}{8}(\mathbf{l}_{i+2} - \mathbf{l}_{i-1}) + \frac{4+w}{8}(\mathbf{l}_{i+1} - \mathbf{l}_i),$$

which can be considered as compatibility condition. In the regular case, this condition is satisfied for any tensor product rule. The compatibility uniquely defines the cyclic differences $\Delta \mathbf{x}_i = \mathbf{x}_{i+1} - \mathbf{x}_i$ which sum to zero (*telescoping sums*). Hence, there always exists a solution and even one degree of freedom is left for the definition of the \mathbf{x}_i .

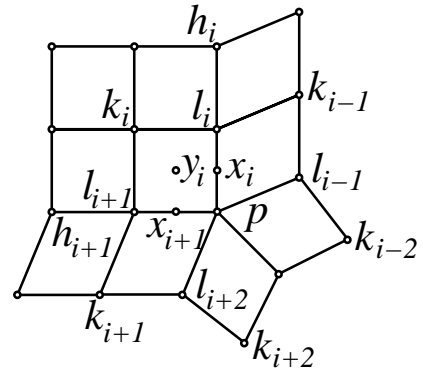

Figure 14: Notation for vertices around a singular vertex P .

The points \mathbf{x}_i will be computed by rotated versions of the same subdivision mask. Thus, the vicinity of \mathbf{p} will become more and more symmetric while refinement proceeds. Hence, the distance

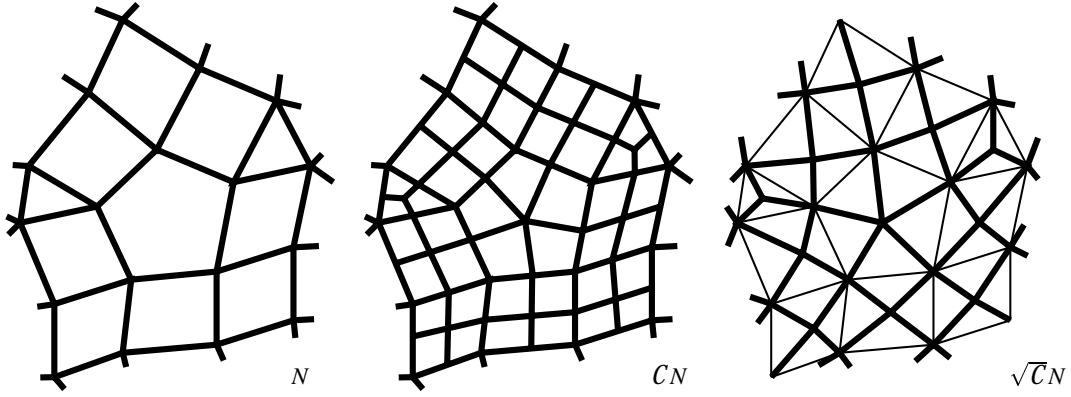

Figure 11: Transformation of an arbitrary net \tilde{N} into a quadrilateral net N by one Catmull-Clark-split C (middle) or by its square root (right, for closed nets).

between \mathbf{p} and the center of gravity of the \mathbf{x}_i will be a good measure for the roughness of the net near \mathbf{p} and the rate by which this distance tends to zero can be understood as the ‘smoothing rate’. The center of gravity in the regular ($n = 4$) case is:

$$\frac{1}{n} \sum_{i=0}^{n-1} \mathbf{x}_i = \frac{4+w}{8} \mathbf{p} + \frac{1}{2n} \sum_{i=0}^{n-1} \mathbf{l}_i - \frac{w}{8n} \sum_{i=0}^{n-1} \mathbf{h}_i. \quad (13)$$

In the non-regular case, we have

$$\frac{1}{n} \sum_{i=0}^{n-1} \mathbf{x}_i = \mathbf{x}_j + \frac{1}{n} \sum_{i=0}^{n-2} (n-1-i) \Delta \mathbf{x}_{i+j}, \quad (14)$$

$$j \in \{0, \dots, n-1\}.$$

Combining common terms in the telescoping sum and equating the right hand sides of (13) and (14) leads to

$$\mathbf{x}_j = -\frac{w}{8} \mathbf{h}_j + \frac{4+w}{8} \mathbf{l}_j + \frac{4+w}{8} \mathbf{p} - \frac{w}{8} \mathbf{v}_j, \quad (15)$$

where we define the *virtual point*

$$\mathbf{v}_j := \frac{4}{n} \sum_{i=0}^{n-1} \mathbf{l}_i - (\mathbf{l}_{j-1} + \mathbf{l}_j + \mathbf{l}_{j+1}) + \frac{w}{4+w} (\mathbf{k}_{j-2} + \mathbf{k}_{j-1} + \mathbf{k}_j + \mathbf{k}_{j+1}) - \frac{4w}{(4+w)n} \sum_{i=0}^{n-1} \mathbf{k}_i. \quad (16)$$

Hence, the \mathbf{x}_j can be computed by applying (11) to the four points $\mathbf{h}_j, \mathbf{l}_j, \mathbf{p}$ and \mathbf{v}_j . The formula also holds in the case $n = 4$ where $\mathbf{v}_j = \mathbf{l}_{j+2}$. Such a virtual point \mathbf{v}_j is defined for every edge and both of its endpoints. Hence to refine an edge which connects two singular vertices \mathbf{p}_1 and \mathbf{p}_2 , we first compute the two virtual points \mathbf{v}_1 and \mathbf{v}_2 and then apply (11) to $\mathbf{v}_1, \mathbf{p}_1, \mathbf{p}_2$ and \mathbf{v}_2 . If all edge-points \mathbf{x}_j are known, the refinement operation can be completed by computing the face-points \mathbf{y}_j . These are well defined since the auxiliary edge-point rule is constructed such that both possible ways lead to the same result.

3.4 Convergence Analysis

The subdivision scheme proposed in the last section is a stationary scheme and thus the convergence criteria of [1] and [18] can be

applied. In the regular regions of the net (which enlarge during refinement), the smoothness of the limiting surface immediately follows from the smoothness of the curves generated by the univariate four-point scheme. Hence to complete the convergence analysis, it is sufficient to look at the vicinities of the finitely many isolated singular vertices (cf. Fig. 12).

Let $\mathbf{p}_0, \dots, \mathbf{p}_k$ be the points from a fixed neighborhood of the singular vertex \mathbf{p}_0 . The size of the considered neighborhood depends on the support of the underlying tensor product scheme and contains 5 ‘rings’ of faces around \mathbf{p}_0 in our case. The collection of all rules to compute the new points $\mathbf{p}'_0, \dots, \mathbf{p}'_k$ of the same ‘scaled’ (5-layer-) neighborhood of $\mathbf{p}_0 = \mathbf{p}'_0$ in the refined net can be represented by a block-circulant matrix \mathbf{A} such that $(\mathbf{p}'_i)_j = \mathbf{A}(\mathbf{p}_i)_j$. This matrix is called the *refinement matrix*. After [1] and [18] the convergence analysis can be reduced to the analysis of the eigenstructure of \mathbf{A} . For the limiting surface to have a unique tangent plane at \mathbf{p}_0 it is sufficient that the leading eigenvalues of \mathbf{A} satisfy

$$\lambda_1 = 1, \quad 1 > \lambda_2 = \lambda_3, \quad |\lambda_2| > |\lambda_i|, \forall i \geq 4.$$

Table 2 shows these eigenvalues of the refinement matrix \mathbf{A} for vertices with n adjacent edges in the standard case $\omega = 1$. The computation of the spectrum can be done by exploiting the block-circulant structure of \mathbf{A} . We omit the details here, because the dimension of \mathbf{A} is $k \times k$ with $k = 30n + 1$.

n	λ_1	λ_2	λ_3	$\lambda_{i>4} \leq$
3	1.0	0.42633	0.42633	0.25
4	1.0	0.5	0.5	0.25
5	1.0	0.53794	0.53794	0.36193
6	1.0	0.55968	0.55968	0.42633
7	1.0	0.5732	0.5732	0.46972
8	1.0	0.58213	0.58213	0.5
9	1.0	0.58834	0.58834	0.52180

Table 2: Leading eigenvalues of the subdivision matrix

In addition to a uniquely defined tangent plane we also have to have local injectivity in order to guarantee the regularity of the surface. This can be checked by looking at the natural parametrization of the surface at \mathbf{p}_0 which is spanned by the eigenvectors of \mathbf{A} corresponding to the subdominant eigenvalues λ_2 and λ_3 . The injectivity of this parametrization is a sufficient condition. The details can be found in [18]. Fig. 15 shows meshes of ‘isolines’ of these characteristic maps which are well-behaved.

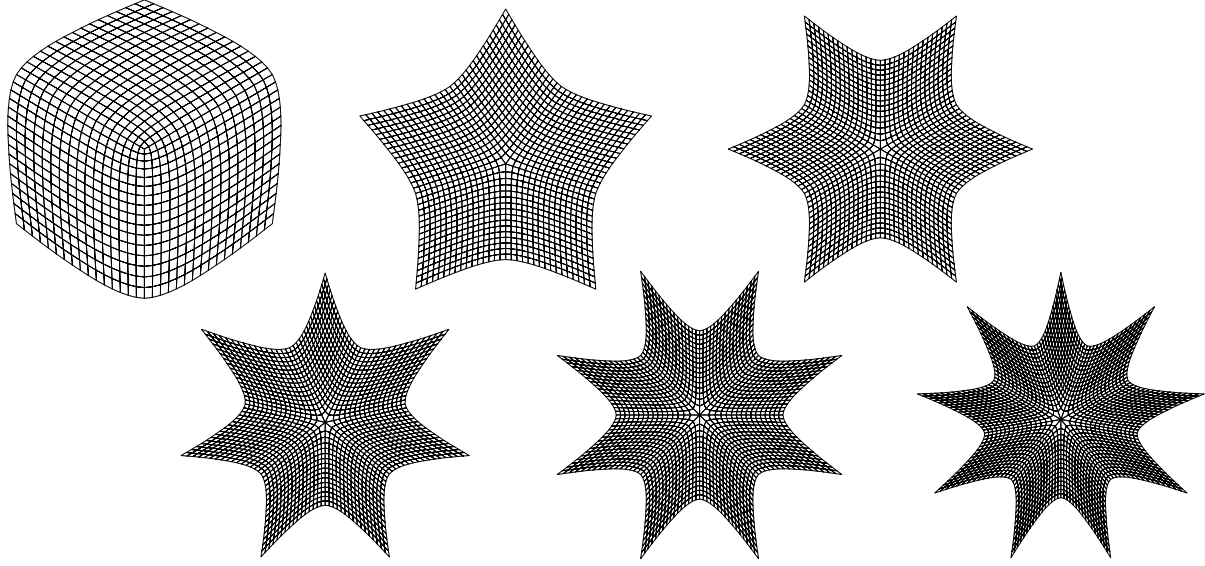

Figure 15: Sketch of the characteristic maps in the neighborhood of singular vertices with $n = 3, 5, \dots, 9$.

3.5 Boundary Curves

If a subdivision scheme is supposed to be used in practical modeling or reconstruction applications, it must provide features that allow the definition of creases and cusps [12]. These requirements can be satisfied if the scheme includes special rules for the refinement of *open* nets which yield well-behaved boundary curves that interpolate the boundary polygons of the given net. Having such a scheme, creases can be modeled by joining two separate subdivision surfaces along a common boundary curve and cusps result from a topological hole in the initial net which geometrically shrinks to a single point, i.e., a face $s = \{\mathbf{p}_1, \dots, \mathbf{p}_n\}$ of a given net is deleted to generate a hole and its vertices are moved to the same location $\mathbf{p}_i = \mathbf{p}$ (cf. Fig. 16).

To allow a C^0 -join between two subdivision patches whose initially given nets have a common boundary polygon, it is necessary that their limiting boundary curves only depend on these common points, i.e., they must not depend on any interior point. For our scheme, we achieve this by simply applying the original univariate four-point rule to boundary polygons. Thus, the boundary curve of the limiting surface is exactly the four-point curve which is defined by the initial boundary polygon. Further, it is necessary to not only generate *smooth* boundary curves but rather to allow *piecewise smooth* boundary curves, e.g., in cases where more than two subdivision patches meet at a common point. In this case we have to cut the boundary polygon into several segments by marking some vertices on the boundary as being *corner vertices*. Each segment between two corner vertices is then treated separately as an open polygon.

When dealing with open polygons, it is not possible to refine the first or the last edge by the original four-point scheme since rule (11) requires a well-defined 2-neighborhood. Therefore, we have to find another rule for the point \mathbf{p}_1^{m+1} which subdivides the edge $\overline{\mathbf{p}_0^m \mathbf{p}_1^m}$. We define an *extrapolated* point $\mathbf{p}_{-1}^m := 2\mathbf{p}_0^m - \mathbf{p}_1^m$. The point \mathbf{p}_1^{m+1} then results from the application of (11) to the sub-polygon $\mathbf{p}_{-1}^m, \mathbf{p}_0^m, \mathbf{p}_1^m, \mathbf{p}_2^m$. Obviously, this additional rule can be expressed as a stationary linear combination of points from the non-extrapolated open polygon:

$$\mathbf{p}_1^{m+1} := \frac{8-w}{16} \mathbf{p}_0^m + \frac{8+2w}{16} \mathbf{p}_1^m - \frac{w}{16} \mathbf{p}_2^m \quad (17)$$

The rule to compute the point \mathbf{p}_{2n-1}^{m+1} subdividing the last edge

$\overline{\mathbf{p}_{n-1}^m \mathbf{p}_n^m}$ is defined analogously.

This modification of the original scheme does not affect the convergence to a continuously differentiable limit, because the estimates for the contraction rate of the maximum second forward difference used in the convergence proof of [6] remain valid. This is obvious since the extrapolation only adds the zero component $\Delta^2 p_{-1}^m$ to the sequence of second order forward differences. The main convergence criterion of [13] also applies.

It remains to define refinement rules for inner edges of the net which have one endpoint on the boundary and for faces including at least one boundary vertex. To obtain these rules we use the same heuristic as in the univariate case. We extrapolate the unrefined net over every boundary edge to get an additional layer of faces. When computing the edge- and face-points refining the original net by the rules from Sect. 3.3, these additional points can be used. To complete the refinement step, the extrapolated faces are finally deleted.

Let $\mathbf{q}_1, \dots, \mathbf{q}_r$ be the *inner* points of the net which are connected to the boundary point \mathbf{p} then the extrapolated point will be

$$\mathbf{p}^* := 2\mathbf{p} - \frac{1}{r} \sum_{i=1}^r \mathbf{q}_i.$$

If the boundary point \mathbf{p} belongs to the face $s = \{\mathbf{p}, \mathbf{q}, \mathbf{u}, \mathbf{v}\}$ and is connected to any inner vertex then we define $\mathbf{p}^* := 2\mathbf{p} - \mathbf{u}$. For every boundary edge $\overline{\mathbf{p}\mathbf{q}}$ we add the extrapolated face $s^* = \{\mathbf{p}, \mathbf{q}, \mathbf{q}^*, \mathbf{p}^*\}$.

Again, the tangent-plane continuity of the resulting limiting surface can be proved by the sufficient criteria of [1] and [18]. This is obvious since for a fixed number of interior edges adjacent to some boundary vertex \mathbf{p} , the refinement of the extrapolated net can be rewritten as a set of stationary refinement rules which define the new points in the vicinity of \mathbf{p} as linear combinations of points from the non-extrapolated net. However the refinement matrix is no longer block-circulant.

At every surface point lying on the boundary of a tangent plane continuous surface, one tangent direction is determined by the tangent of the boundary curve (which in this case is a four-point curve that does not depend on inner vertices). On boundaries, we can therefore drop the requirement of [18] that the leading eigenvalues of the refinement matrix have to be equal. This symmetry is only a consequence of the assumption that the rules to compute the new points around a singular vertex are identical modulo

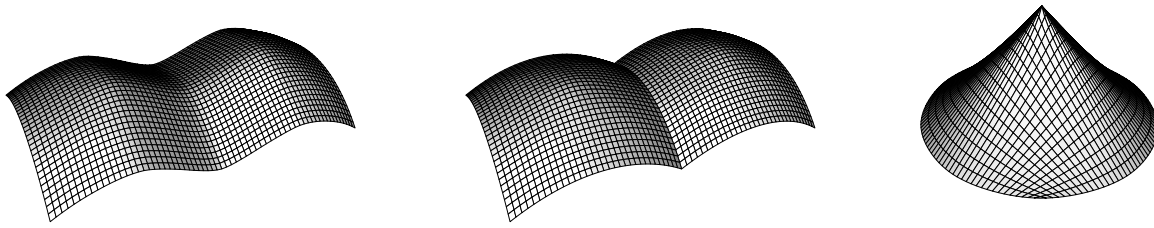

Figure 16: Modeling sharp features (piecewise smooth boundary, crease, cusp)

rotations (block-circulant refinement matrix). Although $\lambda_2 \neq \lambda_3$ causes an increasing local distortion of the net, the smoothness of the limiting surface is not affected. This effect can be viewed as a reparametrization in one direction. (Compare this to the distortion of a regular net which is refined by binary subdivision in one direction and trinary in the other.)

We summarize the different special cases which occur when refining an open net by the given rules. In Fig. 17 the net to be refined consists of the solid white faces while the extrapolated faces are drawn transparently. The dark vertex is marked as a corner vertex. We have to distinguish five different cases:

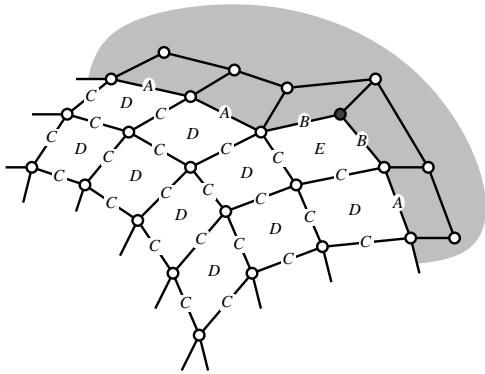

Figure 17: Occurrences of the different special cases.

- A:** Within boundary segments, we apply (11) to four succeeding boundary vertices.
- B:** To the first and the last edge of an open boundary segment, we apply the special rule (17).
- C:** Inner edge-points can be computed by application of (15). If necessary, extrapolated points are involved.
- D:** For every face-point of this class, at least one sequence of four C-points can be found to which (11) can be applied. If there are two possibilities for the choice of these points then both lead to the same result which is guaranteed by the construction of (15).
- E:** In this case no appropriate sequence of four C-points can be found. Therefore, one has to apply (17) to a B-point and the two C-points following on the opposite side of the corner face. In order to achieve independence of the grid direction, even in case the corner vertex is not marked, we apply (17) in both directions and compute the average of the two results.

3.6 Adaptive Refinement

In most numerical applications, the exponentially increasing number of vertices and faces during the iterative refinement only allows a small number of refinement steps to be computed. If high accuracy is needed, e.g., in finite element analysis or high quality rendering, it is usually sufficient to perform a high resolution refinement in re-

gions with high curvature while ‘flat’ regions may be approximated rather coarsely. Hence, in order to keep the amount of data reasonable, the next step is to introduce adaptive refinement features.

The decision *where* high resolution refinement is needed, strongly depends on the underlying application and is not discussed here. The major problem one always has to deal with when adaptive refinement of nets is performed is to handle or eliminate C^{-1} -inconsistencies which occur when faces from different refinement levels meet. A simple trick to repair the resulting triangular holes is to split the bigger face into three quadrilaterals in an Y-fashion (cf. Fig 18). However this Y-split does not repair the hole. Instead it shifts the hole to an adjacent edge. Only combining several Y-elements such that they build a ‘chain’ connecting two inconsistencies leads to an overall consistent net. The new vertices necessary for the Y-splits are computed by the rules of Sect. 3.3. The fact that every Y-element contains a singular ($n = 3$) vertex causes no problems for further refinement because this Y-element is only of temporary nature, i.e., if any of its three faces or any neighboring face is to be split by a following local refinement adaption, then first the Y-split is undone and a proper Catmull-Clark-type split is performed before proceeding. While this simple technique seems to be known in the engineering community, the author is not aware of any reference where the theoretical background for this technique is derived. Thus, we sketch a simple proof that shows under which conditions this technique applies.

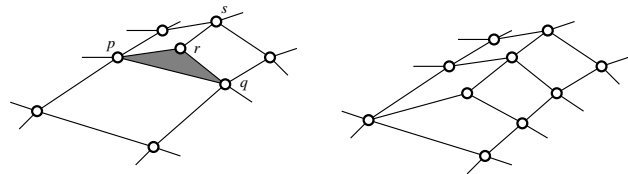

Figure 18: A hole in an adaptively refined net and an Y-element to fill it.

First, in order to apply the Y-technique we have to restrict the considered nets to *balanced* nets. These are adaptively refined nets (without Y-elements) where the refinement levels of neighboring faces differ at most by one. Non-balanced inconsistencies can not be handled by the Y-technique. Hence, looking at a particular face s from the n -th refinement level, all faces having at least one vertex in common with s are from the levels $(n - 1)$, n , or $(n + 1)$. For the proof we can think of first repairing all inconsistencies between level $n - 1$ and n and then proceed with higher levels. Thus, without loss of generality, we can restrict our considerations to a situation where all relevant faces are from level $(n - 1)$ or n .

A *critical edge* is an edge, where a triangular hole occurs due to different refinement levels of adjacent faces. A sequence of Y-elements can always be arranged such that two critical edges are connected, e.g., by surrounding one endpoint of the critical edge with a ‘corona’ of Y-elements until another critical edge is reached (cf. Fig. 19). Hence, on closed nets, we have to require the number of critical edges to be even. (On open nets, any boundary edge can

stop a chain of Y-elements.) We show that this is always satisfied, by induction over the number of faces from the n -th level within an environment of $(n - 1)$ -faces. Faces from generations $> n$ or $< (n - 1)$ do not affect the situation since we assume the net to be balanced.

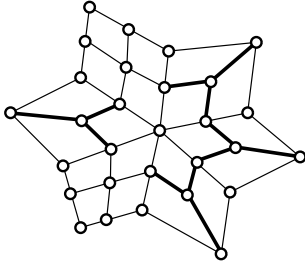

Figure 19: Combination of Y-elements

The first adaptive Catmull-Clark-type split on a uniformly refined net produces four critical edges. Every succeeding split changes the number of critical edges by an even number between -4 and 4 , depending on the number of direct neighbors that have been split before. Thus the number of critical edges is always even. However, the n -faces might form a ring having in total an even number of critical edges which are separated into an odd number ‘inside’ and an odd number ‘outside’. It turns out that this cannot happen: Let the inner region surrounded by the ring of n -faces consist of r quadrilaterals having a total number of $4r$ edges which are candidates for being critical. Every edge which is shared by two such quadrilaterals reduces the number of candidates by two and thus the number of boundary edges of this inner region is again even.

The only situation where the above argument is not valid, occurs when the considered net is open and has a hole with an odd number of boundary edges. In this case, every loop of n -faces enclosing this hole will have an odd number of critical edges on each side. Hence, we have to further restrict the class of nets to which we can apply the Y-technique to *open balanced nets which have no hole with an odd number of edges*. This restriction is not serious because one can transform any given net in order to satisfy this requirement by applying an *initial uniform refinement step* before adaptive refinement is started. Such an initial step is needed anyway if a given arbitrary net has to be transformed into a quadrilateral one (cf. Sect. 3.2).

It remains to find an *algorithm* to place the Y-elements correctly, i.e., to decide which critical edges should be connected by a corona. This problem is not trivial because interference between the Y-elements building the ‘shores’ of two ‘islands’ of n -faces lying close to each other, can occur. We describe an algorithm which only uses local information and decides the orientation separately for each face instead of ‘marching’ around the islands.

The initially given net (level 0) has been uniformly refined once before the adaptive refinement begins (level 1). Let every vertex of the adaptively refined net be associated with the generation in which it was introduced. Since all faces of the net are the result of a Catmull-Clark-type split (no Y-elements have been placed so far), they all have the property that three of its vertices belong to the same generation g and the fourth vertex belongs to a generation $g' < g$. This fact yields a unique orientation for every face. The algorithm starts by marking all vertices of the net which are endpoints of a critical edge, i.e. if a $(n - 1)$ -face $\{\mathbf{p}, \mathbf{q}, \dots\}$ meets two n -faces $\{\mathbf{p}, \mathbf{r}, \mathbf{s}, \dots\}$ and $\{\mathbf{q}, \mathbf{r}, \mathbf{s}, \dots\}$ then \mathbf{p} and \mathbf{q} are marked (cf. Fig. 18). After the *marking-phase*, the Y-elements are placed. Let $s = \{\mathbf{p}, \mathbf{q}, \mathbf{u}, \mathbf{v}\}$ be a face of the net where \mathbf{p} is the unique vertex which belongs to an elder generation than the other three. If neither \mathbf{q} nor \mathbf{v} are marked then no Y-element has to be placed within this face. If only one of them is marked then the Y-element has to be

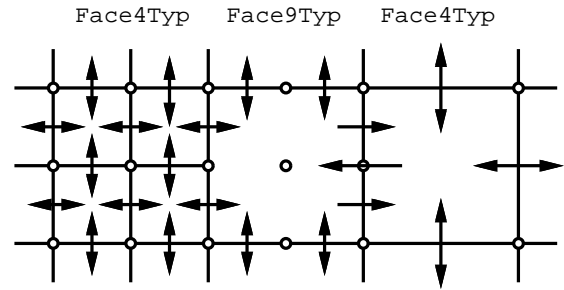

Figure 21: References between different kinds of faces.

oriented as shown in Fig. 20 and if both are marked this face has to be refined by a proper Catmull-Clark-type split.

The correctness of this algorithm is obvious since the vertices which are marked in the first phase are those which are common to faces of different levels. The second phase guarantees that a corona of Y-elements is built around each such vertex (cf. Fig. 19).

3.7 Implementation and Examples

The described algorithm is designed to be useful in practical applications. Therefore, besides the features for creating creases and cusps and the ability to adaptively refine a given quadrilateral net, efficiency and compact implementation are also important. Both can be achieved by this algorithm. The crucial point of the implementation is the design of an appropriate data structure which supports an efficient navigation through the neighborhood of the vertices. The most frequently needed access operation to the data structure representing the balanced net, is to enumerate all faces which lie around one vertex or to enumerate all the neighbors of one vertex. Thus every vertex should be associated with a linked list of the objects that constitute its vicinity. We propose to do this implicitly by storing the topological information in a data structure `Face4Typ` which contains all the information of one quadrilateral face, i.e., references to its four corner points and references to its four directly neighboring faces. By these references, a doubly linked list around every vertex is available.

Since we have to maintain an adaptively refined net, we need an additional datatype to consistently store connections between faces from different refinement levels. We define another structure `Face9Typ` which holds references to nine vertices and eight neighbors. These *multi-faces* can be considered as ‘almost’ split faces, where the geometric information (the new edge- and face-points) is already computed but the topological split has not yet been performed. If, during adaptive refinement, some n -face is split then all its neighbors which are from the same generation are converted into `Face9Typ`’s. Since these faces have pointers to eight neighbors, they can mimic faces from different generations and therefore connect them correctly. The `Face9Typ`’s are the candidates for the placement of Y-elements in order to re-establish consistency. The various references between the different kinds of faces are shown in Fig. 21.

To relieve the application program which decides where to adaptively refine, from keeping track of the balance of the net, the implementation of the refinement algorithm should perform recursive refinement operations when necessary, i.e., if a n -face s is to be refined then first all $(n - 1)$ -neighbors which have at least one vertex in common with s must be split.

The following pictures are generated by using our experimental implementation. The criterion for adaptive refinement is a discrete approximation of the Gaussian curvature. The running time of the algorithm is directly proportional to the number of computed points, i.e., to the complexity of the output-net. Hence, since the number of regions where deep refinement is necessary usually is

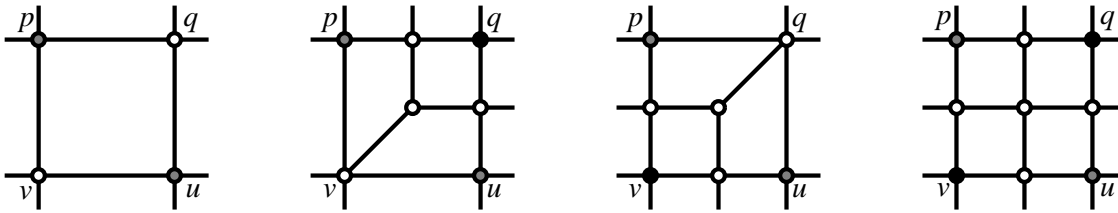

Figure 20: The orientation of the Y-elements depends on whether the vertices q and v are marked (black) or not (white). The status of vertices p and u does not matter (gray).

fixed, we can reduce the space- and time-complexity from exponential to linear (as a function of the highest occurring refinement level in the output).

References

- [1] A. Ball / D. Storry, *Conditions for Tangent Plane Continuity over Recursively Generated B-Spline Surfaces*, ACM Trans. Graph. 7 (1988), pp. 83–102
- [2] E. Catmull, J. Clark, *Recursively generated B-spline surfaces on arbitrary topological meshes*, CAD 10 (1978), pp. 350–355
- [3] A. Cavaretta / W. Dahmen / C. Micchelli, *Stationary Subdivision*, Memoirs of the AMS 93 (1991), pp. 1–186
- [4] D. Doo / M. Sabin, *Behaviour of Recursive Division Surfaces Near Extraordinary Points*, CAD 10 (1978), pp. 356–360
- [5] S. Dubuc, *Interpolation Through an Iterative Scheme*, Jour. of Mathem. Anal. and Appl., 114 (1986), pp. 185–204
- [6] N. Dyn / J. Gregory / D. Levin, *A 4-Point Interpolatory Subdivision Scheme for Curve Design*, CAGD 4(1987), pp. 257–268
- [7] N. Dyn / J. Gregory / D. Levin, *A Butterfly Subdivision Scheme for Surface Interpolation with Tension Control*, ACM Trans. Graph. 9 (1990), pp. 160–169
- [8] N. Dyn / D. Levin, *Interpolating subdivision schemes for the generation of curves and surfaces*, Multivar. Approx. and Interp., W. Häußmann and K. Jetter (eds.), 1990 Birkhäuser Verlag, Basel
- [9] N. Dyn, *Subdivision Schemes in Computer Aided Geometric Design*, Adv. in Num. Anal. II, Wavelets, Subdivisions and Radial Functions, W.A. Light ed., Oxford Univ. Press, 1991, pp. 36–104.
- [10] N. Dyn / D. Levin / D. Liu, *Interpolatory Convexity-Preserving Subdivision Schemes for Curves and Surfaces*, CAD 24 (1992), pp. 221–216
- [11] M. Halstead / M. Kass / T. DeRose, *Efficient, fair interpolation using Catmull-Clark surfaces*, Computer Graphics 27 (1993), pp. 35–44
- [12] H. Hoppe, *Surface Reconstruction from unorganized points*, Thesis, University of Washington, 1994
- [13] L. Kobbelt, *Using the Discrete Fourier-Transform to Analyze the Convergence of Subdivision Schemes*, Appl. Comp. Harmonic Anal. 5 (1998), pp. 68–91
- [14] C. Loop, *Smooth Subdivision Surfaces Based on Triangles*, Thesis, University of Utah, 1987
- [15] C. Loop, *A G^1 triangular spline surface of arbitrary topological type*, CAGD 11 (1994), pp. 303–330
- [16] J. Peters, *Smooth mesh interpolation with cubic patches*, CAD 22 (1990), pp. 109–120
- [17] J. Peters, *Smoothing polyhedra made easy*, ACM Trans. on Graph., Vol 14 (1995), pp. 161–169
- [18] U. Reif, *A unified approach to subdivision algorithms near extraordinary vertices*, CAGD 12 (1995), pp. 153–174
- [19] K. Schweizerhof, Universität Karlsruhe *private communication*

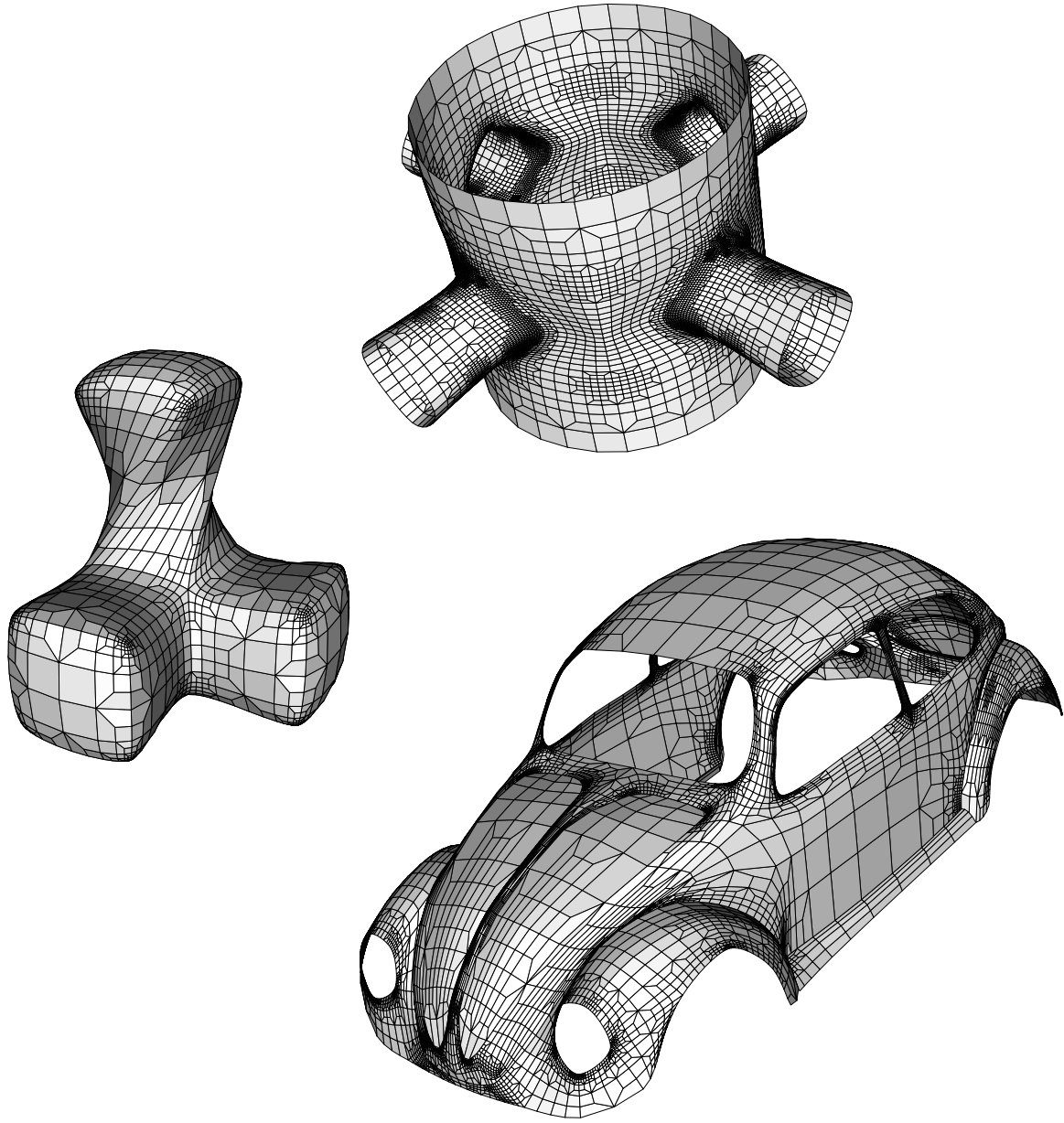

Figure 22: Examples for adaptively refined nets.

Chapter 8

A Variational Approach to Subdivision

Speaker: Leif Kobbelt

Variational Subdivision Schemes

Leif Kobbelt*

Max-Planck-Institute for Computer Sciences

Preface

The generic strategy of subdivision algorithms which is to define smooth curves and surfaces *algorithmically* by giving a set of simple rules for refining control polygons or meshes is a powerful technique to overcome many of the mathematical difficulties emerging from (polynomial) spline-based surface representations. In this section we highlight another application of the subdivision paradigm in the context of high quality surface generation.

From CAGD it is known that the technical and esthetic quality of a curve or a surface does not only depend on infinitesimal properties like the C^k differentiability. Much more important seems to be the *fairness* of a geometric object which is usually measured by curvature based energy functionals. A surface is hence considered optimal if it minimizes a given energy functional subject to auxiliary interpolation or approximation constraints.

Subdivision and fairing can be effectively combined into what is often referred to as *variational subdivision* or *discrete fairing*. The resulting algorithms inherit the simplicity and flexibility of subdivision schemes and the resulting curves and surfaces satisfy the sophisticated requirements for high end design in geometric modeling applications.

The basic idea that leads to variational subdivision schemes is that one subdivision step can be considered as a *topological split operation* where new vertices are introduced to increase the number of degrees of freedom, followed by a *smoothing operation* where the vertices are shifted in order to increase the overall smoothness. From this point of view it is natural to ask for the maximum smoothness that can be achieved on a given level of refinement while observing prescribed interpolation constraints.

We use an energy functional as a mathematical criterion to rate the smoothness of a polygon or a mesh. In the continuous setting, such scalar valued fairing functionals are typically defined as an integral over a combination of (squared) derivatives. In the discrete setting, we approximate such functionals by a sum over (squared) divided differences.

In the following we reproduce a few papers where this approach is described in more detail. In the univariate setting we consider interpolatory variational subdivision schemes which perform a greedy optimization in the sense that when computing the polygon \mathbf{P}_{m+1} from \mathbf{P}_m the new vertices' positions are determined by

an energy minimization process but when proceeding with \mathbf{P}_{m+2} the vertices of \mathbf{P}_{m+1} are not adjusted.

In the bivariate setting, i.e., the subdivision and optimization of triangle meshes, we start with a given control mesh \mathbf{P}_0 whose vertices are to be interpolated by the resulting mesh. In this case it turns out that the mesh quality can be improved significantly if we use all the vertices from $\mathbf{P}_m \setminus \mathbf{P}_0$ for the optimization in the m th subdivision step.

Hence the algorithmic structure of variational subdivision degenerates to an alternating refinement and (constrained) global optimization. In fact, from a different viewing angle the resulting algorithms perform like a multi-grid solver for the discretized optimization problem. This observation provides the mathematical justification for the *discrete fairing approach*.

For the efficient fairing of continuous parametric surfaces, the major difficulties arise from the fact that geometrically meaningful energy functionals depend on the control vertices in a highly non-linear fashion. As a consequence we have to either do non-linear optimization or we have to approximate the true functional by a linearized version. The reliability of this approximation usually depends on how close to isometric the surface's parameterization is. Alas, spline-patch-based surface representations often do not provide enough flexibility for an appropriate re-parameterization which would enable a feasible linearization of the geometric energy functional. Figure 1 shows two surfaces which are both optimal with respect to the same energy functional but for different parameterizations.

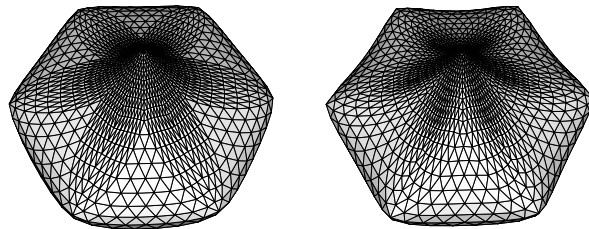

Figure 1: Optimal surfaces with respect to the same functional and interpolation constraints but for different parameterizations (isometric left, uniform right).

With the discrete fairing approach, we can exploit the auxiliary freedom to define an individual local parameterization for every vertex in the mesh. By this we find an isometric parameterization for each vertex and since the vertices are in fact the only points where the surface is evaluated, the linearized energy functional is a good approximation to the original one.

The discrete fairing machinery turns out to be a powerful tool which can facilitate the solution of many problems in the area of surface generation and modeling. The overall objective behind the presented applications will be the attempt to avoid, bypass, or at least delay the mathematically involved generation of spline CAD-models whenever it is appropriate.

*Computer Graphics Group, Max-Planck-Institute for Computer Sciences, Im Stadtwald, 66123 Saarbrücken, Germany, kobbelt@mpi-sb.mpg.de

I Univariate Variational Subdivision

In this paper a new class of interpolatory refinement schemes is presented which in every refinement step determine the new points by solving an optimization problem. In general, these schemes are global, i.e., every new point depends on all points of the polygon to be refined. By choosing appropriate quadratic functionals to be minimized iteratively during refinement, very efficient schemes producing limiting curves of high smoothness can be defined. The well known class of stationary interpolatory refinement schemes turns out to be a special case of these variational schemes.

The original paper which also contains the omitted proofs has been published in:

L. Kobbelt
A Variational Approach to Subdivision,
CAGD 13 (1996) pp. 743–761, Elsevier

1.1 Introduction

Interpolatory refinement is a very intuitive concept for the construction of interpolating curves or surfaces. Given a set of points $\mathbf{p}_i^0 \in \mathbf{R}^d$ which are to be interpolated by a smooth curve, the first step of a refinement scheme consists in connecting the points by a piecewise linear curve and thus defining a polygon $\mathbf{P}_0 = (\mathbf{p}_0^0, \dots, \mathbf{p}_{n-1}^0)$.

This initial polygon can be considered as a very coarse approximation to the final interpolating curve. The approximation can be improved by inserting new points between the old ones, i.e., by subdividing the edges of the given polygon. The positions of the new points \mathbf{p}_{2i+1}^1 have to be chosen appropriately such that the resulting (refined) polygon $\mathbf{P}_1 = (\mathbf{p}_0^1, \dots, \mathbf{p}_{2n-1}^1)$ looks *smoother* than the given one in some sense (cf. Fig. 2). Interpolation of the given points is guaranteed since the old points $\mathbf{p}_i^0 = \mathbf{p}_{2i}^1$ still belong to the finer approximation.

By iteratively applying this interpolatory refinement operation, a sequence of polygons (\mathbf{P}_m) is generated with vertices becoming more and more dense and which satisfy the interpolation condition $\mathbf{p}_i^m = \mathbf{p}_{2i}^{m+1}$ for all i and m . This sequence may converge to a smooth limit \mathbf{P}_∞ .

Many authors have proposed different schemes by explicitly giving particular rules how to compute the new points \mathbf{p}_{2i+1}^{m+1} as a function of the polygon \mathbf{P}_m to be refined. In (Dubuc, 1986) a simple refinement scheme is proposed which uses four neighboring vertices to compute the position of a new point. The position is determined in terms of the unique cubic polynomial which uniformly interpolates these four points. The limiting curves generated by this scheme are smooth, i.e., they are differentiable with respect to an equidistant parametrisation.

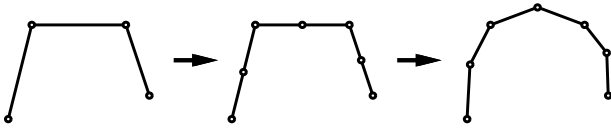

Figure 2: Interpolatory refinement

In (Dyn et al., 1987) this scheme is generalized by introducing an additional design or tension parameter. Replacing the interpolating cubic by interpolating polynomials of arbitrary degree leads to the *Lagrange-schemes* proposed in (Deslauriers & Dubuc, 1989). Raising the degree to $(2k+1)$, every new point depends on $(2k+2)$ old points of its vicinity. In (Kobbelt, 1995a) it is shown that at least for moderate k these schemes produce C^k -curves.

Appropriate formalisms have been developed in (Cavaretta et al., 1991), (Dyn & Levin, 1990), (Dyn, 1991) and elsewhere that allow an easy analysis of such *stationary schemes* which compute the new points by applying fixed banded convolution operators to the original polygon. In (Kobbelt, 1995b) simple criteria are given which can be applied to convolution schemes without any band limitation as well (cf. Theorem 2).

(Dyn et al., 1992) and (Le Méhauté & Utreras, 1994) propose non-linear refinement schemes which produce smooth interpolating (C^1 -) curves and additionally preserve the convexity properties of the initial data. Both of them introduce constraints which locally define areas where the new points are restricted to lie in. Another possibility to define interpolatory refinement schemes is to dualize corner-cutting algorithms (Paluszny et al., 1994). This approach leads to more general necessary and sufficient convergence criteria.

In this paper we want to define interpolatory refinement schemes in a more systematic fashion. The major principle is the following: We are looking for refinement schemes for which, given a polygon \mathbf{P}_m , the refined polygon \mathbf{P}_{m+1} is *as smooth as possible*. In order to be able to compare the “smoothness” of two polygons we define functionals $E(\mathbf{P}_{m+1})$ which measure the total amount of (discrete) strain energy of \mathbf{P}_{m+1} . The refinement operator then simply chooses the new points \mathbf{p}_{2i+1}^{m+1} such that this functional becomes a minimum.

An important motivation for this approach is that in practice good approximations to the final interpolating curves should be achieved with little computational effort, i.e., maximum smoothness after a minimal number of refinement steps is wanted. In non-discrete curve design based, e.g., on splines, the concept of defining interpolating curves by the minimization of some energy functional (*fairing*) is very familiar (Meier & Nowacki, 1987), (Sapidis, 1994).

This basic idea of making a variational approach to the definition of refinement schemes can also be used for the definition of schemes which produce smooth surfaces by refining a given triangular or quadrilateral net. However, due to the global dependence of the new points from the given net, the convergence analysis of such schemes strongly depends on the topology of the net to be refined and is still an open question. Numerical experiments with such schemes show that this approach is very promising. In this paper we will only address the analysis of univariate schemes.

1.2 Known results

Given an arbitrary (open/closed) polygon $\mathbf{P}_m = (\mathbf{p}_i^m)$, the *difference polygon* $\Delta^k \mathbf{P}_m$ denotes the polygon whose vertices are the vectors

$$\Delta^k \mathbf{p}_i^m := \sum_{j=0}^k \binom{k}{j} (-1)^{k+j} \mathbf{p}_{i+j}^m.$$

In (Kobbelt, 1995b) the following characterization of sequences of polygons (\mathbf{P}_m) generated by the iterative application of an interpolatory refinement scheme is given:

Lemma 1 *Let (\mathbf{P}_m) be a sequence of polygons. The scheme by which they are generated is an interpolatory refinement scheme (i.e., $\mathbf{p}_i^m = \mathbf{p}_{2i}^{m+1}$ for all i and m) if and only if for all $m, k \in \mathbf{N}$ the condition*

$$\Delta^k \mathbf{p}_i^m = \sum_{j=0}^k \binom{k}{j} \Delta^k \mathbf{p}_{2i+j}^{m+1}$$

holds for all indices i of the polygon $\Delta^k \mathbf{P}_m$.

Also in (Kobbelt, 1995b), the following sufficient convergence criterion is proven which we will use in the convergence analysis in the next sections.

Theorem 2 Let (\mathbf{P}_m) be a sequence of polygons generated by the iterative application of an arbitrary interpolatory refinement scheme. If

$$\sum_{m=0}^{\infty} \|2^{km} \Delta^{k+l} \mathbf{P}_m\|_{\infty} < \infty$$

for some $l \in \mathbf{N}$ then the sequence (\mathbf{P}_m) uniformly converges to a k -times continuously differentiable curve \mathbf{P}_{∞} .

This theorem holds for all kinds of interpolatory schemes on open and closed polygons. However, in this paper we will only apply it to linear schemes whose support is global.

1.3 A variational approach to interpolatory refinement

In this and the next two sections we focus on the refinement of closed polygons, since this simplifies the description of the refinement schemes. Open polygons will be considered in Section 1.6.

Let $\mathbf{P}_m = (\mathbf{p}_0^m, \dots, \mathbf{p}_{n-1}^m)$ be a given polygon. We want $\mathbf{P}_{m+1} = (\mathbf{p}_0^{m+1}, \dots, \mathbf{p}_{2n-1}^{m+1})$ to be the smoothest polygon for which the interpolation condition $\mathbf{p}_{2i}^{m+1} = \mathbf{p}_i^m$ holds. Since the roughness at some vertex \mathbf{p}_i^{m+1} is a local property we measure it by an operator

$$K(\mathbf{p}_i^{m+1}) := \sum_{j=0}^k \alpha_j \mathbf{p}_{i+j-r}^{m+1}.$$

The coefficients α_j in this definition can be an arbitrary finite sequence of real numbers. The indices of the vertices \mathbf{p}_i^{m+1} are taken modulo $2n$ according to the topological structure of the closed polygon \mathbf{P}_{m+1} . To achieve full generality we introduce the shift r such that $K(\mathbf{p}_i^{m+1})$ depends on $\mathbf{p}_{i-r}^{m+1}, \dots, \mathbf{p}_{i+k-r}^{m+1}$. Every discrete measure of roughness K is associated with a characteristic polynomial

$$\alpha(z) = \sum_{j=0}^k \alpha_j z^j.$$

Our goal is to minimize the total strain energy over the whole polygon \mathbf{P}_{m+1} . Hence we define

$$E(\mathbf{P}_{m+1}) := \sum_{i=0}^{2n-1} K(\mathbf{p}_i^{m+1})^2 \quad (1)$$

to be the energy functional which should become minimal. Since the points \mathbf{p}_{2i}^{m+1} of \mathbf{P}_{m+1} with even indices are fixed due to the interpolation condition, the points \mathbf{p}_{2i+1}^{m+1} with odd indices are the only free parameters of this optimization problem. The unique minimum of the quadratic functional is attained at the common root of all partial derivatives:

$$\begin{aligned} \frac{\partial}{\partial \mathbf{p}_{2l+1}^{m+1}} E(\mathbf{P}_{m+1}) &= \sum_{i=0}^k \frac{\partial}{\partial \mathbf{p}_{2l+1}^{m+1}} K(\mathbf{p}_{2l+1+r-i}^{m+1})^2 \\ &= 2 \sum_{i=0}^k \alpha_i \sum_{j=0}^k \alpha_j \mathbf{p}_{2l+1-i+j}^{m+1} \\ &= 2 \sum_{i=-k}^k \beta_i \mathbf{p}_{2l+1+i}^{m+1} \end{aligned} \quad (2)$$

with the coefficients

$$\beta_{-i} = \beta_i = \sum_{j=0}^{k-i} \alpha_j \alpha_{j+i}, \quad i = 0, \dots, k. \quad (3)$$

Hence, the strain energy $E(\mathbf{P}_{m+1})$ becomes minimal if the new points \mathbf{p}_{2i+1}^{m+1} are the solution of the linear system

$$\begin{pmatrix} \beta_0 & \beta_2 & \beta_4 & \dots & \beta_2 & \beta_0 \\ \beta_2 & \beta_0 & \beta_2 & \dots & \beta_4 & \beta_2 \\ \vdots & \vdots & \vdots & \ddots & \vdots & \vdots \end{pmatrix} \begin{pmatrix} \mathbf{p}_1^{m+1} \\ \mathbf{p}_3^{m+1} \\ \vdots \\ \mathbf{p}_{2n-1}^{m+1} \end{pmatrix} = \begin{pmatrix} \mathbf{p}_0^m \\ \mathbf{p}_1^m \\ \vdots \\ \mathbf{p}_{n-1}^m \end{pmatrix} \quad (4)$$

which follows from (2) by separation of the fixed points $\mathbf{p}_{2i}^{m+1} = \mathbf{p}_i^m$ from the variables. Here, both matrices are circulant and (almost) symmetric. A consequence of this symmetry is that the new points do not depend on the orientation by which the vertices are numbered (left to right or vice versa).

To emphasize the analogy between curve fairing and interpolatory refinement by variational methods, we call the equation

$$\sum_{i=-k}^k \beta_i \mathbf{p}_{2l+1+i}^{m+1} = 0, \quad l = 0, \dots, n-1 \quad (5)$$

the Euler-Lagrange-equation.

Theorem 3 The minimization of $E(\mathbf{P}_{m+1})$ has a well-defined solution if and only if the characteristic polynomial $\alpha(z)$ for the local measure K has no diametric roots $z = \pm \omega$ on the unit circle with $\text{Arg}(\omega) \in \pi \mathbf{N}/n$. (Proof to be found in the original paper)

Remark The set $\pi \mathbf{N}/2^m$ becomes dense in \mathbf{R} for increasing refinement depth $m \rightarrow \infty$. Since we are interested in the smoothness properties of the limiting curve \mathbf{P}_{∞} , we should drop the restriction that the diametric roots have to have $\text{Arg}(\omega) \in \pi \mathbf{N}/n$. For stability reasons we require $\alpha(z)$ to have no diametric roots on the unit circle at all.

The optimization by which the new points are determined is a geometric process. In order to obtain meaningful schemes, we have to introduce more restrictions on the energy functionals E or on the measures of roughness K .

For the expression $K^2(\mathbf{p}_i)$ to be valid, K has to be vector valued, i.e., the sum of the coefficients α_j has to be zero. This is equivalent to $\alpha(1) = 0$. Since

$$\sum_{i=-k}^k \beta_i = \sum_{i=0}^k \sum_{j=0}^k \alpha_i \alpha_j = \left(\sum_{j=0}^k \alpha_j \right)^2$$

the sum of the coefficients β_i also vanishes in this case and affine invariance of the (linear) scheme is guaranteed because constant functions are reproduced.

1.4 Implicit refinement schemes

In the last section we showed that the minimization of a quadratic energy functional (1) leads to the conditions (5) which determine the solution. Dropping the variational background, we can more generally prescribe arbitrary real coefficients $\beta_{-k}, \dots, \beta_k$ (with

$\beta_{-i} = \beta_i$ to establish symmetry and $\sum \beta_i = 0$ for affine invariance) and define an interpolatory refinement scheme which chooses the new points \mathbf{p}_{2i+1}^{m+1} of the refined polygon \mathbf{P}_{m+1} such that the homogeneous constraints

$$\sum_{i=-k}^k \beta_i \mathbf{p}_{2l+1+i}^{m+1} = 0, \quad l = 0, \dots, n-1 \quad (6)$$

are satisfied. We call these schemes: *implicit refinement schemes* to emphasize the important difference to other refinement schemes where usually the new points are computed by one or two *explicitly* given rules (cf. the term *implicit curves* for curves represented by $f(x, y) = 0$). The stationary refinement schemes are a special case of the implicit schemes where $\beta_{2j} = \delta_{j,0}$. In general, the implicit schemes are non-stationary since the resulting weight coefficients by which the new points \mathbf{p}_{2i+1}^{m+1} are computed depend on the number of vertices in \mathbf{P}_m .

In (Kobbelt, 1995b) a general technique is presented which allows to analyse the smoothness properties of the limiting curve generated by a given implicit refinement scheme.

The next theorem reveals that the class of implicit refinement schemes is not essentially larger than the class of variational schemes.

Theorem 4 *Let $\beta_{-k}, \dots, \beta_k$ be an arbitrary symmetric set of real coefficients ($\beta_{-i} = \beta_i$). Then there always exists a (potentially complex valued) local roughness measure K such that (6) is the Euler-Lagrange-equation corresponding to the minimization of the energy functional (1). (Proof to be found in the original paper)*

Remark We do not consider implicit refinement schemes with complex coefficients β_i since then (6) in general has no real solutions.

Example To illustrate the statement of the last theorem we look at the 4-point scheme of (Dubuc, 1986). This is a stationary refinement scheme where the new points \mathbf{p}_{2i+1}^{m+1} are computed by the rule

$$\mathbf{p}_{2i+1}^{m+1} = \frac{9}{16} (\mathbf{p}_i^m + \mathbf{p}_{i+1}^m) - \frac{1}{16} (\mathbf{p}_{i-1}^m + \mathbf{p}_{i+2}^m).$$

The scheme can be written in implicit form (6) with $k = 3$ and $\beta_{\pm 3} = 1$, $\beta_{\pm 2} = 0$, $\beta_{\pm 1} = -9$, $\beta_0 = 16$ since the common factor $\frac{1}{16}$ is not relevant. The roots of $\beta(z)$ are $z_1 = \dots = z_4 = 1$ and $z_{5,6} = -2 \pm \sqrt{3}$. From the construction of the last proof we obtain

$$\alpha(z) = (2 + \sqrt{3}) - (3 + \sqrt{12})z + \sqrt{3}z^2 + z^3$$

as one possible solution. Hence, the quadratic strain energy which is minimized by the 4-point scheme is based on the local roughness estimate

$$K(\mathbf{p}_i) = (2 + \sqrt{3}) \mathbf{p}_i - (3 + \sqrt{12}) \mathbf{p}_{i+1} + \sqrt{3} \mathbf{p}_{i+2} + \mathbf{p}_{i+3}.$$

1.5 Minimization of differences

Theorem 2 asserts that a fast contraction rate of some higher differences is sufficient for the convergence of a sequence of polygons to a (k times) continuously differentiable limit curve. Thus it is natural to look for refinement schemes with a maximum contraction of differences. This obviously is an application of the variational approach. For the quadratic energy functional we make the ansatz

$$E_k(\mathbf{P}_{m+1}) := \sum_{i=0}^{2n-1} \|\Delta^k \mathbf{p}_i^{m+1}\|^2. \quad (7)$$

The partial derivatives take a very simple form in this case

$$\begin{aligned} \frac{\partial}{\partial \mathbf{p}_{2l+1}^{m+1}} E_k(\mathbf{P}_{m+1}) &= \sum_{i=0}^k \frac{\partial}{\partial \mathbf{p}_{2l+1}^{m+1}} \|\Delta^k \mathbf{p}_{2l+1-i}^{m+1}\|^2 \\ &= 2 \sum_{i=0}^k (-1)^{k+i} \binom{k}{i} \Delta^k \mathbf{p}_{2l+1-i}^{m+1} \\ &= 2(-1)^k \Delta^{2k} \mathbf{p}_{2l+1-k}^{m+1}. \end{aligned}$$

and the corresponding Euler-Lagrange-equation is

$$\Delta^{2k} \mathbf{p}_{2l+1-k}^{m+1} = 0, \quad l = 0, \dots, n-1 \quad (8)$$

where, again, the indices of the \mathbf{p}_i^{m+1} are taken *modulo* $2n$. The characteristic polynomial of the underlying roughness measure K is $\alpha(z) = (z-1)^k$ and thus solvability and affine invariance of the refinement scheme are guaranteed. The solution of (8) only requires the inversion of a banded circulant matrix with bandwidth $2 \lfloor \frac{k}{2} \rfloor + 1$.

Theorem 5 *The refinement scheme based on the minimization of E_k in (7) produces at least C^k -curves. (Proof to be found in the original paper)*

In order to prove even higher regularities of the limiting curve one has to combine more refinement steps. In (Kobbelt, 1995b) a simple technique is presented that allows to do the convergence analysis of such multi-step schemes numerically. Table 1 shows some results where r denotes the number of steps that have to be combined in order to obtain these differentiabilitys.

In analogy to the non-discrete case where the minimization of the integral over the squared k -th derivative has piecewise polynomial C^{2k-2} solutions (B-splines), it is very likely that the limiting curves generated by iterative minimization of E_k are actually in C^{2k-2} too. The results given in Table 1 can be improved by combining more than r steps. For $k = 2, 3$, however, sufficiently many steps have already been combined to verify $\mathbf{P}_\infty \in C^{2k-2}$.

k	r	diff ^{ty}	k	r	diff ^{ty}
2	2	C^2	7	6	C^{10}
3	11	C^4	8	4	C^{11}
4	2	C^5	9	6	C^{13}
5	7	C^7	10	4	C^{14}
6	3	C^8	11	6	C^{16}

Table 1: Lower bounds on the differentiability of \mathbf{P}_∞ generated by iterative minimization of $E_k(\mathbf{P}_m)$.

For illustration and to compare the quality of the curves generated by these schemes, some examples are given in Fig. 3. The curves result from applying different schemes to the initial data $\mathbf{P}_0 = (\dots, 0, 1, 0, \dots)$. We only show the middle part of one periodic interval of \mathbf{P}_∞ . As expected, the decay of the function becomes slower as the smoothness increases.

Remark Considering Theorem 2 it would be more appropriate to minimize the maximum difference $\|\Delta^k \mathbf{P}_m\|_\infty$ instead of $\|\Delta^k \mathbf{P}_m\|_2$. However, this leads to non-linear refinement schemes which are both, hard to compute and difficult to analyse. Moreover, in (Kobbelt, 1995a) it is shown that a contraction rate of

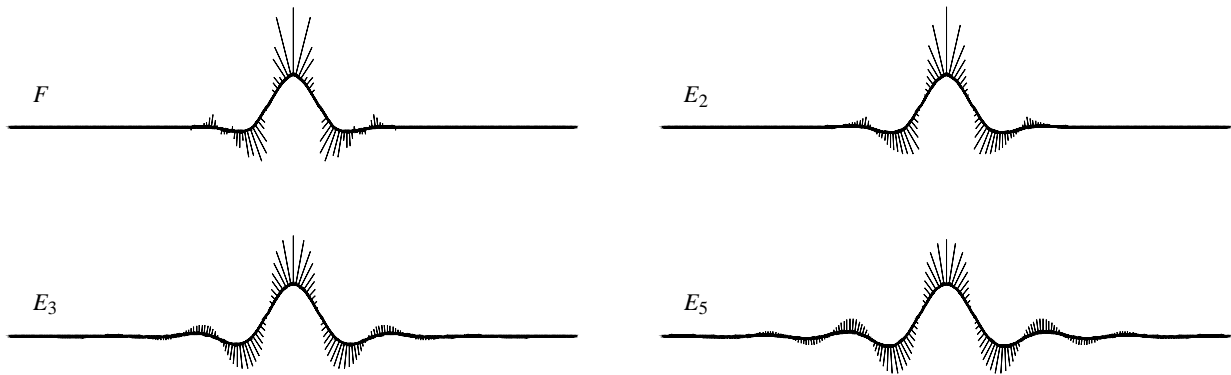

Figure 3: Discrete curvature plots of finite approximations to the curves generated by the four-point scheme F ($\mathbf{P}_\infty \in C^1$) and the iterative minimization of E_2 ($\mathbf{P}_\infty \in C^2$), E_3 ($\mathbf{P}_\infty \in C^4$) and E_5 ($\mathbf{P}_\infty \in C^7$).

$\|\Delta^{2k} \mathbf{P}_m\|_\infty = O(2^{-mk})$ implies $\|\Delta^k \mathbf{P}_m\|_\infty = O(2^{-m(k-\varepsilon)})$ for every $\varepsilon > 0$. It is further shown that $\|\Delta^k \mathbf{P}_m\|_\infty = O(2^{-mk})$ is the theoretical fastest contraction which can be achieved by interpolatory refinement schemes. Hence, the minimization of $\|\Delta^k \mathbf{P}_m\|_\infty$ cannot improve the asymptotic behavior of the contraction.

1.6 Interpolatory refinement of open polygons

The convergence analysis of variational schemes in the case of open finite polygons is much more difficult than it is in the case of closed polygons. The problems arise at both ends of the polygons \mathbf{P}_m where the regular topological structure is disturbed. Therefore, we can no longer describe the refinement operation in terms of Toeplitz matrices but we have to use matrices which are Toeplitz matrices almost everywhere except for a finite number of rows, i.e., except for the first and the last few rows.

However, one can show that in a middle region of the polygon to be refined the smoothing properties of an implicit refinement scheme applied to an open polygon do not differ very much from the same scheme applied to a closed polygon. This is due to the fact that in both cases the influence of the old points \mathbf{p}_i^m on a new point \mathbf{p}_{2j+1}^{m+1} decrease exponentially with increasing topological distance $|i-j|$ for all asymptotically stable schemes (Kobbelt, 1995a).

For the refinement schemes which iteratively minimize forward differences, we can at least prove the following.

Theorem 6 *The interpolatory refinement of open polygons by iteratively minimizing the $2k$ -th differences, generates at least C^{k-1} -curves. (Proof to be found in the original paper)*

The statement of this theorem only gives a lower bound for the differentiability of the limiting curve \mathbf{P}_∞ . However, the author conjectures that the differentiability agree in the open and closed polygon case. For special cases we can prove better results.

Theorem 7 *The interpolatory refinement of open polygons by iteratively minimizing the second differences, generates at least C^2 -curves. (Proof to be found in the original paper)*

1.7 Local refinement schemes

By now we only considered refinement schemes which are based on a *global* optimization problem. In order to construct local refinement schemes we can restrict the optimization to some local subpolygon. This means a new point \mathbf{p}_{2l+1}^{m+1} is computed by minimizing some energy functional over a *window* $\mathbf{p}_{l-r}^m, \dots, \mathbf{p}_{l+1+r}^m$. As the index l varies, the window is shifted in the same way.

Let E be a given quadratic energy functional. The solution of its minimization over the window $\mathbf{p}_{l-r}^m, \dots, \mathbf{p}_{l+1+r}^m$ is computed by solving an Euler-Lagrange-equation

$$B(\mathbf{p}_{2l+1+2i}^{m+1})_{i=-r}^r = C(\mathbf{p}_{l+i}^m)_{i=-r}^{r+1}. \quad (9)$$

The matrix of $B^{-1}C$ can be computed explicitly and the weight coefficients by which a new point \mathbf{p}_{2l+1}^{m+1} is computed, can be read off from the corresponding row in $B^{-1}C$. Since the coefficients depend on E and r only, this construction yields a stationary refinement scheme.

For such local schemes the convergence analysis is independent from the topological structure (open/closed) of the polygons to be refined. The formalisms of (Cavaretta et al., 1991), (Dyn & Levin, 1990) or (Kobbelt, 1995b) can be applied.

Minimizing the special energy functional $E_k(\mathbf{P})$ from (7) over open polygons allows the interesting observation that the resulting refinement scheme has polynomial precision of degree $k-1$. This is obvious since for points lying equidistantly parameterized on a polynomial curve of degree $k-1$, all k -th differences vanish and $E_k(\mathbf{P}) = 0$ clearly is the minimum of the quadratic functional.

Since the $2r+2$ points which form the subpolygon $\mathbf{p}_{l-r}^m, \dots, \mathbf{p}_{l+1+r}^m$ uniquely define an interpolating polynomial of degree $2r+1$, it follows that the local schemes based on the minimization of $E_k(\mathbf{P})$ are identical for $k \geq 2r+2$. These schemes coincide with the Lagrange-schemes of (Deslauriers & Dubuc, 1989). Notice that $k \leq 4r+2$ is necessary because higher differences are not possible on the polygon $\mathbf{p}_{2(l-r)}^{m+1}, \dots, \mathbf{p}_{2(l+1+r)}^{m+1}$ and minimizing $E_k(\mathbf{P}) \equiv 0$ makes no sense.

The local variational schemes provide a nice feature for practical purposes. One can use the refinement rules defined by the coefficients in the rows of $B^{-1}C$ in (9) to compute points which subdivide edges near the ends of open polygons. Pure stationary refinement schemes do not have this option and one therefore has to deal with *shrinking ends*. This means one only subdivides those edges which allow the application of the given subdivision mask and cuts off the remaining part of the unrefined polygon.

If $k \geq 2r+2$ then the use of these auxiliary rules causes the limiting curve to have a polynomial segment at both ends. This can be seen as follows. Let $\mathbf{P}_0 = (\mathbf{p}_0^0, \dots, \mathbf{p}_n^0)$ be a given polygon and denote the polynomial of degree $2r+1 \leq k-1$ uniformly interpolating the points $\mathbf{p}_0^0, \dots, \mathbf{p}_{2r+1}^0$ by $f(x)$.

The first vertex of the refined polygon \mathbf{P}_1 which not necessarily lies on $f(x)$ is \mathbf{p}_{2r+3}^1 . Applying the same refinement scheme iteratively, we see that if $\mathbf{p}_{\delta_m}^m$ is the first vertex of \mathbf{P}_m which does not lie

on $f(x)$ then $\mathbf{p}_{\delta_{m+1}}^{m+1} = \mathbf{p}_{2\delta_m - 2r - 1}^{m+1}$ is the first vertex of \mathbf{P}_{m+1} with this property. Let $\delta_0 = 2r + 2$ and consider the sequence

$$\lim_{m \rightarrow \infty} \frac{\delta_m}{2^m} = (2r + 2) - (2r + 1) \lim_{m \rightarrow \infty} \sum_{i=1}^m 2^{-i} = 1.$$

Hence, the limiting curve \mathbf{P}_∞ has a polynomial segment $f(x)$ between the points \mathbf{p}_0^0 and \mathbf{p}_1^0 . An analog statement holds at the opposite end between \mathbf{p}_{n-1}^0 and \mathbf{p}_n^0 .

This feature also arises naturally in the context of Lagrange-schemes where the new points near the ends of an open polygon can be chosen to lie on the first or last well-defined polynomial. It can be used to exactly compute the derivatives at the endpoints \mathbf{p}_0^0 and \mathbf{p}_n^0 of the limiting curve and it also provides the possibility to smoothly connect refinement curves and polynomial splines.

1.8 Computational Aspects

Since for the variational refinement schemes the computation of the new points \mathbf{p}_{2i+1}^{m+1} involves the solution of a linear system, the algorithmic structure of these schemes is slightly more complicated than it is in the case of stationary refinement schemes. However, for the refinement of an open polygon \mathbf{P}_m the computational complexity is still linear in the length of \mathbf{P}_m . The matrix of the system that has to be solved, is a banded Toeplitz-matrix with a small number of perturbations at the boundaries.

In the closed polygon case, the best we can do is to solve the circulant system in the Fourier domain. In particular, we transform the initial polygon \mathbf{P}_0 once and then perform m refinement steps in the Fourier domain where the convolution operator becomes a diagonal operator. The refined spectrum $\hat{\mathbf{P}}_m$ is finally transformed back in order to obtain the result \mathbf{P}_m . The details can be found in (Kobbelt, 1995c). For this algorithm, the computational costs are dominated by the discrete Fourier transformation of $\hat{\mathbf{P}}_m$ which can be done in $O(n \log(n)) = O(2^m m)$ steps. This is obvious since the number $n = 2^m n_0$ of points in the refined polygon \mathbf{P}_m allows to apply m steps of the fast Fourier transform algorithm.

The costs for computing \mathbf{P}_m are therefore $O(m)$ per point compared to $O(1)$ for stationary schemes. However, since in practice only a small number of refinement steps are computed, the constant factors which are hidden within these asymptotic estimates are relevant. Thus, the fact that implicit schemes need a smaller bandwidth than stationary schemes to obtain the same differentiability of the limiting curve (cf. Table 1) equalizes the performance of both.

In the implementation of these algorithms it turned out that all these computational costs are dominated by the ‘administrative’ overhead which is necessary, e.g., to build up the data structures. Hence, the differences in efficiency between stationary and implicit refinement schemes can be neglected.

References

[Cavaretta et al., 1991] Cavaretta, A. and Dahmen, W. and Micchelli, C. (1991), Stationary Subdivision, *Memoirs of the AMS* 93, 1–186

[Clegg, 1970] Clegg, J. (1970), *Variationsrechnung*, Teubner Verlag, Stuttgart

[Deslauriers & Dubuc, 1989] Deslauriers, G. and Dubuc, S. (1989), Symmetric iterative interpolation processes, *Constructive Approximation* 5, 49–68

[Dubuc, 1986] Dubuc, S. (1986), Interpolation through an iterative scheme, *Jour. of Mathem. Anal. and Appl.* 114, 185–204

[Dyn et al., 1987] Dyn, N. and Gregory, J. and Levin, D. (1987), A 4-point interpolatory subdivision scheme for curve design, *CAGD* 4, 257–268

[Dyn & Levin, 1990] Dyn, N. and Levin, D. (1990), Interpolating subdivision schemes for the generation of curves and surfaces, in: Haubmann W. and Jetter K. eds., *Multivariate Approximation and Interpolation*, Birkhäuser Verlag, Basel

[Dyn et al., 1992] Dyn, N. and Levin, D. and Liu, D. (1992), Interpolatory convexity-preserving subdivision schemes for curves and surfaces, *CAD* 24, 221–216

[Dyn, 1991] Dyn, N. (1991), Subdivision schemes in computer aided geometric design, in: Light, W. ed., *Advances in Numerical Analysis II, Wavelets, Subdivisions and Radial Functions*, Oxford University Press

[Golub & Van Loan, 1989] Golub, G. and Van Loan, C. (1989), *Matrix Computations*, John Hopkins University Press

[Kobbelt, 1995a] Kobbelt, L. (1995a), *Iterative Erzeugung glatter Interpolanten*, Universität Karlsruhe

[Kobbelt, 1995b] Kobbelt, L. (1995b), Using the Discrete Fourier Transform to Analyze the Convergence of Subdivision Schemes, *Appl. Comp. Harmonic Anal.* 5 (1998), pp. 68–91

[Kobbelt, 1995c] Kobbelt, L. (1995c), Interpolatory Refinement is Low Pass Filtering, in Daehlen, M. and Lyche, T. and Schumaker, L. eds., *Math. Meth in CAGD III*

[Meier & Nowacki, 1987] Meier, H. and Nowacki, H. (1987), Interpolating curves with gradual changes in curvature, *CAGD* 4, 297–305

[Le Méhauté & Utreras, 1994] Le Méhauté A. and Utreras, F. (1994), Convexity-preserving interpolatory subdivision, *CAGD* 11, 17–37

[Paluszny et al., 1994] Paluszny M. and Prautzsch H. and Schäfer, M. (1994), Corner cutting and interpolatory refinement, Preprint

[Sapidis, 1994] Sapidis, N. (1994), *Designing Fair Curves and Surfaces*, SIAM, Philadelphia

[Widom, 1965] Widom, H. (1965), Toeplitz matrices, in: Hirschmann, I. ed., *Studies in Real and Complex Analysis*, MAA Studies in Mathematics 3

II Discrete Fairing

Many mathematical problems in geometric modeling are merely due to the difficulties of handling piecewise polynomial parameterizations of surfaces (e.g., smooth connection of patches, evaluation of geometric fairness measures). Dealing with polygonal meshes is mathematically much easier although infinitesimal smoothness can no longer be achieved. However, transferring the notion of fairness to the discrete setting of triangle meshes allows to develop very efficient algorithms for many specific tasks within the design process of high quality surfaces. The use of discrete meshes instead of continuous spline surfaces is tolerable in all applications where (on an intermediate stage) explicit parameterizations are not necessary. We explain the basic technique of discrete fairing and give a survey of possible applications of this approach.

The original paper has been published in:

L. Kobbelt
*Variational Design with Parametric Meshes
of Arbitrary Topology,*
in Creating fair and shape preserving curves
and surfaces, Teubner, 1998

2.1 Introduction

Piecewise polynomial spline surfaces have been the standard representation for free form surfaces in all areas of CAD/CAM over the last decades (and still are). However, although B-splines are optimal with respect to certain desirable properties (differentiability, approximation order, locality, ...), there are several tasks that cannot be performed easily when surface parameterizations are based on piecewise polynomials. Such tasks include the construction of globally smooth closed surfaces and the shape optimization by minimizing intrinsically geometric fairness functionals [5, 12].

Whenever it comes to involved numerical computations on free form surfaces — for instance in finite element analysis of shells — the geometry is usually sampled at discrete locations and converted into a piecewise linear approximation, i.e., into a polygonal mesh.

Between these two opposite poles, i.e., the *continuous* representation of geometric shapes by spline patches and the *discrete* representation by polygonal meshes, there is a compromise emerging from the theory of *subdivision surfaces* [9]. Those surfaces are defined by a *base mesh* roughly describing its shape, and a *refinement rule* that allows one to split the edges and faces in order to obtain a finer and smoother version of the mesh.

Subdivision schemes started as a generalization of *knot insertion* for uniform B-splines [11]. Consider a control mesh $[c_{i,j}]$ and the knot vectors $[u_i] = [ih_u]$ and $[v_i] = [ih_v]$ defining a tensor product B-spline surface \mathcal{S} . The same surface can be given with respect to the refined knot vectors $[\hat{u}_i] = [ih_u/2]$ and $[\hat{v}_i] = [ih_v/2]$ by computing the corresponding control vertices $[\hat{c}_{i,j}]$, each $\hat{c}_{i,j}$ being a simple linear combination of original vertices $c_{i,j}$. It is well known that the iterative repetition of this process generates a sequence of meshes C_m which converges to the spline surface \mathcal{S} itself.

The generic subdivision paradigm generalizes this concept by allowing arbitrary rules for the computation of the new control vertices $\hat{c}_{i,j}$ from the given $c_{i,j}$. The generalization also includes that we are no longer restricted to tensor product meshes but can use rules that are adapted to the different topological special cases in meshes with arbitrary connectivity. As a consequence, we can use any (manifold) mesh for the base mesh and generate smooth surfaces by iterative refinement.

The major challenge is to find appropriate rules that guarantee the convergence of the meshes C_m generated during the subdivision process to a smooth limit surface $\mathcal{S} = C_\infty$. Besides the classical

stationary schemes that exploit the piecewise regular structure of iteratively refined meshes [2, 4, 9], there are more complex geometric schemes [15, 8] that combine the subdivision paradigm with the concept of optimal design by energy minimization (*fairing*).

The technical and practical advantages provided by the representation of surfaces in the form of polygonal meshes stem from the fact that we do not have to worry about infinitesimal inter-patch smoothness and the refinement rules do not have to rely on the existence of a globally consistent parameterization of the surface. In contrast to this, spline based approaches have to introduce complicated non-linear geometric continuity conditions to achieve the flexibility to model closed surfaces of arbitrary shape. This is due to the topologically rather rigid structure of patches with triangular or quadrilateral parameter domain and fixed polynomial degree of cross boundary derivatives. The non-linearity of such conditions makes efficient optimization difficult if not practically impossible. On discrete meshes however, we can derive *local* interpolants according to local parameterizations (*charts*) which gives the freedom to adapt the parameterization individually to the local geometry and topology.

In the following we will shortly describe the concept of *discrete fairing* which is an efficient way to characterize and compute dense point sets on high quality surfaces that observe prescribed interpolation or approximation constraints. We then show how this approach can be exploited in several relevant fields within the area of free form surface modeling.

The overall objective behind all the applications will be the attempt to avoid, bypass, or at least delay the mathematically involved generation of spline CAD-models whenever it is appropriate. Especially in the early design stages it is usually not necessary to have an explicit parameterization of a surface. The focus on polygonal mesh representations might help to free the creative designer from being confined by mathematical restrictions. In later stages the conversion into a spline model can be based on more reliable information about the intended shape. Moreover, since technical engineers are used to performing numerical simulations on polygonal approximations of the true model anyway, we also might find short-cuts that allow to speed up the turn-around cycles in the design process, e.g., we could alter the shape of a mechanical part by modifying the FE-mesh directly without converting back and forth between different CAD-models.

2.2 Fairing triangular meshes

The observation that in many applications the global fairness of a surface is much more important than infinitesimal smoothness motivates the *discrete fairing* approach [10]. Instead of requiring G^1 or G^2 continuity, we simply approximate a surface by a plain triangular C^0 -mesh. On such a mesh we can think of the (discrete) curvature being located at the vertices. The term *fairing* in this context means to minimize these local contributions to the total (discrete) curvature and to equalize their distribution across the mesh.

We approximate local curvatures at every vertex \mathbf{p} by divided differences with respect to a locally isometric parameterization $\mu_{\mathbf{p}}$. This parameterization can be found by estimating a tangent plane $T_{\mathbf{p}}$ (or the normal vector $\mathbf{n}_{\mathbf{p}}$) at \mathbf{p} and projecting the neighboring vertices \mathbf{p}_j into that plane. The projected points yield the parameter values (u_i, v_i) if represented with respect to an orthonormal basis $\{\mathbf{e}_u, \mathbf{e}_v\}$ spanning the tangent plane

$$\mathbf{p}_i - \mathbf{p} = u_i \mathbf{e}_u + v_i \mathbf{e}_v + d_i \mathbf{n}_{\mathbf{p}}.$$

Another possibility is to assign parameter values according to the lengths and the angles between adjacent edges (*discrete exponential*

map) [15, 10].

To obtain reliable curvature information at \mathbf{p} , i.e., second order partial derivatives with respect to the locally isometric parameterization $\mu_{\mathbf{p}}$, we solve the normal equation of the Vandermonde system

$$V^T V \left[\frac{1}{2} f_{uu}, f_{uv}, \frac{1}{2} f_{vv} \right]^T = V^T [d_i]_i$$

with $V = [u_i^2, u_i v_i, v_i^2]_i$ by which we get the best approximating quadratic polynomial in the least squares sense. The rows of the inverse matrix $(V^T V)^{-1} V^T =: [\alpha_{i,j}]$ by which the Taylor coefficients f_* of this polynomial are computed from the data $[d_i]_i$, contain the coefficients of the corresponding divided difference operators Γ_* .

Computing a weighted sum of the squared divided differences is equivalent to the discrete sampling of the corresponding continuous fairness functional. Consider for example

$$\int_S \kappa_1^2 + \kappa_2^2 dS$$

which is approximated by

$$\sum_{\mathbf{p}_i} \omega_i \left(\|\Gamma_{uu}(\mathbf{p}_j - \mathbf{p}_i)\|^2 + 2\|\Gamma_{uv}(\mathbf{p}_j - \mathbf{p}_i)\|^2 + \|\Gamma_{vv}(\mathbf{p}_j - \mathbf{p}_i)\|^2 \right). \quad (10)$$

Notice that the value of (10) is independent of the particular choices $\{\mathbf{e}_u, \mathbf{e}_v\}$ for each vertex due to the rotational invariance of the functional. The discrete fairing approach can be understood as a generalization of the traditional finite difference method to parametric meshes where divided difference operators are defined with respect to locally varying parameterizations. In order to make the weighted sum (10) of local curvature values a valid quadrature formula, the weights ω_i have to reflect the local area element which can be approximated by observing the relative sizes of the parameter triangles in the local charts $\mu_{\mathbf{p}} : \mathbf{p}_i \mapsto (u_i, v_i)$.

Since the objective functional (10) is made up of a sum over squared local linear combinations of vertices (in fact, of vertices being direct neighbors of one central vertex), the minimum is characterized by the solution of a global but sparse linear system. The rows of this system are the partial derivatives of (10) with respect to the movable vertices \mathbf{p}_i . Efficient algorithms are known for the solution of such systems [6].

2.3 Applications to free form surface design

When generating fair surfaces from scratch we usually prescribe a set of interpolation and approximation constraints and fix the remaining degrees of freedom by minimizing an energy functional. In the context of discrete fairing the constraints are given by an initial triangular mesh whose vertices are to be approximated by a fair surface being topologically equivalent. The necessary degrees of freedom for the optimization are obtained by uniformly subdividing the mesh and thus introducing new *movable* vertices.

The discrete fairing algorithm requires the definition of a local parameterization $\mu_{\mathbf{p}}$ for each vertex \mathbf{p} including the newly inserted ones. However, projection into an estimated tangent plane does not work here, because the final positions of the new vertices are obviously not known a priori. In [10] it has been pointed out that in order to ensure solvability and stability of the resulting linear system, it is appropriate to define the local parameterizations (local metrics) for the new vertices by *blending* the metrics of nearby vertices from the original mesh. Hence, we only have to estimate the local charts covering the original vertices to set-up the linear system which characterizes the optimal surface. This can be done prior to actually computing a solution and we omit an additional optimization loop over the parameterization.

When solving the sparse linear system by iterative methods we observe rather slow convergence. This is due to the low-pass filter characteristics of the iteration steps in a Gauß-Seidel or Jacobi scheme. However since the mesh on which the optimization is performed came out of a uniform refinement of the given mesh (*subdivision connectivity*) we can easily find nested grids which allow the application of highly efficient multi-grid schemes [6].

Moreover, in our special situation we can generate sufficiently smooth starting configurations by midpoint insertion which allows us to neglect the pre-smoothing phase and to reduce the V-cycle of the multi-grid scheme to the alternation of binary subdivision and iterative smoothing. The resulting algorithm has linear complexity in the number of generated triangles.

The advantage of this discrete approach compared to the classical fair surface generation based on spline surfaces is that we do not have to approximate a geometric functional that uses true curvatures by one which replaces those by second order partial derivatives with respect to the fixed parameterization of the patches. Since we can use a custom tailored parameterization for each point evaluation of the second order derivatives, we can choose this parameterization to be isometric — giving us access to the true geometric functional.

Figure 4 shows an example of a surface generated this way. The implementation can be done very efficiently. The shown surface consists of about 50K triangles and has been generated on a SGI R10000 (195MHz) within 10 seconds. The scheme is capable of generating an arbitrarily dense set of points on the surface of minimal energy. It is worth to point out that the scheme works completely automatic: no manual adaption of any parameters is necessary, yet the scheme produces good surfaces for a wide range of input data.

2.4 Applications to interactive modeling

For subdivision schemes we can use any triangular mesh as a control mesh roughly describing the shape of an object to be modeled. The flexibility of the schemes with respect to the connectivity of the underlying mesh allows very intuitive modifications of the mesh. The designer can move the control vertices just like for Bezier-patches but she is no longer tied to the common restrictions on the connectivity which is merely a consequence of the use of tensor product spline bases.

When modeling an object by Bezier-patches, the control vertices are the handles to influence the shape and the de Casteljau algorithm associates the control mesh with a smooth surface patch. In our more general setting, the designer can work on an *arbitrary* triangle mesh and the connection to a smooth surface is provided by the discrete fairing algorithm. The advantages are that control vertices are interpolated which is a more intuitive interaction metaphor and the topology of the control structure can adapt to the shape of the object.

Figure 5 shows the model of a mannequin head. A rather coarse triangular mesh allows already to define the global shape of the head (left). If we add more control vertices in the areas where more detail is needed, i.e., around the eyes, the mouth and the ears, we can construct the complex surface at the far right. Notice how the discrete fairing scheme does not generate any artifacts in regions where the level of detail changes.

2.5 Applications to mesh smoothing

In the last sections we saw how the discrete fairing approach can be used to generate fair surfaces that interpolate the vertices of a given triangular mesh. A related problem is to smooth out high frequency noise from a given *detailed* mesh without further refinement. Consider a triangulated surface emerging for example from 3D laser scanning or iso-surface extraction out of CT volume data. Due to measurement errors, those surfaces usually show oscillations that do not stem from the original geometry.

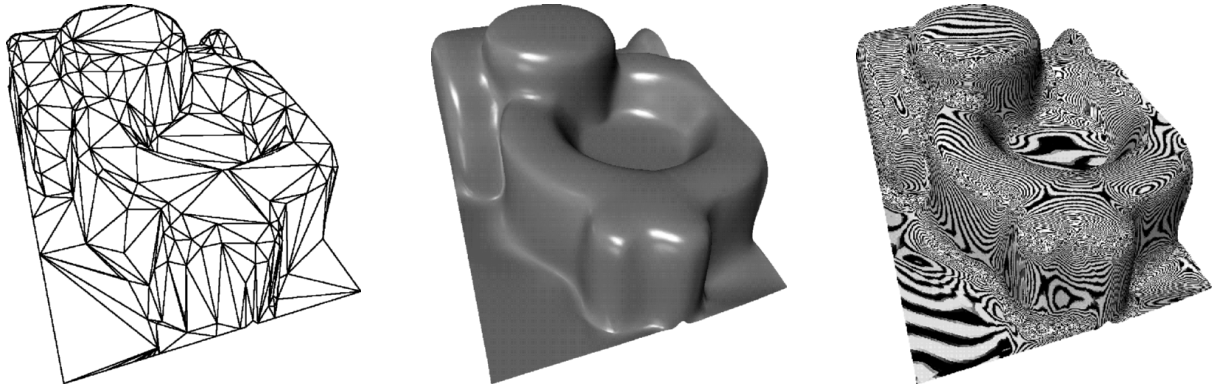

Figure 4: A fair surface generated by the discrete fairing scheme. The flexibility of the algorithm allows to interpolate rather complex data by high quality surfaces. The process is completely automatic and it took about 10 sec to compute the refined mesh with 50K triangles. On the right you see the reflection lines on the final surface.

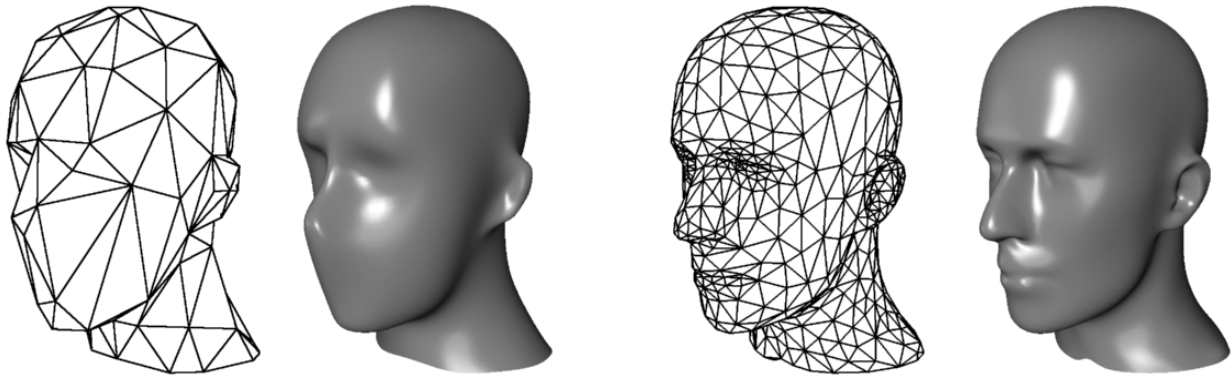

Figure 5: Control meshes with arbitrary connectivity allow to adapt the control structure to the geometry of the model. Notice that the influence of one control vertex in a tensor product mesh is always rectangular which makes it difficult to model shapes with non-rectangular features.

Constructing the above mentioned local parameterizations, we are able to quantify the noise by evaluating the local curvature. Shifting the vertices while observing a maximum tolerance can reduce the total curvature and hence smooth out the surface. From a signal processing point of view, we can interpret the iterative solving steps for the global sparse system as the application of recursive digital low-pass filters [13]. Hence it is obvious that the process will reduce the high frequency noise while maintaining the low frequency shape of the object.

Figure 6 shows an iso-surface extracted from a CT scan of an engine block. The noise is due to inexact measurement and instabilities in the extraction algorithm. The smoothed surface remains within a tolerance which is of the same order of magnitude as the diagonal of one voxel in the CT data.

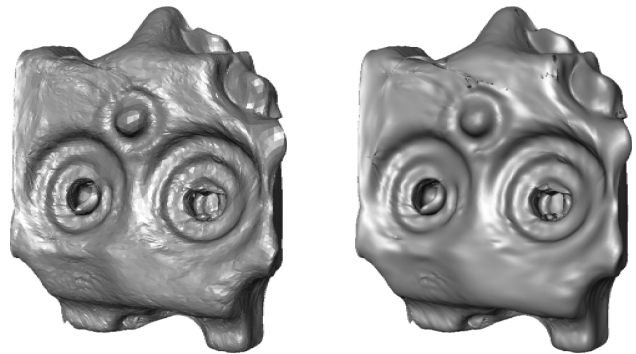

Figure 6: An iso-surface extracted from a CT scan of an engine block. On the left, one can clearly see the noise artifacts due to measurement and rounding errors. The right object was smoothed by minimizing the discrete fairing energy. Constraints on the positional delocation were imposed.

2.6 Applications to surface interrogation

Deriving curvature information on a discrete mesh is not only useful for fair interpolation or post-processing of measured data. It can also be used to visualize artifacts on a surface by plotting the color coded discrete curvature directly on the mesh. Given for example the output of the numerical simulation of a physical process: since deformation has occurred during the simulation, this output typically consists merely of a discrete mesh and no continuous surface description is available.

Using classical techniques from differential geometry would require to fit an interpolating spline surface to the data and then visualize the surface quality by curvature plots. The availability of

samples of second order partial derivatives with respect to locally isometric parameterizations at every vertex enables us to show this information directly without the need for a continuous surface.

Figure 7 shows a mesh which came out of the FE-simulation of a loaded cylindrical shell. The shell is clamped at the boundaries and pushed down by a force in normal direction at the center. The deformation induced by this load is rather small and cannot be detected by looking, e.g., at the reflection lines. The discrete mean curvature plot however clearly reveals the deformation. Notice that histogram equalization has been used to optimize the color contrast of the plot.

2.7 Applications to hole filling and blending

Another area where the discrete fairing approach can help is the filling of undefined regions in a CAD model or in a measured data set. Of course, all these problems can be solved by fairing schemes based on spline surfaces as well. However, the discrete fairing approach allows one to split the overall (quite involved) task into simple steps: we always start by constructing a triangle mesh defining the global topology. This is easy because no G^1 or higher boundary conditions have to be satisfied. Then we can apply the discrete fairing algorithm to generate a sufficiently dense point set on the objective surface. This part includes the refinement and energy minimization but it is almost completely automatic and does not have to be adapted to the particular application. In a last step we fit polynomial patches to the refined data. Here we can restrict ourselves to pure fitting since the fairing part has already been taken care of during the generation of the dense data. In other words, the discrete fairing has recovered enough information about an optimal surface such that staying as close as possible to the generated points (in a least squares sense) is expected to lead to high quality surfaces. To demonstrate this methodology we give two simple examples.

First, consider the point data in Figure 8. The very sparsely scattered points in the middle region make the task of interpolation rather difficult since the least squares matrix for a locally supported B-spline basis might become singular. To avoid this, fairing terms would have to be included into the objective functional. This however brings back all the problems mentioned earlier concerning the possibly poor quality of parameter dependent energy functionals and the prohibitive complexity of non-linear optimization.

Alternatively, we can connect the points to build a spatial triangulation. Uniform subdivision plus discrete fairing recovers the missing information under the assumption that the original surface was sufficiently fair. The un-equal distribution of the measured data points and the strong distortion in the initial triangulation do not cause severe instabilities since we can define individual parameterizations for every vertex. These allow one to take the local geometry into account.

Another standard problem in CAD is the *blending* or *filleting* between surfaces. Consider the simple configuration in Figure 9 where several plane faces (dark grey) are to be connected smoothly. We first close the gap by a simple coarse triangular mesh. Such a mesh can easily be constructed for any reasonable configuration with much less effort than constructing a piecewise polynomial representation. The boundary of this initial mesh is obtained by sampling the surfaces to be joined.

We then refine the mesh and, again, apply the discrete fairing machinery. The smoothness of the connection to the predefined parts of the geometry is guaranteed by letting the blend surface mesh overlap with the given faces by one row of triangles (all necessary information is obtained by sampling the given surfaces). The vertices of the triangles belonging to the original geometry are not allowed to move but since they participate in the global fairness functional they enforce a smooth connection. In fact this technique allows to define Hermite-type boundary conditions.

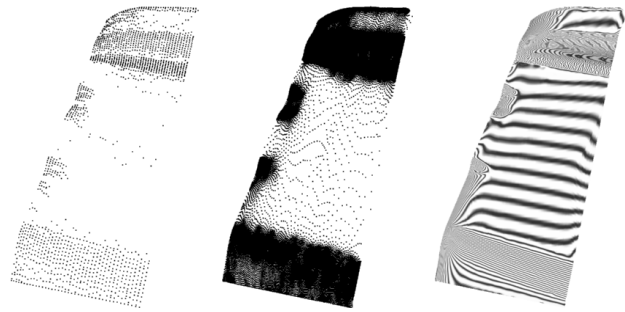

Figure 8: The original data on the left is very sparse in the middle region of the object. Triangulating the points in space and discretely fairing the iteratively refined mesh recovers more information which makes least squares approximation much easier. On the right, reflection lines on the resulting surface are shown.

2.8 Conclusion

In this paper we gave a survey of currently implemented applications of the discrete fairing algorithm. This general technique can be used in all areas of CAD/CAM where an approximation of the actual surface by a reasonably fine triangular mesh is a sufficient representation. If compatibility to standard CAD formats matters, a spline fitting post-process can always conclude the discrete surface generation or modification. This fitting step can rely on more information about the intended shape than was available in the original setting since a *dense* set of points has been generated.

As we showed in the previous sections, mesh smoothing and hole filling can be done on the discrete structure *before* switching to a continuous representation. Hence, the bottom line of this approach is to do most of the work in the discrete setting such that the mathematically more involved algorithms to generate piecewise polynomial surfaces can be applied to enhanced input data with most common artifacts removed.

We do not claim that splines could ever be completely replaced by polygonal meshes but in our opinion we can save a considerable amount of effort if we use spline models only where it is really necessary and stick to meshes whenever it is possible. There seems to be a huge potential of applications where meshes do the job if we find efficient algorithms.

The major key to cope with the genuine complexity of highly detailed triangle meshes is the introduction of a hierarchical structure. Hierarchies could emerge from classical multi-resolution techniques like subdivision schemes but could also be a by-product of mesh simplification algorithms.

An interesting issue for future research is to find efficient and numerically stable methods to enforce convexity preservation in the fairing scheme. At least local convexity can easily be maintained by introducing non-linear constraints at the vertices.

Prospective work also has to address the investigation of explicit and reliable techniques to exploit the discrete curvature information for the detection of feature lines in the geometry in order to split a given mesh into geometrically coherent segments. Further, we can try to identify regions of a mesh where the value of the curvature is approximately constant — those regions correspond to special geometries like spheres, cylinders or planes. This will be the topic of a forthcoming paper.

References

- [1] E. Catmull, J. Clark, *Recursively generated B-spline surfaces on arbitrary topological meshes*, CAD 10 (1978), pp. 350–355

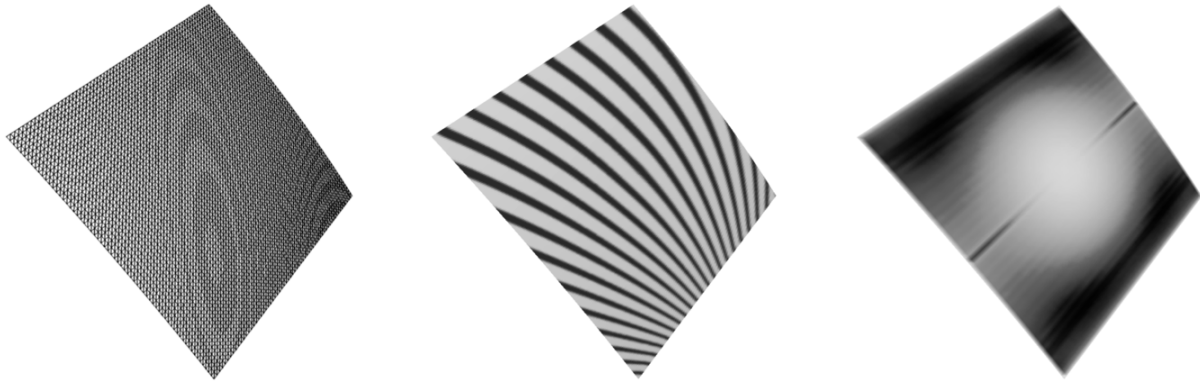

Figure 7: Visualizing the discrete curvature on a finite element mesh allows to detect artifacts without interpolating the data by a continuous surface.

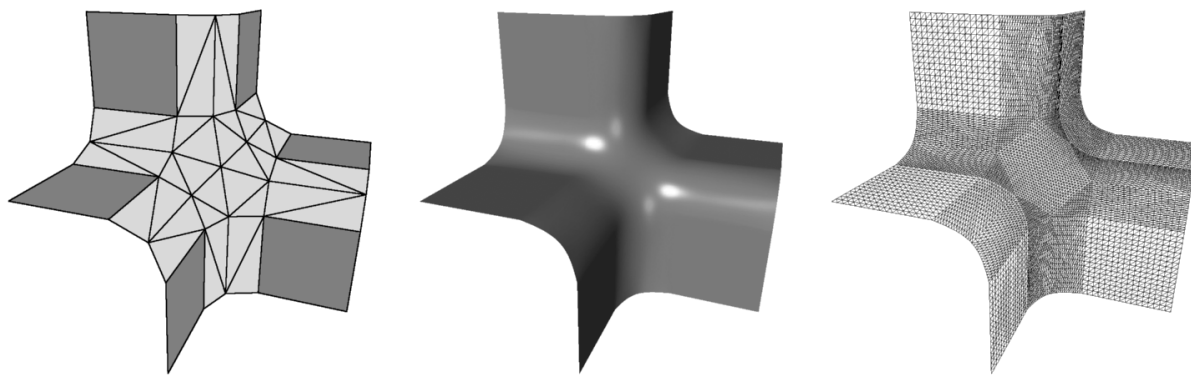

Figure 9: Creating a “monkey saddle” blend surface to join six planes. Any blend surface can be generated by closing the gap with a triangular mesh first and then applying discrete fairing.

- [2] Celniker G. and D. Gossard, *Deformable curve and surface finite elements for free-form shape design*, ACM Computer Graphics **25** (1991), 257–265.
- [3] D. Doo and M. Sabin, *Behaviour of Recursive Division Surfaces Near Extraordinary Points*, CAD **10** (1978), pp. 356–360
- [4] N. Dyn, *Subdivision Schemes in Computer Aided Geometric Design*, Adv. Num. Anal. II, Wavelets, Subdivisions and Radial Functions, W.A. Light ed., Oxford Univ. Press, 1991, pp. 36–104.
- [5] Greiner G., *Variational design and fairing of spline surfaces*, Computer Graphics Forum **13** (1994), 143–154.
- [6] Hackbusch W., *Multi-Grid Methods and Applications*, Springer Verlag 1985, Berlin.
- [7] Hagen H. and G. Schulze, *Automatic smoothing with geometric surface patches*, CAGD **4** (1987), 231–235.
- [8] Kobbelt L., *A variational approach to subdivision*, CAGD **13** (1996), 743–761.
- [9] Kobbelt L., *Interpolatory subdivision on open quadrilateral nets with arbitrary topology*, Comp. Graph. Forum **15** (1996), 409–420.
- [10] Kobbelt L., *Discrete fairing*, Proceedings of the Seventh IMA Conference on the Mathematics of Surfaces, 1997, pp. 101–131.
- [11] J. Lane and R. Riesenfeld, *A Theoretical Development for the Computer Generation and Display of Piecewise Polynomial Surfaces*, IEEE Trans. on Pattern Anal. and Mach. Int., **2** (1980), pp. 35–46
- [12] Moreton H. and C. Séquin, *Functional optimization for fair surface design*, ACM Computer Graphics **26** (1992), 167–176.
- [13] Taubin G., *A signal processing approach to fair surface design*, ACM Computer Graphics **29** (1995), 351–358
- [14] Welch W. and A. Witkin, *Variational surface modeling*, ACM Computer Graphics **26** (1992), 157–166
- [15] Welch W. and A. Witkin, *Free-form shape design using triangulated surfaces*, ACM Computer Graphics **28** (1994), 247–256

Chapter 9

Parameterization, remeshing, and compression using subdivision

Speaker: Wim Sweldens

MAPS: Multiresolution Adaptive Parameterization of Surfaces

Aaron W. F. Lee*
Princeton University

Wim Sweldens†
Bell Laboratories

Peter Schröder‡
Caltech

Lawrence Cowsar§
Bell Laboratories

David Dobkin¶
Princeton University

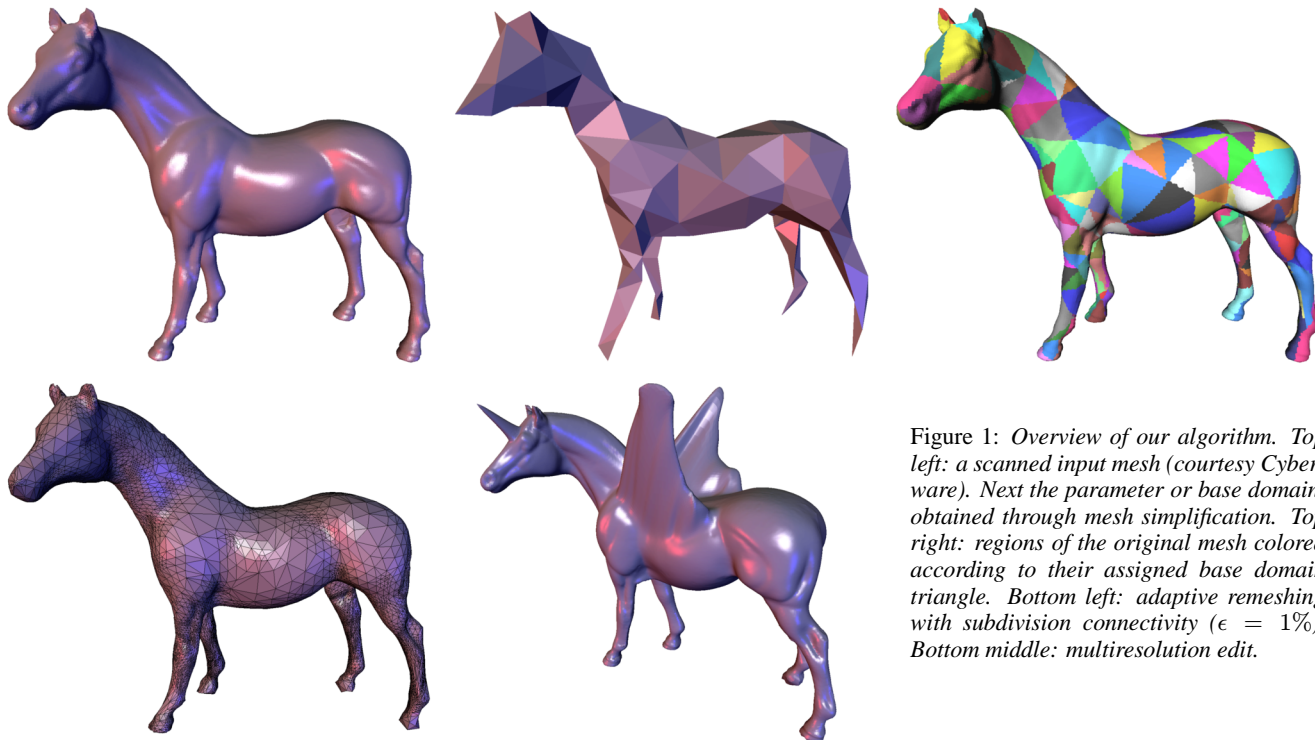

Figure 1: Overview of our algorithm. Top left: a scanned input mesh (courtesy Cyberware). Next the parameter or base domain, obtained through mesh simplification. Top right: regions of the original mesh colored according to their assigned base domain triangle. Bottom left: adaptive remeshing with subdivision connectivity ($\epsilon = 1\%$). Bottom middle: multiresolution edit.

Abstract

We construct smooth parameterizations of irregular connectivity triangulations of arbitrary genus 2-manifolds. Our algorithm uses hierarchical simplification to efficiently induce a parameterization of the original mesh over a base domain consisting of a small number of triangles. This initial parameterization is further improved through a hierarchical smoothing procedure based on Loop subdivision applied in the parameter domain. Our method supports both fully automatic and user constrained operations. In the latter, we accommodate point and edge constraints to force the align-

ment of iso-parameter lines with desired features. We show how to use the parameterization for fast, hierarchical subdivision connectivity remeshing with guaranteed error bounds. The remeshing algorithm constructs an adaptively subdivided mesh directly without first resorting to uniform subdivision followed by subsequent sparsification. It thus avoids the exponential cost of the latter. Our parameterizations are also useful for texture mapping and morphing applications, among others.

CR Categories and Subject Descriptors: I.3.3 [Computer Graphics]: *Picture/Image Generation – Display Algorithms, Viewing Algorithms*; I.3.5 [Computer Graphics]: *Computational Geometry and Object Modeling - Curve, Surface, Solid and Object Representations, Hierarchy and Geometric Transformations, Object Hierarchies*.

Additional Key Words and Phrases: Meshes, surface parameterization, mesh simplification, remeshing, texture mapping, multiresolution, subdivision surfaces, Loop scheme.

1 Introduction

Dense triangular meshes routinely result from a number of 3D acquisition techniques, e.g., laser range scanning and MRI volumetric imaging followed by iso-surface extraction (see Figure 1 top left). The triangulations form a surface of arbitrary topology—genus, boundaries, connected components—and have irregular connectivity. Because of their complex structure and tremendous size, these meshes are awkward to handle in such common tasks as storage, display, editing, and transmission.

*wailee@cs.princeton.edu

†wim@bell-labs.com

‡ps@cs.caltech.edu

§cowsar@bell-labs.com

¶dpd@cs.princeton.edu

Multiresolution representations are now established as a fundamental component in addressing these issues. Two schools exist. One approach extends classical multiresolution analysis and subdivision techniques to arbitrary topology surfaces [19, 20, 7, 3]. The alternative is more general and is based on sequential mesh simplification, e.g., progressive meshes (PM) [12]; see [11] for a review. In either case, the objective is to represent triangulated 2-manifolds in an efficient and flexible way, and to use this description in fast algorithms addressing the challenges mentioned above. Our approach fits in the first group, but draws on ideas from the second group.

An important element in the design of algorithms which manipulate mesh approximations of 2-manifolds is the construction of “nice” parameterizations when none are given. Ideally, the manifold is parameterized over a base domain consisting of a small number of triangles. Once a surface is understood as a function from the base domain into \mathbf{R}^3 (or higher-D when surface attributes are considered), many tools from areas such as approximation theory, signal processing, and numerical analysis are at our disposal. In particular, classical multiresolution analysis can be used in the design and analysis of algorithms. For example, error controlled, adaptive remeshing can be performed easily and efficiently. Figure 1 shows the outline of our procedure: beginning with an irregular input mesh (top left), we find a base domain through mesh simplification (top middle). Concurrent with simplification, a mapping is constructed which assigns every vertex from the original mesh to a base triangle (top right). Using this mapping an adaptive remesh with subdivision connectivity can be built (bottom left) which is now suitable for such applications as multiresolution editing (bottom middle). Additionally, there are other practical payoffs to good parameterizations, for example in texture mapping and morphing.

In this paper we present an algorithm for the fast computation of smooth parameterizations of dense 2-manifold meshes with arbitrary topology. Specifically, we make the following contributions

- We describe an $O(N \log N)$ time and storage algorithm to construct a logarithmic level hierarchy of arbitrary topology, irregular connectivity meshes based on the Dobkin-Kirkpatrick (DK) algorithm. Our algorithm accommodates geometric criteria such as area and curvature as well as vertex and edge constraints.
- We construct a smooth parameterization of the original mesh over the base domain. This parameterization is derived through repeated conformal remapping during graph simplification followed by a parameter space smoothing procedure based on the Loop scheme. The resulting parameterizations are of high visual and numerical quality.
- Using the smooth parameterization, we describe an algorithm for adaptive, hierarchical remeshing of arbitrary meshes into subdivision connectivity meshes. The procedure is fully automatic, but also allows for user intervention in the form of fixing point or path features in the original mesh. The remeshed manifold meets conservative approximation bounds.

Even though the ingredients of our construction are reminiscent of mesh simplification algorithms, we emphasize that our goal is not the construction of another mesh simplification procedure, but rather the construction of smooth parameterizations. We are particularly interested in using these parameterizations for remeshing, although they are useful for a variety of applications.

1.1 Related Work

A number of researchers have considered—either explicitly or implicitly—the problem of building parameterizations for arbitrary topology, triangulated surfaces. This work falls into two main categories: (1) algorithms which build a smoothly parameterized ap-

proximation of a set of samples (e.g. [14, 1, 17]), and (2) algorithms which remesh an existing mesh with the goal of applying classical multiresolution approaches [7, 8].

A related, though quite different problem, is the maintenance of a *given* parameterization during mesh simplification [4]. We emphasize that our goal is the *construction* of mappings when none are given.

In the following two sections, we discuss related work and contrast it to our approach.

1.1.1 Approximation of a Given Set of Samples

Hoppe and co-workers [14] describe a fully automatic algorithm to approximate a given polyhedral mesh with Loop subdivision patches [18] respecting features such as edges and corners. Their algorithm uses a non-linear optimization procedure taking into account approximation error and the number of triangles of the base domain. The result is a smooth parameterization of the original polyhedral mesh over the base domain. Since the approach only uses subdivision, small features in the original mesh can only be resolved accurately by increasing the number of triangles in the base domain accordingly. A similar approach, albeit using A-patches, was described by Bajaj and co-workers [1]. From the point of view of constructing parameterizations, the main drawback of algorithms in this class is that the number of triangles in the base domain depends heavily on the geometric complexity of the goal surface.

This problem was addressed in work of Krishnamurthy and Levoy [17]. They approximate densely sampled geometry with bicubic spline patches and displacement maps. Arguing that a fully automatic system cannot put iso-parameter lines where a skilled animator would want them, they require the user to lay out the entire network of top level spline patch boundaries. A coarse to fine matching procedure with relaxation is used to arrive at a high quality patch mesh whose base domain need not mimic small scale geometric features.

The principal drawback of their procedure is that the user is required to define the *entire* base domain rather than only selected features. Additionally, given that the procedure works from coarse to fine, it is possible for the procedure to “latch” onto the wrong surface in regions of high curvature [17, Figure 7].

1.1.2 Remeshing

Lounsbery and co-workers [19, 20] were the first to propose algorithms to extend classical multiresolution analysis to arbitrary topology surfaces. Because of its connection to the mathematical foundations of wavelets, this approach has proven very attractive (e.g. [22, 7, 27, 8, 3, 28]). The central requirement of these methods is that the input mesh have subdivision connectivity. This is generally not true for meshes derived from 3D scanning sources.

To overcome this problem, Eck and co-workers [7] developed an algorithm to compute smooth parameterizations of high resolution polyhedral meshes over a low face count base domain. Using such a mapping, the original surface can be remeshed using subdivision connectivity. After this conversion step, adaptive simplification, compression, progressive transmission, rendering, and editing become simple and efficient operations [3, 8, 28].

Eck et al. arrive at the base domain through a Voronoi tiling of the original mesh. Using a sequence of local harmonic maps, a parameterization which is smooth over each triangle in the base domain and which meets with C^0 continuity at base domain edges [7, Plate 1(f)] is constructed. Runtimes for the algorithm can be long because of the many harmonic map computations. This problem was recently addressed by Duchamp and co-workers [6], who reduced the harmonic map computations from their initial $O(N^2)$ complexity to $O(N \log N)$ through hierarchical preconditioning. The hier-

archy construction they employed for use in a multigrid solver is related to our hierarchy construction.

The initial Voronoi tile construction relies on a number of heuristics which render the overall algorithm fragile (for an improved version see [16]). Moreover, there is no explicit control over the number of triangles in the base domain or the placement of patch boundaries.

The algorithm generates only uniformly subdivided meshes which later can be decimated through classical wavelet methods. Many extra globally subdivided levels may be needed to resolve one small local feature; moreover, each additional level quadruples the amount of work and storage. This can lead to the intermediate construction of many more triangles than were contained in the input mesh.

1.2 Features of MAPS

Our algorithm was designed to overcome the drawbacks of previous work as well as to introduce new features. We use a fast coarsification strategy to define the base domain, avoiding the potential difficulties of finding Voronoi tiles [7, 16]. Since our algorithm proceeds from fine to coarse, correspondence problems found in coarse to fine strategies [17] are avoided, and all features are correctly resolved. We use conformal maps for continued remapping during coarsification to immediately produce a global parameterization of the original mesh. This map is further improved through the use of a hierarchical Loop smoothing procedure obviating the need for iterative numerical solvers [7]. Since the procedure is performed globally, derivative discontinuities at the edges of the base domain are avoided [7]. In contrast to fully automatic methods [7], the algorithm supports vertex and edge tags [14] to constrain the parameterization to align with selected features; however, the user is not required to specify the entire patch network [17]. During remeshing we take advantage of the original fine to coarse hierarchy to output a sparse, adaptive, subdivision connectivity mesh directly without resorting to a depth first oracle [22] or the need to produce a uniform subdivision connectivity mesh at exponential cost followed by wavelet thresholding [3].

2 Hierarchical Surface Representation

In this section we describe the main components of our algorithm, coarsification and map construction. We begin by fixing our notation.

2.1 Notation

When describing surfaces mathematically, it is useful to separate the topological and geometric information. To this end we introduce some notation adapted from [24]. We denote a triangular mesh as a pair $(\mathcal{P}, \mathcal{K})$, where \mathcal{P} is a set of N point positions $p_i = (x_i, y_i, z_i) \in \mathbf{R}^3$ with $1 \leq i \leq N$, and \mathcal{K} is an *abstract simplicial complex* which contains all the topological, i.e., adjacency information. The complex \mathcal{K} is a set of subsets of $\{1, \dots, N\}$. These subsets are called simplices and come in 3 types: vertices $v = \{i\} \in \mathcal{K}$, edges $e = \{i, j\} \in \mathcal{K}$, and faces $f = \{i, j, k\} \in \mathcal{K}$, so that any non-empty subset of a simplex of \mathcal{K} is again a simplex of \mathcal{K} , e.g., if a face is present so are its edges and vertices.

Let e_i denote the standard i -th basis vector in \mathbf{R}^N . For each simplex s , its *topological realization* $|s|$ is the strictly convex hull of $\{e_i \mid i \in s\}$. Thus $|\{i\}| = e_i$, $|\{i, j\}|$ is the open line segment between e_i and e_j , and $|\{i, j, k\}|$ is an open equilateral triangle. The topological realization $|\mathcal{K}|$ is defined as $\cup_{s \in \mathcal{K}} |s|$. The *geometric realization* $\varphi(|\mathcal{K}|)$ relies on a linear map $\varphi : \mathbf{R}^N \rightarrow \mathbf{R}^3$ defined

by $\varphi(e_i) = p_i$. The resulting polyhedron consists of points, segments, and triangles in \mathbf{R}^3 .

Two vertices $\{i\}$ and $\{j\}$ are *neighbors* if $\{i, j\} \in \mathcal{K}$. A set of vertices is *independent* if no two vertices are neighbors. A set of vertices is *maximally independent* if no larger independent set contains it (see Figure 3, left side). The 1-ring neighborhood of a vertex $\{i\}$ is the set

$$\mathcal{N}(i) = \{j \mid \{i, j\} \in \mathcal{K}\}.$$

The *outdegree* K_i of a vertex is its number of neighbors. The *star* of a vertex $\{i\}$ is the set of simplices

$$\text{star}(i) = \bigcup_{i \in s, s \in \mathcal{K}} s.$$

We say that $|K|$ is a two dimensional manifold (or 2-manifold) with boundaries if for each i , $|\text{star}(i)|$ is homeomorphic to a disk (interior vertex) or half-disk (boundary vertex) in \mathbf{R}^2 . An edge $e = \{i, j\}$ is called a *boundary edge* if there is only one face f with $e \subset f$.

We define a conservative curvature estimate, $\kappa(i) = |\kappa_1| + |\kappa_2|$ at p_i , using the principal curvatures κ_1 and κ_2 . These are estimated by the standard procedure of first establishing a tangent plane at p_i and then using a second degree polynomial to approximate $\varphi(|\text{star}(i)|)$.

2.2 Mesh Hierarchies

An important part of our algorithm is the construction of a mesh hierarchy. The original mesh $(\mathcal{P}, \mathcal{K}) = (\mathcal{P}^L, \mathcal{K}^L)$ is successively simplified into a series of homeomorphic meshes $(\mathcal{P}^l, \mathcal{K}^l)$ with $0 \leq l < L$, where $(\mathcal{P}^0, \mathcal{K}^0)$ is the coarsest or base mesh (see Figure 4).

Several approaches for such mesh simplification have been proposed, most notably progressive meshes (PM) [12]. In PM the basic operation is the “edge collapse.” A sequence of such atomic operations is prioritized based on approximation error. The linear sequence of edge collapses can be partially ordered based on topological dependence [25, 13], which defines levels in a hierarchy. The depth of these hierarchies appears “reasonable” in practice, though can vary considerably for the same dataset [13].

Our approach is similar in spirit, but inspired by the hierarchy proposed by Dobkin and Kirkpatrick (DK) [5], which guarantees that the number of levels L is $O(\log N)$. While the original DK hierarchy is built for convex polyhedra, we show how the idea behind DK can be used for general polyhedra. The DK atomic simplification step is a *vertex remove*, followed by a retriangulation of the hole.

The two basic operations “vertex remove” and “edge collapse” are related since an edge collapse into one of its endpoints corresponds to a vertex remove with a particular retriangulation of the resulting hole (see Figure 2). The main reason we chose an algorithm based on the ideas of the DK hierarchy is that it guarantees a logarithmic bound on the number of levels. However, we emphasize that the ideas behind our map constructions apply equally well to PM type algorithms.

2.3 Vertex Removal

One DK simplification step $\mathcal{K}^l \rightarrow \mathcal{K}^{l-1}$ consists of removing a maximally independent set of vertices with low outdegree (see Figure 3). To find such a set, the original DK algorithm used a greedy approach based only on *topological* information. Instead, we use a priority queue based on both *geometric and topological* information.

At the start of each level of the original DK algorithm, none of the vertices are marked and the set to be removed is empty. The

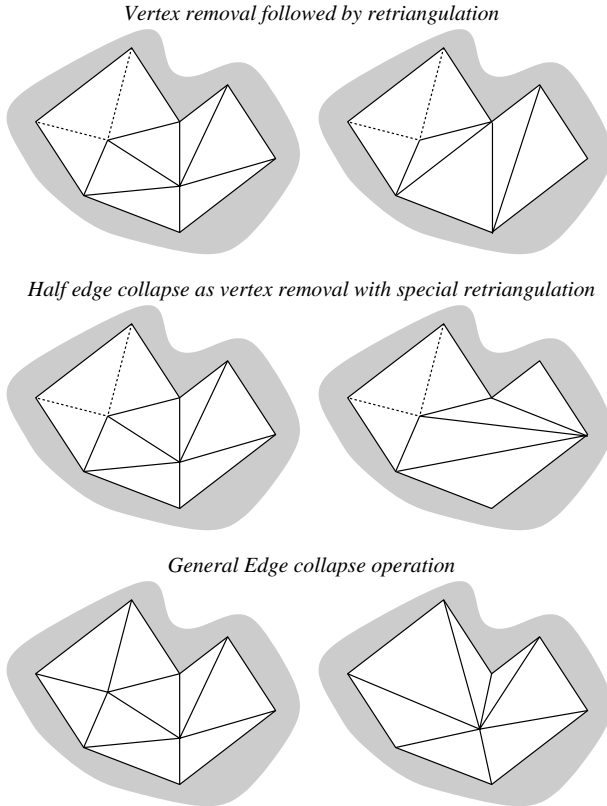

Figure 2: Examples of different atomic mesh simplification steps. At the top vertex removal, in the middle half-edge collapse, and edge collapse at the bottom.

algorithm randomly selects a non-marked vertex of outdegree less than 12, removes it and its star from \mathcal{K}^l , marks its neighbors as unremovable and iterates this until no further vertices can be removed. In a triangulated surface the average outdegree of a vertex is 6. Consequently, no more than half of the vertices can be of outdegree 12 or more. Thus it is guaranteed that at least $1/24$ of the vertices will be removed at each level [5]. In practice, it turns out one can remove roughly $1/4$ of the vertices reflecting the fact that the graph is four-colorable. Given that a constant fraction can be removed on each level, the number of levels behaves as $O(\log N)$. The entire hierarchy can thus be constructed in linear time.

In our approach, we stay in the DK framework, but replace the random selection of vertices by a priority queue based on geometric information. Roughly speaking, vertices with small and flat 1-ring neighborhoods will be chosen first. At level l , for a vertex $p_i \in \mathcal{P}^l$, we consider its 1-ring neighborhood $\varphi(|\text{star}(i)|)$ and compute its area $a(i)$ and estimate its curvature $\kappa(i)$. These quantities are computed relative to \mathcal{K}^l , the current level. We assign a priority to $\{i\}$ inversely proportional to a convex combination of relative area and curvature

$$w(\lambda, i) = \lambda \frac{a(i)}{\max_{p_i \in \mathcal{P}^l} a(i)} + (1 - \lambda) \frac{\kappa(i)}{\max_{p_i \in \mathcal{P}^l} \kappa(i)}.$$

(We found $\lambda = 1/2$ to work well in our experiments.) Omitting all vertices of outdegree greater than 12 from the queue, removal of a constant fraction of vertices is still guaranteed. Because of the sort implied by the priority queue, the complexity of building the entire hierarchy grows to $O(N \log N)$.

Figure 4 shows three stages (original, intermediary, coarsest) of the DK hierarchy. Given that the coarsest mesh is homeomorphic to the original mesh, it can be used as the domain of a parameterization.

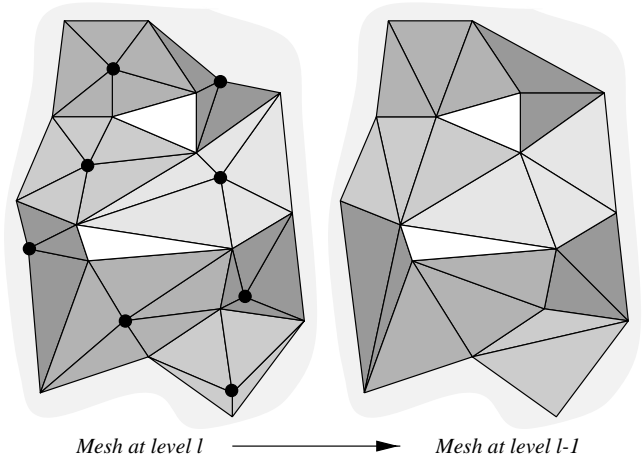

Figure 3: On the left a mesh with a maximally independent set of vertices marked by heavy dots. Each vertex in the independent set has its respective star highlighted. Note that the star's of the independent set do not tile the mesh (two triangles are left white). The right side gives the retriangulation after vertex removal.

2.4 Flattening and Retriangulation

To find \mathcal{K}^{l-1} , we need to retriangulate the holes left by removing the independent set. One possibility is to find a plane into which to project the 1-ring neighborhood $\varphi(|\text{star}(i)|)$ of a removed vertex $\varphi(|i|)$ without overlapping triangles and then retriangulate the hole in that plane. However, finding such a plane, which may not even exist, can be expensive and involves linear programming [4].

Instead, we use the conformal map z^a [6] which minimizes metric distortion to map the neighborhood of a removed vertex into the plane. Let $\{i\}$ be a vertex to be removed. Enumerate cyclically the K_i vertices in the 1-ring $\mathcal{N}(i) = \{j_k \mid 1 \leq k \leq K_i\}$ such that $\{j_{k-1}, i, j_k\} \in \mathcal{K}^l$ with $j_0 = j_{K_i}$. A piecewise linear approximation of z^a , which we denote by μ_i , is defined by its values for the center point and 1-ring neighbors; namely, $\mu_i(p_i) = 0$ and $\mu_i(p_{j_k}) = r_k^a \exp(i\theta_k a)$, where $r_k = \|p_i - p_{j_k}\|$,

$$\theta_k = \sum_{l=1}^k \angle(p_{j_{l-1}}, p_i, p_{j_l}),$$

and $a = 2\pi/\theta_{K_i}$. The advantages of the conformal map are numerous: it always exists, it is easy to compute, it minimizes metric distortion, and it is a bijection and thus never maps two triangles on top of each other. Once the 1-ring is flattened, we can retriangulate the hole using, for example, a constrained Delaunay triangulation (CDT) (see Figure 5). This tells us how to build \mathcal{K}^{l-1} .

When the vertex to be removed is a boundary vertex, we map to a half disk by setting $a = \pi/\theta_{K_i}$ (assuming j_1 and j_{K_i} are boundary vertices and setting $\theta_1 = 0$). Retriangulation is again performed with a CDT.

3 Initial Parameterization

To find a parameterization, we begin by constructing a bijection Π from $\varphi(|\mathcal{K}^L|)$ to $\varphi(|\mathcal{K}^0|)$. The parameterization of the original mesh over the base domain follows from $\Pi^{-1}(\varphi(|\mathcal{K}^0|))$. In other words, the mapping of a point $p \in \varphi(|\mathcal{K}^L|)$ through Π is a point $p^0 = \Pi(p) \in \varphi(|\mathcal{K}^0|)$, which can be written as

$$p^0 = \alpha p_i + \beta p_j + \gamma p_k,$$

where $\{i, j, k\} \in \mathcal{K}^0$ is a face of the base domain and α, β and γ are barycentric coordinates, i.e., $\alpha + \beta + \gamma = 1$.

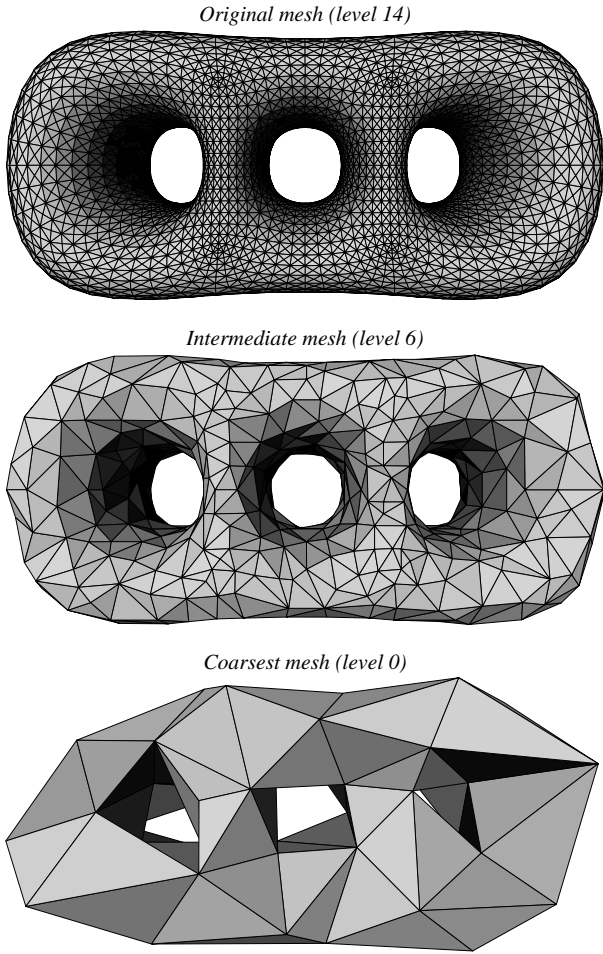

Figure 4: Example of a modified DK mesh hierarchy. At the top the finest (original) mesh $\varphi(|\mathcal{K}^L|)$ followed by an intermediate mesh, and the coarsest (base) mesh $\varphi(|\mathcal{K}^0|)$ at the bottom (original dataset courtesy University of Washington).

The mapping can be computed concurrently with the hierarchy construction. The basic idea is to successively compute piecewise linear bijections Π^l between $\varphi(|\mathcal{K}^L|)$ and $\varphi(|\mathcal{K}^l|)$ starting with Π^L , which is the identity, and ending with $\Pi^0 = \Pi$.

Notice that we only need to compute the value of Π^l at the vertices of \mathcal{K}^L . At any other point it follows from piecewise linearity.¹ Assume we are given Π^l and want to compute Π^{l-1} . Each vertex $\{i\} \in \mathcal{K}^L$ falls into one of the following categories:

1. $\{i\} \in \mathcal{K}^{l-1}$: The vertex is not removed on level l and survives on level $l-1$. In this case nothing needs to be done. $\Pi^{l-1}(p_i) = \Pi^l(p_i) = p_i$.
2. $\{i\} \in \mathcal{K}^l \setminus \mathcal{K}^{l-1}$: The vertex gets removed when going from l to $l-1$. Consider the flattening of the 1-ring around p_i (see Figure 5). After retriangulation, the origin lies in a triangle which corresponds to some face $t = \{j, k, m\} \in \mathcal{K}^{l-1}$ and has barycentric coordinates (α, β, γ) with respect to the vertices of that face, i.e., $\alpha \mu_i(p_j) + \beta \mu_i(p_k) + \gamma \mu_i(p_m)$ (see Figure 6). In that case, let $\Pi^{l-1}(p_i) = \alpha p_j + \beta p_k + \gamma p_m$.
3. $\{i\} \in \mathcal{K}^L \setminus \mathcal{K}^l$: The vertex was removed earlier, thus

¹In the vicinity of vertices in \mathcal{K}^l a triangle $\{i, j, k\} \in \mathcal{K}^L$ can straddle multiple triangles in \mathcal{K}^l . In this case the map depends on the flattening strategy used (see Section 2.4).

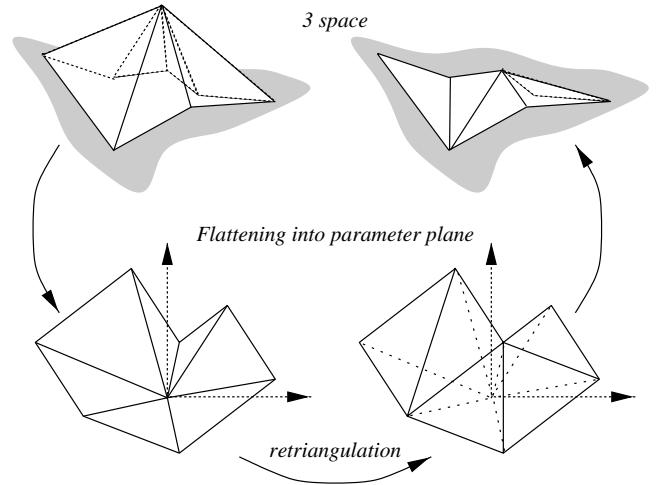

Figure 5: In order to remove a vertex p_i , its star (i) is mapped from 3-space to a plane using the map z^a . In the plane the central vertex is removed and the resulting hole retriangulated (bottom right).

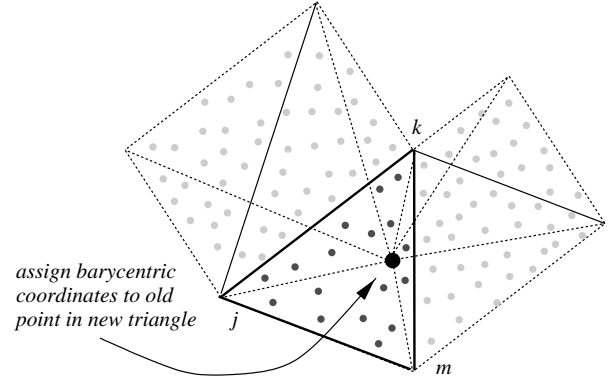

Figure 6: After retriangulation of a hole in the plane (see Figure 5), the just removed vertex gets assigned barycentric coordinates with respect to the containing triangle on the coarser level. Similarly, all the finest level vertices that were mapped to a triangle of the hole now need to be reassigned to a triangle of the coarser level.

$\Pi^l(p_i) = \alpha' p_{j'} + \beta' p_{k'} + \gamma' p_{m'}$ for some triangle $t' = \{j', k', m'\} \in \mathcal{K}^l$. If $t' \in \mathcal{K}^{l-1}$, nothing needs to be done; otherwise, the independent set guarantees that exactly one vertex of t' is removed, say $\{j'\}$. Consider the conformal map $\mu_{j'}$ (Figure 6). After retriangulation, the $\mu_{j'}(p_i)$ lies in a triangle which corresponds to some face $t = \{j, k, m\} \in \mathcal{K}^{l-1}$ with barycentric coordinates (α, β, γ) (black dots within highlighted face in Figure 6). In that case, let $\Pi^{l-1}(p_i) = \alpha p_j + \beta p_k + \gamma p_m$ (i.e., all vertices in Figure 6 are reparameterized in this way).

Note that on every level, the algorithm requires a sweep through all the vertices of the finest level resulting in an overall complexity of $O(N \log N)$.

Figure 7 visualizes the mapping we just computed. For each point p_i from the original mesh, its mapping $\Pi(p_i)$ is shown with a dot on the base domain.

Caution: Given that every association between a 1-ring and its retriangulated hole is a bijection, so is the mapping Π . However, Π does not necessarily map a finest level triangle to a triangular region in the base domain. Instead the image of a triangle may be a non-convex region. In that case connecting the mapped vertices with straight lines can cause flipping, i.e., triangles may end up on

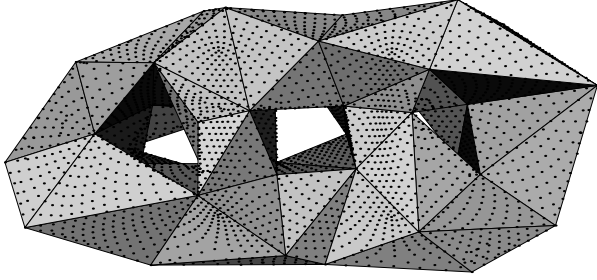

Figure 7: Base domain $\varphi(|\mathcal{K}^0|)$. For each point p_i from the original mesh, its mapping $\Pi(p_i)$ is shown with a dot on the base domain.

top of each other (see Figure 8 for an example). Two methods exist for dealing with this problem. First one could further subdivide the original mesh in the problem regions. Given that the underlying continuous map is a bijection, this is guaranteed to fix the problem. The alternative is to use some brute force triangle unflipping mechanism. We have found the following scheme to work well: adjust the parameter values of every vertex whose 2-neighborhood contains a flipped triangle, by replacing them with the averaged parameter values of its 1-ring neighbors [7].

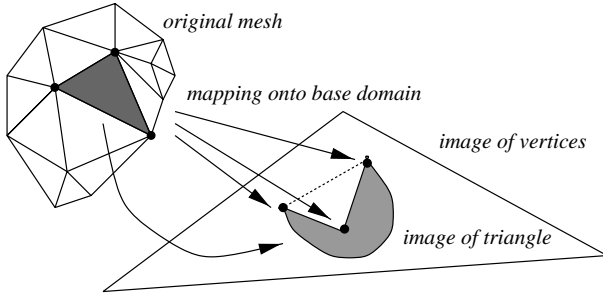

Figure 8: Although the mapping Π from the original mesh to a base domain triangle is a bijection, triangles do not in general get mapped to triangles. Three vertices of the original mesh get mapped to a concave configuration on the base domain, causing the piecewise linear approximation of the map to flip the triangle.

3.1 Tagging and Feature Lines

In the algorithm described so far, there is no *a priori* control over which vertices end up in the base domain or how they will be connected. However, often there are features which one wants to preserve in the base domain. These features can either be detected automatically or specified by the user.

We consider two types of features on the finest mesh: vertices and paths of edges. Guaranteeing that a certain vertex of the original mesh ends up in the base domain is straightforward. Simply mark that vertex as unremovable throughout the DK hierarchy.

We now describe an algorithm to guarantee that a certain path of edges on the finest mesh gets mapped to an edge of the base domain. Let $\{v_i \mid 1 \leq i \leq I\} \subset \mathcal{K}^L$ be a set of vertices on the finest level which form a path, i.e., $\{v_i, v_{i+1}\}$ is an edge. Tag all the edges in the path as feature edges. First tag v_1 and v_I , so called *dart points* [14], as unremovable so they are guaranteed to end up in the base domain. Let v_i be the first vertex on the interior of the path which gets marked for removal in the DK hierarchy, say, when going from level l to $l-1$. Because of the independent set property, v_{i-1} and v_{i+1} cannot be removed and therefore must belong to \mathcal{K}^{l-1} . When flattening the hole around v_i , tagged edges are treated like a boundary. We first straighten out the edges $\{v_{i-1}, v_i\}$ and

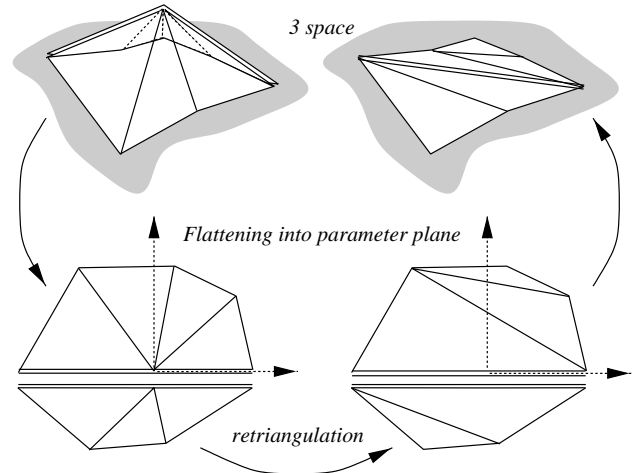

Figure 9: When a vertex with two incident feature edges is removed, we want to ensure that the subsequent retriangulation adds a new feature edge to replace the two old ones.

$\{v_i, v_{i+1}\}$ along the x -axis, and use two boundary type conformal maps to the half disk above and below (cf. the last paragraph of Section 2.4). When retriangulating the hole around v_i , we put the edge $\{v_{i-1}, v_{i+1}\}$ in \mathcal{K}^{l-1} , tag it as a feature edge, and compute a CDT on the upper and lower parts (see Figure 9). If we apply similar procedures on coarser levels, we ensure that v_1 and v_I remain connected by a path (potentially a single edge) on the base domain. This guarantees that Π maps the curved feature path onto the coarsest level edge(s) between v_1 and v_I .

In general, there will be multiple feature paths which may be closed or cross each other. As usual, a vertex with more than 2 incident feature edges is considered a corner, and marked as unremovable.

The feature vertices and paths can be provided by the user or detected automatically. As an example of the latter case, we consider every edge whose dihedral angle is below a certain threshold to be a feature edge, and every vertex whose curvature is above a certain threshold to be a feature vertex. An example of this strategy is illustrated in Figure 13.

3.2 A Quick Review

Before we consider the problem of remeshing, it may be helpful to review what we have at this point. We have established an initial bijection Π of the original surface $\varphi(|\mathcal{K}^L|)$ onto a base domain $\varphi(|\mathcal{K}^0|)$ consisting of a small number of triangles (e.g. Figure 7). We use a simplification hierarchy (Figure 4) in which the holes after vertex removal are flattened and retriangulated (Figures 5 and 9). Original mesh points get successively reparametrized over coarser triangulations (Figure 6). The resulting mapping is always a bijection; triangle flipping (Figure 8) is possible but can be corrected.

4 Remeshing

In this section, we consider remeshing using subdivision connectivity triangulations since it is both a convenient way to illustrate the properties of a parameterization and is an important subject in its own right. In the process, we compute a smoothed version of our initial parameterization. We also show how to efficiently construct an adaptive remeshing with guaranteed error bounds.

4.1 Uniform Remeshing

Since Π is a bijection, we can use Π^{-1} to map the base domain to the original mesh. We follow the strategy used in [7]: regularly (1:4) subdivide the base domain and use the inverse map to obtain a regular connectivity remeshing. This introduces a hierarchy of regular meshes $(\mathcal{Q}^m, \mathcal{R}^m)$ (\mathcal{Q} is the point set and \mathcal{R} is the complex) obtained from m -fold midpoint subdivision of the base domain $(\mathcal{P}^0, \mathcal{K}^0) = (\mathcal{Q}^0, \mathcal{R}^0)$. Midpoint subdivision implies that all new domain points lie in the base domain, $\mathcal{Q}^m \subset \varphi(|\mathcal{R}^0|)$ and $|\mathcal{R}^m| = |\mathcal{R}^0|$. All vertices of $\mathcal{R}^m \setminus \mathcal{R}^0$ have outdegree 6. The uniform remeshing of the original mesh on level m is given by $(\Pi^{-1}(\mathcal{Q}^m), \mathcal{R}^m)$.

We thus need to compute $\Pi^{-1}(q)$ where q is a point in the base domain with dyadic barycentric coordinates. In particular, we need to compute which triangle of $\varphi(|\mathcal{K}^L|)$ contains $\Pi^{-1}(q)$, or, equivalently, which triangle of $\Pi(\varphi(|\mathcal{K}^L|))$ contains q . This is a standard *point location* problem in an irregular triangulation. We use the point location algorithm of Brown and Faigle [2] which avoids looping that can occur with non-Delaunay meshes [10, 9]. Once we have found the triangle $\{i, j, k\}$ which contains q , we can write q as

$$q = \alpha \Pi(p_i) + \beta \Pi(p_j) + \gamma \Pi(p_k),$$

and thus

$$\Pi^{-1}(q) = \alpha p_i + \beta p_j + \gamma p_k \in \varphi(|\mathcal{K}^L|).$$

Figure 10 shows the result of this procedure: a level 3 uniform remeshing of a 3-holed torus using the Π^{-1} map.

A note on complexity: The point location algorithm is essentially a walk on the finest level mesh with complexity $O(\sqrt{N})$. Hierarchical point location algorithms, which have asymptotic complexity $O(\log N)$, exist [15] but have a much larger constant. Given that we schedule the queries in a systematic order, we almost always have an excellent starting guess and observe a constant number of steps. In practice, the finest level “walking” algorithm beats the hierarchical point location algorithms for all meshes we encountered (up to 100K faces).

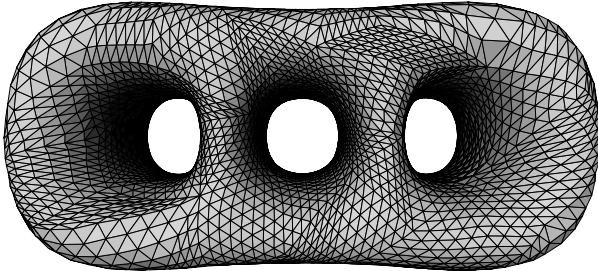

Figure 10: Remeshing of 3 holed torus using midpoint subdivision. The parameterization is smooth within each base domain triangle, but clearly not across base domain triangles.

4.2 Smoothing the Parameterization

It is clear from Figure 10 that the mapping we used is not smooth across global edges. One way to obtain global smoothness is to consider a map that minimizes a global smoothness functional and goes from $\varphi(|\mathcal{K}^L|)$ to $|\mathcal{K}^0|$ rather than to $\varphi(|\mathcal{K}^0|)$. This would require an iterative PDE solver. We have found computation of mappings to topological realizations that live in a high dimensional space to be needlessly cumbersome.

Instead, we use a much simpler and cheaper smoothing technique based on Loop subdivision. The main idea is to compute Π^{-1} at a smoothed version of the dyadic points, rather than at the dyadic points themselves (which can equivalently be viewed as changing the parameterization). To that end, we define a map \mathcal{L} from the base domain to itself by the following modification of Loop:

- If all the points of the stencil needed for computing either a new point or smoothing an old point are inside the same triangle of the base domain, we can simply apply the Loop weights and the new points will be in that same face.
- If the stencil stretches across two faces of the base domain, we flatten them out using a “hinge” map at their common edge. We then compute the point’s position in this flattened domain and extract the triangle in which the point lies together with its barycentric coordinates.
- If the stencil stretches across multiple faces, we use the conformal flattening strategy discussed earlier.

Note that the modifications to Loop force \mathcal{L} to map the base domain onto the base domain. We emphasize that we do *not* apply the classic Loop scheme (which would produce a “blobby” version of the base domain). Nor are the surface approximations that we later produce Loop surfaces.

The composite map $\Pi^{-1} \circ \mathcal{L}$ is our *smoothed parameterization* that maps the base domain onto the original surface. The m -th level of uniform remeshing with the smoothed parameterization is $(\Pi^{-1} \circ \mathcal{L}(Q^m), \mathcal{R}^m)$, where Q^m , as before, are the dyadic points on the base domain. Figure 11 shows the result of this procedure: a level 3 uniform remeshing of a 3-holed torus using the smoothed parameterization.

When the mesh is tagged, we cannot apply smoothing across the tagged edges since this would break the alignment with the features. Therefore, we use modified versions of Loop which can deal with corners, dart points and feature edges [14, 23, 26] (see Figure 13).

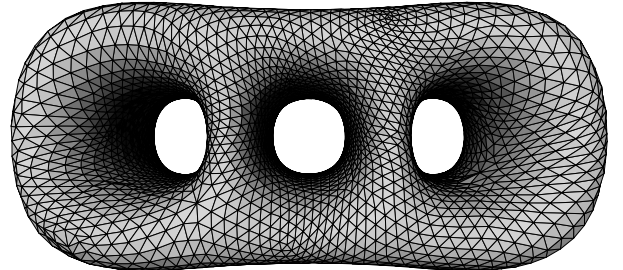

Figure 11: The same remeshing of the 3-holed torus as in Figure 10, but this time with respect to a Loop smoothed parameterization. **Note:** Because the Loop scheme only enters in smoothing the parameterization the surface shown is still a sampling of the original mesh, not a Loop surface approximation of the original.

4.3 Adaptive Remeshing

One of the advantages of meshes with subdivision connectivity is that classical multiresolution and wavelet algorithms can be employed. The standard wavelet algorithms used, e.g., in image compression, start from the finest level, compute the wavelet transform, and then obtain an efficient representation by discarding small wavelet coefficients. Eck et al. [7, 8] as well as Certain et al. [3] follow a similar approach: remesh using a uniformly subdivided grid followed by decimation through wavelet thresholding. This has the drawback that in order to resolve a small local feature on the original mesh, one may need to subdivide to a very fine level. Each extra

level quadruples the number of triangles, most of which will later be decimated using the wavelet procedure. Imagine, e.g., a plane which is coarsely triangulated except for a narrow spike. Making the spike width sufficiently small, the number of levels needed to resolve it can be made arbitrarily high.

In this section we present an algorithm which avoids first building a full tree and later pruning it. Instead, we immediately build the adaptive mesh with a guaranteed conservative error bound. This is possible because the DK hierarchy contains the information on how much subdivision is needed in any given area. Essentially, we let the irregular DK hierarchy “drive” the adaptive construction of the regular pyramid.

We first compute for each triangle $t \in \mathcal{K}^0$ the following error quantity:

$$E(t) = \max_{p_i \in \mathcal{P}^L \text{ and } \Pi(p_i) \in \varphi(|t|)} \text{dist}(p_i, \varphi(|t|)).$$

This measures the distance between one triangle in the base domain and the vertices of the finest level mapped to that triangle.

The adaptive algorithm is now straightforward. Set a certain relative error threshold ϵ . Compute $E(t)$ for all triangles of the base domain. If $E(t)/B$, where B is the largest side of the bounding box, is larger than ϵ , subdivide the domain triangle using the Loop procedure above. Next, we need to reassign vertices to the triangles of level $m = 1$. This is done as follows: For each point $p_i \in \mathcal{P}^L$ consider the triangle t of \mathcal{K}^0 to which it is currently assigned. Next consider the 4 children of t on level 1, t_j with $j = 0, 1, 2, 3$ and compute the distance between p_i and each of the $\varphi(|t_j|)$. Assign p_i to the closest child. Once the finest level vertices have been reassigned to level 1 triangles, the errors for those triangles can be computed. Now iterate this procedure until all triangles have an error below the threshold. Because all errors are computed from the finest level, we are guaranteed to resolve all features within the error bound. Note that we are not computing the true distance between the original vertices and a given approximation, but rather an easy to compute upper bound for it.

In order to be able to compute the Loop smoothing map \mathcal{L} on an adaptively subdivided grid, the grid needs to satisfy a *vertex restriction criterion*, i.e., if a vertex has a triangle incident to it with depth i , then it must have a complete 1-ring at level $i - 1$ [28]. This restriction may necessitate subdividing some triangles even if they are below the error threshold. Examples of adaptive remeshing can be seen in Figure 1 (lower left), Figure 12, and Figure 13.

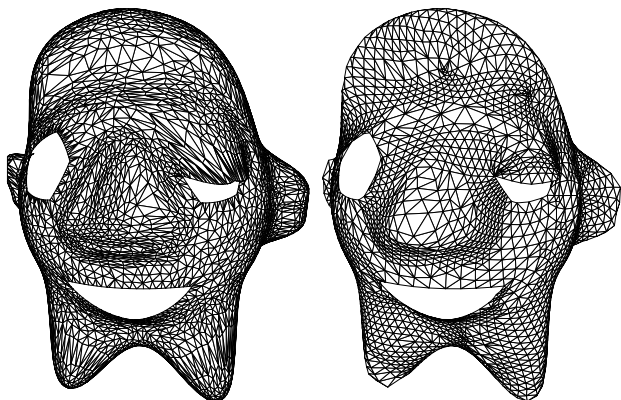

Figure 12: Example remesh of a surface with boundaries.

5 Results

We have implemented MAPS as described above and applied it to a number of well known example datasets, as well as some new

ones. The application was written in C++ using standard computational geometry data structures, see e.g. [21], and all timings reported in this section were measured on a 200 MHz PentiumPro personal computer.

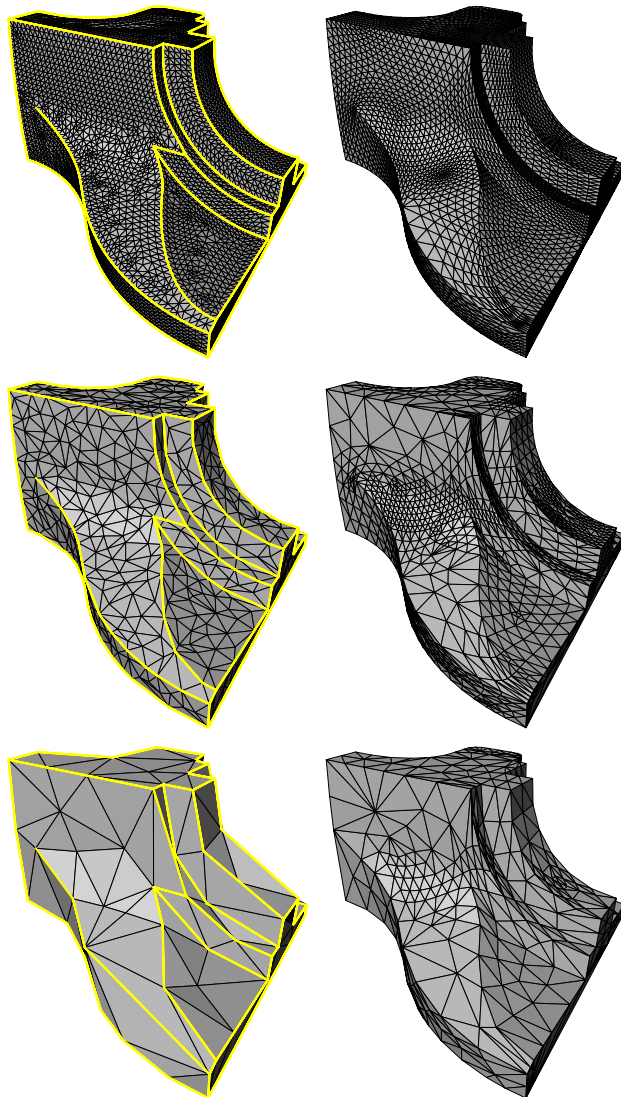

Figure 13: Left (top to bottom): three levels in the DK pyramid, finest ($L = 15$) with 12946, intermediate ($l = 8$) with 1530, and coarsest ($l = 0$) with 168 triangles. Feature edges, dart and corner vertices survive on the base domain. Right (bottom to top): adaptive mesh with $\epsilon = 5\%$ and 1120 triangles (bottom), $\epsilon = 1\%$ and 3430 triangles (middle), and uniform level 3 (top). (Original dataset courtesy University of Washington.)

The first example used throughout the text is the 3-holed torus. The original mesh contained 11776 faces. These were reduced in the DK hierarchy to 120 faces over 14 levels implying an average removal of 30% of the faces on a given level. The remesh of Figure 11 used 4 levels of uniform subdivision for a total of 30720 triangles.

The original sampled geometry of the 3-holed torus is smooth and did not involve any feature constraints. A more challenging case is presented by the fandisk shown in Figure 13. The original mesh (top left) contains 12946 triangles which were reduced to 168

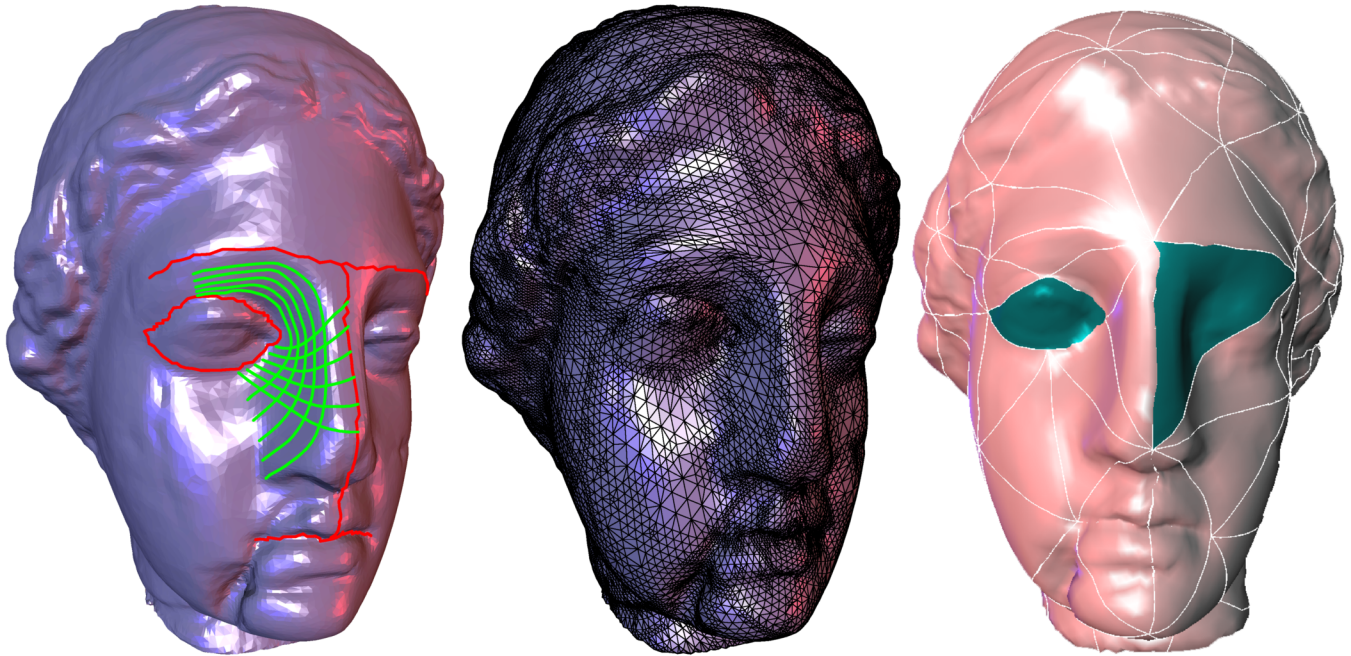

Figure 14: Example of a constrained parameterization based on user input. Top: original input mesh (100000 triangles) with edge tags superimposed in red, green lines show some smooth iso-parameter lines of our parameterization. The middle shows an adaptive subdivision connectivity remesh. The bottom one patches corresponding to the eye regions (right eye was constrained, left eye was not) are highlighted to indicate the resulting alignment of top level patches with the feature lines. (Dataset courtesy Cyberware.)

faces in the base domain over 15 levels (25% average face removal per level). The initial mesh had all edges with dihedral angles below 75° tagged (1487 edges), resulting in 141 tagged edges at the coarsest level. Adaptive remeshing to within $\epsilon = 5\%$ and $\epsilon = 1\%$ (fraction of longest bounding box side) error results in the meshes shown in the right column. The top right image shows a uniform resampling to level 3, in effect showing iso-parameter lines of the parameterization used for remeshing. Note how the iso-parameter lines conform perfectly to the initially tagged features.

This dataset demonstrates one of the advantages of our method— inclusion of feature constraints—over the earlier work of Eck et al. [7]. In the original PM paper [12, Figure 12], Hoppe shows the simplification of the fandisk based on Eck’s algorithm which does not use tagging. He points out that the multiresolution approximation is quite poor at low triangle counts and consequently requires many triangles to achieve high accuracy. The comparison between our Figure 13 and Figure 12 in [12] demonstrates that our multiresolution algorithm which incorporates feature tagging solves these problems.

Another example of constrained parameterization and subsequent adaptive remeshing is shown in Figure 14. The original dataset (100000 triangles) is shown on the left. The red lines indicate user supplied feature constraints which may facilitate subsequent animation. The green lines show some representative iso-parameter lines of our parameterization subject to the red feature constraints. Those can be used for computing texture coordinates. The middle image shows an adaptive subdivision connectivity remesh with 74698 triangles ($\epsilon = 0.5\%$). On the right we have highlighted a group of patches, 2 over the right (constrained) eye and 1 over the left (unconstrained) eye. This indicates how user supplied constraints force domain patches to align with desired features. Other enforced patch boundaries are the eyebrows, center of the nose, and middle of lips (see red lines in left image). This

example illustrates how one places constraints like Krishnamurthy and Levoy [17]. We remove the need in their algorithms to specify the entire base domain. A user may want to control patch outlines for editing in one region (e.g., on the face), but may not care about what happens in other regions (e.g., the back of the head).

We present a final example in Figure 1. The original mesh (96966 triangles) is shown on the top left, with the adaptive, subdivision connectivity remesh on the bottom left. This remesh was subsequently edited in a interactive multiresolution editing system [28] and the result is shown on the bottom middle.

6 Conclusions and Future Research

We have described an algorithm which establishes smooth parameterizations for irregular connectivity, 2-manifold triangular meshes of arbitrary topology. Using a variant of the DK hierarchy construction, we simplify the original mesh and use piecewise linear approximations of conformal mappings to incrementally build a parameterization of the original mesh over a low face count base domain. This parameterization is further improved through a hierarchical smoothing procedure which is based on Loop smoothing in parameter space. The resulting parameterizations are of high quality, and we demonstrated their utility in an adaptive, subdivision connectivity remeshing algorithm that has guaranteed error bounds. The new meshes satisfy the requirements of multiresolution representations which generalize classical wavelet representations and are thus of immediate use in applications such as multiresolution editing and compression. Using edge and vertex constraints, the parameterizations can be forced to respect feature lines of interest without requiring specification of the entire patch network.

In this paper we have chosen remeshing as the primary application to demonstrate the usefulness of the parameterizations we pro-

Dataset	Input size (triangles)	Hierarchy creation	Levels	\mathcal{P}^0 size (triangles)	Remeshing tolerance	Remesh creation	Output size (triangles)
3-hole	11776	18 (s)	14	120	(NA)	8 (s)	30720
fandisk	12946	23 (s)	15	168	1%	10 (s)	3430
fandisk	12946	23 (s)	15	168	5%	5 (s)	1130
head	100000	160 (s)	22	180	0.5%	440 (s)	74698
horse	96966	163 (s)	21	254	1%	60 (s)	15684
horse	96966	163 (s)	21	254	0.5%	314 (s)	63060

Table 1: Selected statistics for the examples discussed in the text. All times are in seconds on a 200 MHz PentiumPro.

duce. The resulting meshes may also find application in numerical analysis algorithms, such as fast multigrid solvers. Clearly there are many other applications which benefit from smooth parameterizations, e.g., texture mapping and morphing, which would be interesting to pursue in future work. Because of its independent set selection the standard DK hierarchy creates topologically uniform simplifications. We have begun to explore how the selection can be controlled using geometric properties. Alternatively, one could use a PM framework to control geometric criteria of simplification. Perhaps the most interesting question for future research is how to incorporate topology changes into the MAPS construction.

Acknowledgments

Aaron Lee and David Dobkin were partially supported by NSF Grant CCR-9643913 and the US Army Research Office Grant DAAH04-96-1-0181. Aaron Lee was also partially supported by a Wu Graduate Fellowship and a Summer Internship at Bell Laboratories, Lucent Technologies. Peter Schröder was partially supported by grants from the Intel Corporation, the Sloan Foundation, an NSF CAREER award (ASC-9624957), a MURI (AFOSR F49620-96-1-0471), and Bell Laboratories, Lucent Technologies. Special thanks to Timothy Baker, Ken Clarkson, Tom Duchamp, Tom Funkhouser, Amanda Galtman, and Ralph Howard for many interesting and stimulation discussions. Special thanks also to Andrei Khodakovsky, Louis Thomas, and Gary Wu for invaluable help in the production of the paper. Our implementation uses the triangle facet data structure and code of Ernst Mücke.

References

- [1] BAJAJ, C. L., BERNADINI, F., CHEN, J., AND SCHIKORE, D. R. Automatic Reconstruction of 3D CAD Models. Tech. Rep. 96-015, Purdue University, February 1996.
- [2] BROWN, P. J. C., AND FAIGLE, C. T. A Robust Efficient Algorithm for Point Location in Triangulations. Tech. rep., Cambridge University, February 1997.
- [3] CERTAIN, A., POPOVIĆ, J., DEROSE, T., DUCHAMP, T., SALESIN, D., AND STUETZLE, W. Interactive Multiresolution Surface Viewing. In *Computer Graphics (SIGGRAPH 96 Proceedings)*, 91–98, 1996.
- [4] COHEN, J., MANOCHA, D., AND OLANO, M. Simplifying Polygonal Models Using Successive Mappings. In *Proceedings IEEE Visualization 97*, 395–402, October 1997.
- [5] DOBKIN, D., AND KIRKPATRICK, D. A Linear Algorithm for Determining the Separation of Convex Polyhedra. *Journal of Algorithms* 6 (1985), 381–392.
- [6] DUCHAMP, T., CERTAIN, A., DEROSE, T., AND STUETZLE, W. Hierarchical Computation of PL harmonic Embeddings. Tech. rep., University of Washington, July 1997.
- [7] ECK, M., DEROSE, T., DUCHAMP, T., HOPPE, H., LOUNSBERY, M., AND STUETZLE, W. Multiresolution Analysis of Arbitrary Meshes. In *Computer Graphics (SIGGRAPH 95 Proceedings)*, 173–182, 1995.
- [8] ECK, M., AND HOPPE, H. Automatic Reconstruction of B-Spline Surfaces of Arbitrary Topological Type. In *Computer Graphics (SIGGRAPH 96 Proceedings)*, 325–334, 1996.
- [9] GARLAND, M., AND HECKBERT, P. S. Fast Polygonal Approximation of Terrains and Height Fields. Tech. Rep. CMU-CS-95-181, CS Dept., Carnegie Mellon U., September 1995.
- [10] GUIBAS, L., AND STOLFI, J. Primitives for the Manipulation of General Subdivisions and the Computation of Voronoi Diagrams. *ACM Transactions on Graphics* 4, 2 (April 1985), 74–123.
- [11] HECKBERT, P. S., AND GARLAND, M. Survey of Polygonal Surface Simplification Algorithms. Tech. rep., Carnegie Mellon University, 1997.
- [12] HOPPE, H. Progressive Meshes. In *Computer Graphics (SIGGRAPH 96 Proceedings)*, 99–108, 1996.
- [13] HOPPE, H. View-Dependent Refinement of Progressive Meshes. In *Computer Graphics (SIGGRAPH 97 Proceedings)*, 189–198, 1997.
- [14] HOPPE, H., DEROSE, T., DUCHAMP, T., HALSTEAD, M., JIN, H., McDONALD, J., SCHWEITZER, J., AND STUETZLE, W. Piecewise Smooth Surface Reconstruction. In *Computer Graphics (SIGGRAPH 94 Proceedings)*, 295–302, 1994.
- [15] KIRKPATRICK, D. Optimal Search in Planar Subdivisions. *SIAM J. Comput.* 12 (1983), 28–35.
- [16] KLEIN, A., CERTAIN, A., DEROSE, T., DUCHAMP, T., AND STUETZLE, W. Vertex-based Delaunay Triangulation of Meshes of Arbitrary Topological Type. Tech. rep., University of Washington, July 1997.
- [17] KRISHNAMURTHY, V., AND LEVOY, M. Fitting Smooth Surfaces to Dense Polygon Meshes. In *Computer Graphics (SIGGRAPH 96 Proceedings)*, 313–324, 1996.
- [18] LOOP, C. Smooth Subdivision Surfaces Based on Triangles. Master’s thesis, University of Utah, Department of Mathematics, 1987.
- [19] LOUNSBERY, M. *Multiresolution Analysis for Surfaces of Arbitrary Topological Type*. PhD thesis, Department of Computer Science, University of Washington, 1994.
- [20] LOUNSBERY, M., DEROSE, T., AND WARREN, J. Multiresolution Analysis for Surfaces of Arbitrary Topological Type. *Transactions on Graphics* 16, 1 (January 1997), 34–73.
- [21] MÜCKE, E. P. Shapes and Implementations in Three-Dimensional Geometry. Technical Report UIUCDCS-R-93-1836, University of Illinois at Urbana-Champaign, 1993.
- [22] SCHRÖDER, P., AND SWELDENS, W. Spherical Wavelets: Efficiently Representing Functions on the Sphere. In *Computer Graphics (SIGGRAPH 95 Proceedings)*, Annual Conference Series, 1995.
- [23] SCHWEITZER, J. E. *Analysis and Application of Subdivision Surfaces*. PhD thesis, University of Washington, 1996.
- [24] SPANIER, E. H. *Algebraic Topology*. McGraw-Hill, New York, 1966.
- [25] XIA, J. C., AND VARSHNEY, A. Dynamic View-Dependent Simplification for Polygonal Models. In *Proceedings Visualization 96*, 327–334, October 1996.
- [26] ZORIN, D. *Subdivision and Multiresolution Surface Representations*. PhD thesis, California Institute of Technology, 1997.
- [27] ZORIN, D., SCHRÖDER, P., AND SWELDENS, W. Interpolating Subdivision for Meshes with Arbitrary Topology. In *Computer Graphics (SIGGRAPH 96 Proceedings)*, 189–192, 1996.
- [28] ZORIN, D., SCHRÖDER, P., AND SWELDENS, W. Interactive Multiresolution Mesh Editing. In *Computer Graphics (SIGGRAPH 97 Proceedings)*, 259–268, 1997.

Chapter 10

Subdivision Surfaces in the Making of Geri's Game

Speaker: Tony DeRose

Subdivision Surfaces in Character Animation

Tony DeRose

Michael Kass

Tien Truong

Pixar Animation Studios



Figure 1: Geri.

Abstract

The creation of believable and endearing characters in computer graphics presents a number of technical challenges, including the modeling, animation and rendering of complex shapes such as heads, hands, and clothing. Traditionally, these shapes have been modeled with NURBS surfaces despite the severe topological restrictions that NURBS impose. In order to move beyond these restrictions, we have recently introduced subdivision surfaces into our production environment. Subdivision surfaces are not new, but their use in high-end CG production has been limited.

Here we describe a series of developments that were required in order for subdivision surfaces to meet the demands of high-end production. First, we devised a practical technique for construct-

ing provably smooth variable-radius fillets and blends. Second, we developed methods for using subdivision surfaces in clothing simulation including a new algorithm for efficient collision detection. Third, we developed a method for constructing smooth scalar fields on subdivision surfaces, thereby enabling the use of a wider class of programmable shaders. These developments, which were used extensively in our recently completed short film *Geri's game*, have become a highly valued feature of our production environment.

CR Categories: I.3.5 [Computer Graphics]: Computational Geometry and Object Modeling; I.3.3 [Computer Graphics]: Picture/Image Generation.

1 Motivation

The most common way to model complex smooth surfaces such as those encountered in human character animation is by using a patchwork of trimmed NURBS. Trimmed NURBS are used primarily because they are readily available in existing commercial systems such as Alias-Wavefront and SoftImage. They do, however, suffer from at least two difficulties:

1. Trimming is expensive and prone to numerical error.
2. It is difficult to maintain smoothness, or even approximate smoothness, at the seams of the patchwork as the model is

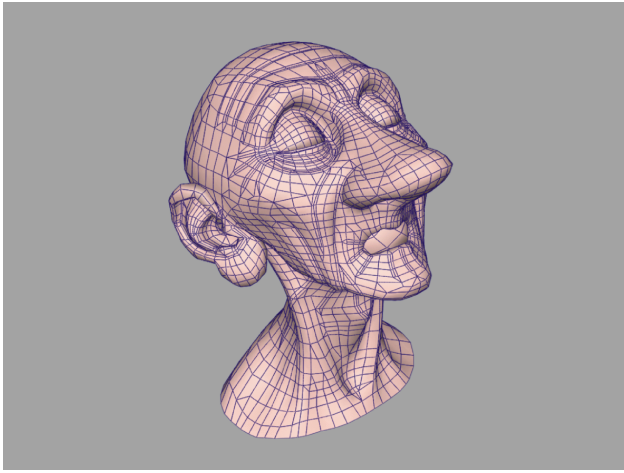

Figure 2: The control mesh for Geri's head, created by digitizing a full-scale model sculpted out of clay.

animated. As a case in point, considerable manual effort was required to hide the seams in the face of Woody, a principal character in *Toy Story*.

Subdivision surfaces have the potential to overcome both of these problems: they do not require trimming, and smoothness of the model is automatically guaranteed, even as the model animates.

The use of subdivision in animation systems is not new, but for a variety of reasons (several of which we address in this paper), their use has not been widespread. In the mid 1980s for instance, Symbolics was possibly the first to use subdivision in their animation system as a means of creating detailed polyhedra. The LightWave 3D modeling and animation system from NewTek also uses subdivision in a similar fashion.

This paper describes a number of issues that arose when we added a variant of Catmull-Clark [2] subdivision surfaces to our animation and rendering systems, Marionette and RenderMan [17], respectively. The resulting extensions were used heavily in the creation of Geri (Figure 1), a human character in our recently completed short film *Geri's game*. Specifically, subdivision surfaces were used to model the skin of Geri's head (see Figure 2), his hands, and his clothing, including his jacket, pants, shirt, tie, and shoes.

In contrast to previous systems such as those mentioned above, that use subdivision as a means to embellish polygonal models, our system uses subdivision as a means to define piecewise smooth surfaces. Since our system reasons about the limit surface itself, polygonal artifacts are never present, no matter how the surface animates or how closely it is viewed.

The use of subdivision surfaces posed new challenges throughout the production process, from modeling and animation to rendering. In modeling, subdivision surfaces free the designer from worrying about the topological restrictions that haunt NURBS modelers, but they simultaneously prevent the use of special tools that have been developed over the years to add features such as variable radius fillets to NURBS models. In Section 3, we describe an approach for introducing similar capabilities into subdivision surface models. The basic idea is to generalize the infinitely sharp creases of Hoppe *et al.* [10] to obtain semi-sharp creases – that is, creases whose sharpness can vary from zero (meaning smooth) to infinite.

Once models have been constructed with subdivision surfaces, the problems of animation are generally easier than with corresponding NURBS surfaces because subdivision surface models are seamless, so the surface is guaranteed to remain smooth as the model is animated. Using subdivision surfaces for physically-based

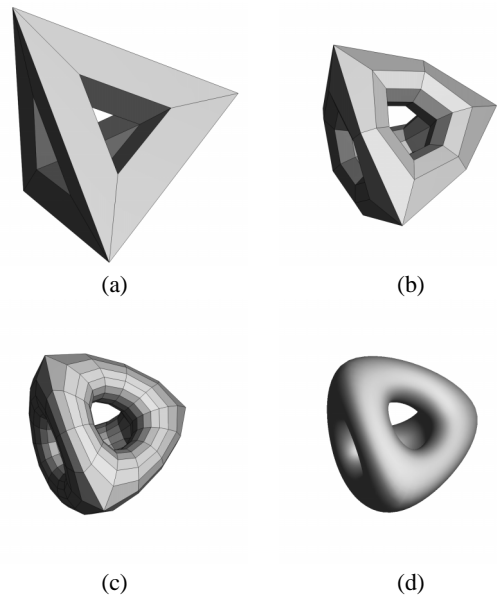

Figure 3: Recursive subdivision of a topologically complicated mesh: (a) the control mesh; (b) after one subdivision step; (c) after two subdivision steps; (d) the limit surface.

animation of clothing, however, poses its own difficulties which we address in Section 4. First, it is necessary to express the energy function of the clothing on subdivision meshes in such a way that the resulting motion does not inappropriately reveal the structure of the subdivision control mesh. Second, in order for a physical simulator to make use of subdivision surfaces it must compute collisions very efficiently. While collisions of NURBS surfaces have been studied in great detail, little work has been done previously with subdivision surfaces.

Having modeled and animated subdivision surfaces, some formidable challenges remain before they can be rendered. The topological freedom that makes subdivision surfaces so attractive for modeling and animation means that they generally do not admit parametrizations suitable for texture mapping. Solid textures [12, 13] and projection textures [9] can address some production needs, but Section 5.1 shows that it is possible to go a good deal further by using programmable shaders in combination with smooth scalar fields defined over the surface.

The combination of semi-sharp creases for modeling, an appropriate and efficient interface to physical simulation for animation, and the availability of scalar fields for shading and rendering have made subdivision surfaces an extremely effective tool in our production environment.

2 Background

A single NURBS surface, like any other parametric surface, is limited to representing surfaces which are topologically equivalent to a sheet, a cylinder or a torus. This is a fundamental limitation for any surface that imposes a global planar parameterization. A single subdivision surface, by contrast, can represent surfaces of arbitrary topology. The basic idea is to construct a surface from an arbitrary polyhedron by repeatedly subdividing each of the faces, as illustrated in Figure 3. If the subdivision is done appropriately, the limit of this subdivision process will be a smooth surface.

Catmull and Clark [2] introduced one of the first subdivision schemes. Their method begins with an arbitrary polyhedron called

the control mesh. The control mesh, denoted M^0 (see Figure 3(a)), is subdivided to produce the mesh M^1 (shown in Figure 3(b)) by splitting each face into a collection of quadrilateral subfaces. A face having n edges is split into n quadrilaterals. The vertices of M^1 are computed using certain weighted averages as detailed below. The same subdivision procedure is used again on M^1 to produce the mesh M^2 shown in Figure 3(c). The subdivision surface is defined to be the limit of the sequence of meshes M^0, M^1, \dots created by repeated application of the subdivision procedure.

To describe the weighted averages used by Catmull and Clark it is convenient to observe that each vertex of M^{i+1} can be associated with either a face, an edge, or a vertex of M^i ; these are called face, edge, and vertex points, respectively. This association is indicated in Figure 4 for the situation around a vertex v^0 of M^0 . As indicated in the figure, we use f 's to denote face points, e 's to denote edge points, and v 's to denote vertex points. Face points are positioned at the centroid of the vertices of the corresponding face. An edge point e_j^{i+1} , as indicated in Figure 4 is computed as

$$e_j^{i+1} = \frac{v^i + e_j^i + f_{j-1}^{i+1} + f_j^{i+1}}{4}, \quad (1)$$

where subscripts are taken modulo the valence of the central vertex v^0 . (The valence of a vertex is the number of edges incident to it.) Finally, a vertex point v^i is computed as

$$v^{i+1} = \frac{n-2}{n}v^i + \frac{1}{n^2} \sum_j e_j^i + \frac{1}{n^2} \sum_j f_j^{i+1} \quad (2)$$

Vertices of valence 4 are called ordinary; others are called extraordinary.

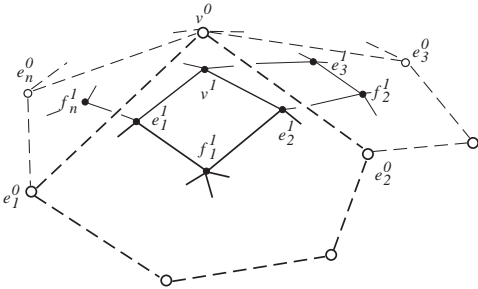

Figure 4: The situation around a vertex v^0 of valence n .

These averaging rules — also called subdivision rules, masks, or stencils — are such that the limit surface can be shown to be tangent plane smooth no matter where the control vertices are placed [14, 19].¹

Whereas Catmull-Clark subdivision is based on quadrilaterals, Loop's surfaces [11] and the Butterfly scheme [6] are based on triangles. We chose to base our work on Catmull-Clark surfaces for two reasons:

1. They strictly generalize uniform tensor product cubic B-splines, making them easier to use in conjunction with existing in-house and commercial software systems such as Alias-Wavefront and SoftImage.
2. Quadrilaterals are often better than triangles at capturing the symmetries of natural and man-made objects. Tube-like surfaces — such as arms, legs, and fingers — for example, can be modeled much more naturally with quadrilaterals.

¹Technical caveat for the purist: The surface is guaranteed to be smooth except for control vertex positions in a set of measure zero.



Figure 5: Geri's hand as a piecewise smooth Catmull-Clark surface. Infinitely sharp creases are used between the skin and the fingernails.

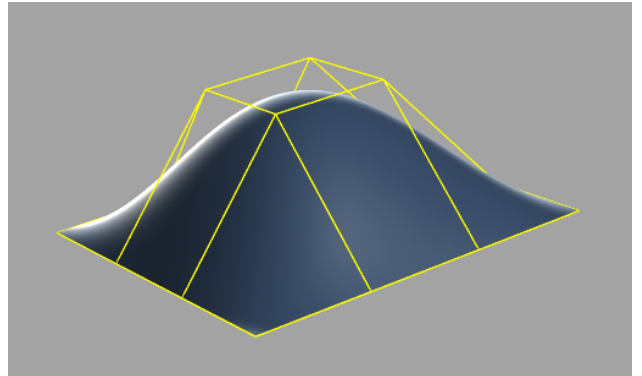

Figure 6: A surface where boundary edges are tagged as sharp and boundary vertices of valence two are tagged as corners. The control mesh is yellow and the limit surface is cyan.

Following Hoppe *et. al.* [10] it is possible to modify the subdivision rules to create piecewise smooth surfaces containing infinitely sharp features such as creases and corners. This is illustrated in Figure 5 which shows a close-up shot of Geri's hand. Infinitely sharp creases were used to separate the skin of the hand from the fingernails. Sharp creases can be modeled by marking a subset of the edges of the control mesh as sharp and then using specially designed rules in the neighborhood of sharp edges. Appendix A describes the necessary special rules and when to use them.

Again following Hoppe *et. al.*, we deal with boundaries of the control mesh by tagging the boundary edges as sharp. We have also found it convenient to tag boundary vertices of valence 2 as corners, even though they would normally be treated as crease vertices since they are incident to two sharp edges. We do this to mimic the behavior of endpoint interpolating tensor product uniform cubic B-spline surfaces, as illustrated in Figure 6.

3 Modeling fillets and blends

As mentioned in Section 1 and shown in Figure 5, infinitely sharp creases are very convenient for representing piecewise-smooth surfaces. However, real-world surfaces are never infinitely sharp. The corner of a tabletop, for instance, is smooth when viewed sufficiently closely. For animation purposes it is often desirable to capture such tightly curved shapes.

To this end we have developed a generalization of the Catmull-

Clark scheme to admit semi-sharp creases – that is, creases of controllable sharpness, a simple example of which is shown in Figure 7.

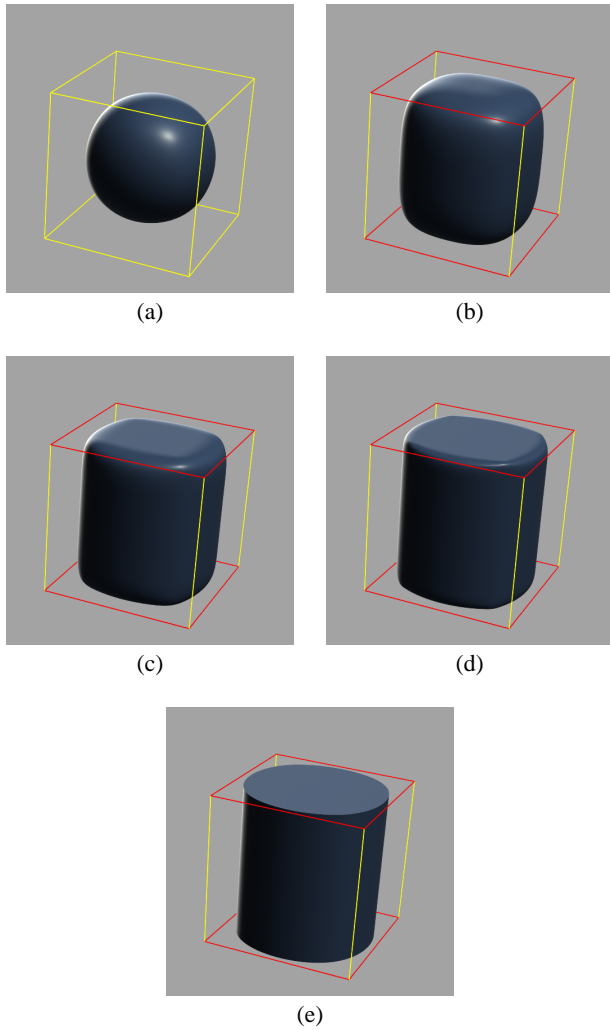

Figure 7: An example of a semi-sharp crease. The control mesh for each of these surfaces is the unit cube, drawn in wireframe, where crease edges are red and smooth edges are yellow. In (a) the crease sharpness is 0, meaning that all edges are smooth. The sharpnesses for (b), (c), (d), and (e) are 1, 2, 3, and infinite, respectively.

One approach to achieve semi-sharp creases is to develop subdivision rules whose weights are parametrized by the sharpness s of the crease. This approach is difficult because it can be quite hard to discover rules that lead to the desired smoothness properties of the limit surfaces. One of the roadblocks is that subdivision rules around a crease break a symmetry possessed by the smooth rules: typical smooth rules (such as the Catmull-Clark rules) are invariant under cyclic reindexing, meaning that discrete Fourier transforms can be used to prove properties for vertices of arbitrary valence (cf. Zorin [19]). In the absence of this invariance, each valence must currently be considered separately, as was done by Schweitzer [15]. Another difficulty is that such an approach is likely to lead to a zoo of rules depending on the number and configuration of creases through a vertex. For instance, a vertex with two semi-sharp creases passing through it would use a different set of rules than a vertex with just one crease through it.

Our approach is to use a very simple process we call hybrid subdivision. The general idea is to use one set of rules for a finite but

arbitrary number of subdivision steps, followed by another set of rules that are applied to the limit. Smoothness therefore depends only on the second set of rules. Hybrid subdivision can be used to obtain semi-sharp creases by using infinitely sharp rules during the first few subdivision steps, followed by use of the smooth rules for subsequent subdivision steps. Intuitively this leads to surfaces that are sharp at coarse scales, but smooth at finer scales.

Now the details. To set the stage for the general situation where the sharpness can vary along a crease, we consider two illustrative special cases.

Case 1: A constant integer sharpness s crease: We subdivide s times using the infinitely sharp rules, then switch to the smooth rules. In other words, an edge of sharpness $s > 0$ is subdivided using the sharp edge rule. The two subedges created each have sharpness $s - 1$. A sharpness $s = 0$ edge is considered smooth, and it stays smooth for remaining subdivisions. In the limit where $s \rightarrow \infty$ the sharp rules are used for all steps, leading to an infinitely sharp crease. An example of integer sharpness creases is shown in Figure 7. A more complicated example where two creases of different sharpnesses intersect is shown in Figure 8.

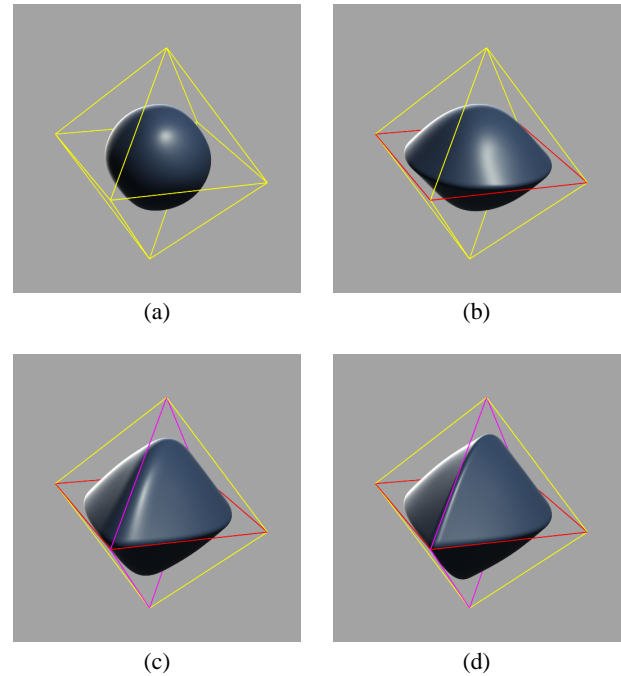

Figure 8: A pair of crossing semi-sharp creases. The control mesh for all surfaces is the octahedron drawn in wire frame. Yellow denotes smooth edges, red denotes the edges of the first crease, and magenta denotes the edges of the second crease. In (a) the crease sharpnesses are both zero; in (b), (c), and (d) the sharpness of the red crease is 4. The sharpness of the magenta crease in (b), (c), and (d) is 0, 2, and 4, respectively.

Case 2: A constant, but not necessarily integer sharpness s : the main idea here is to interpolate between adjacent integer sharpnesses. Let $\lfloor s \rfloor$ and $\lceil s \rceil$ denote the floor and ceiling of s , respectively. Imagine creating two versions of the crease: the first obtained by subdividing $\lfloor s \rfloor$ times using the sharp rules, then subdividing one additional time using the smooth rules. Call the vertices of this first version v_0, v_1, \dots . The second version, the vertices of which we denote by v'_0, v'_1, \dots , is created by subdividing $\lceil s \rceil$ times using the sharp rules. We take the $\lceil s \rceil$ -times subdivided semi-sharp crease to

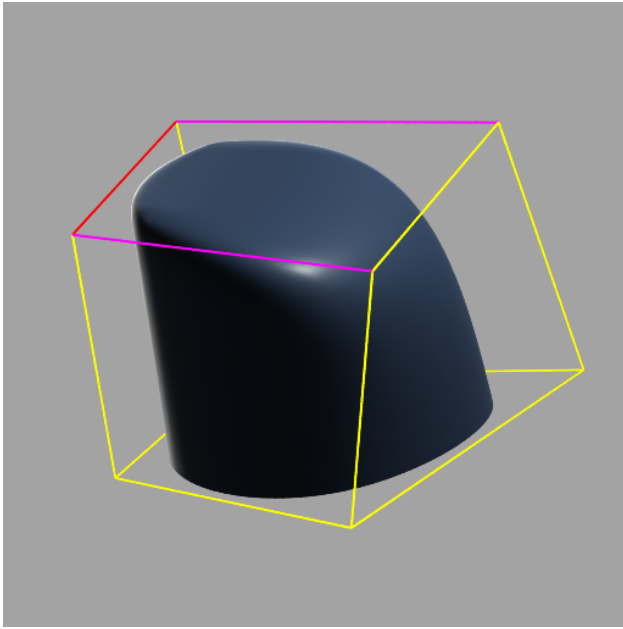

Figure 9: A simple example of a variable sharpness crease. The edges of the bottom face of the cubical control mesh are infinitely sharp. Three edges of the top face form a single variable sharpness crease with edge sharpnesses set to 2 (the two magenta edges), and 4 (the red edge).

have vertex positions $v_i^{s\uparrow}$ computed via simple linear interpolation:

$$v_i^{s\uparrow} = (1 - \sigma)v_i + \sigma v_i^{\uparrow} \quad (3)$$

where $\sigma = (s - s\downarrow)/(s\uparrow - s\downarrow)$. Subsequent subdivisions are done using the smooth rules. In the case where all creases have the same non-integer sharpness s , the surface produced by the above process is identical to the one obtained by linearly interpolating between the integer sharpness limit surfaces corresponding to $s\downarrow$ and $s\uparrow$. Typically, however, crease sharpnesses will not all be equal, meaning that the limit surface is not a simple blend of integer sharpness surfaces.

The more general situation where crease sharpness is non-integer and varies along a crease is presented in Appendix B. Figure 9 depicts a simple example. A more complex use of variable sharpness is shown in Figure 10.

4 Supporting cloth dynamics

The use of simulated physics to animate clothing has been widely discussed in the literature (cf. [1, 5, 16]). Here, we address the issues that arise when interfacing a physical simulator to a set of geometric models constructed out of subdivision surfaces. It is not our intent in this section to detail our cloth simulation system fully – that would require an entire paper of its own. Our goal is rather to highlight issues related to the use of subdivision surfaces to model both kinematic and dynamic objects.

In Section 4.1 we define the behavior of the cloth material by constructing an energy functional on the subdivision control mesh. If the material properties such as the stiffness of the cloth vary over the surface, one or more scalar fields (see Section 5.1) must be defined to modulate the local energy contributions. In Section 4.2 we describe an algorithm for rapidly identifying potential collisions involving the cloth and/or kinematic obstacles. Rapid collision detection is crucial to achieving acceptable performance.



Figure 10: A more complex example of variable sharpness creases. This model, inspired by an Edouard Lanteri sculpture, contains numerous variable sharpness creases to reduce the size of the control mesh. The control mesh for the model made without variable sharpness creases required 840 faces; with variable sharpness creases the face count dropped to 627. Model courtesy of Jason Bickerstaff.

4.1 Energy functional

For physical simulation, the basic properties of a material are generally specified by defining an energy functional to represent the attraction or resistance of the material to various possible deformations. Typically, the energy is either specified as a surface integral or as a discrete sum of terms which are functions of the positions of surface samples or control vertices. The first type of specification typically gives rise to a finite-element approach, while the second is associated more with finite-difference methods.

Finite-element approaches are possible with subdivision surfaces, and in fact some relevant surface integrals can be computed analytically [8]. In general, however, finite-element surface integrals must be estimated through numerical quadrature, and this gives rise to a collection of special cases around extraordinary points. We chose to avoid these special cases by adopting a finite-difference approach, approximating the clothing with a mass-spring model [18] in which all the mass is concentrated at the control points.

Away from extraordinary points, Catmull-Clark meshes under subdivision become regular quadrilateral grids. This makes them ideally suited for representing woven fabrics which are also generally described locally by a gridded structure. In constructing the energy functions for clothing simulation, we use the edges of the subdivision mesh to correspond with the warp and weft directions of the simulated woven fabrics.

Since most popular fabrics stretch very little along the warp or weft directions, we introduce relatively strong fixed rest-length springs along each edge of the mesh. More precisely, for each edge from p_1 to p_2 , we add an energy term $k_s E_s(p_1, p_2)$ where

$$E_s(p_1, p_2) = \frac{1}{2} \left(\frac{|p_1 - p_2|}{|p_1^* - p_2^*|} - 1 \right)^2 \quad (4)$$

Here, p_1^* and p_2^* are the rest positions of the two vertices, and k_s is

the corresponding spring constant.

With only fixed-length springs along the mesh edges, the simulated clothing can undergo arbitrary skew without penalty. One way to prevent the skew is to introduce fixed-length springs along the diagonals. The problem with this approach is that strong diagonal springs make the mesh too stiff, and weak diagonal springs allow the mesh to skew excessively. We chose to address this problem by introducing an energy term which is proportional to the product of the energies of two diagonal fixed-length springs. If p_1 and p_2 are vertices along one diagonal of a quadrilateral mesh face and p_3 and p_4 are vertices along the other diagonal, the energy is given by $k_d E_d(p_1, p_2, p_3, p_4)$ where k_d is a scalar parameter that functions analogously to a spring constant, and where

$$E_d(p_1, p_2, p_3, p_4) = E_s(p_1, p_2)E_s(p_3, p_4). \quad (5)$$

The energy $E_d(p_1, p_2, p_3, p_4)$ reaches its minimum at zero when either of the diagonals of the quadrilateral face are of the original rest length. Thus the material can fold freely along either diagonal, while resisting skew to a degree determined by k_d . We sometimes use weak springs along the diagonals to keep the material from wrinkling too much.

With the fixed-length springs along the edges and the diagonal contributions to the energy, the simulated material, unlike real cloth, can bend without penalty. To add greater realism to the simulated cloth, we introduce an energy term that establishes a resistance to bending along virtual threads. Virtual threads are defined as a sequence of vertices. They follow grid lines in regular regions of the mesh, and when a thread passes through an extraordinary vertex of valence n , it continues by exiting along the edge $\lfloor n/2 \rfloor$ -edges away in the clockwise direction. If p_1, p_2 , and p_3 are three points along a virtual thread, the anti-bending component of the energy is given by $k_p E_p(p_1, p_2, p_3)$ where

$$E_p(p_1, p_2, p_3) = \frac{1}{2} * [C(p_1, p_2, p_3) - C(p_1^*, p_2^*, p_3^*)]^2 \quad (6)$$

$$C(p_1, p_2, p_3) = \left| \frac{p_3 - p_2}{|p_3^* - p_2^*|} - \frac{p_2 - p_1}{|p_2^* - p_1^*|} \right| \quad (7)$$

and p_1^*, p_2^* , and p_3^* are the rest positions of the three points.

By adjusting k_s , k_d and k_p both globally and locally, we have been able to simulate a reasonably wide variety of cloth behavior. In the production of *Geri's game*, we found that Geri's jacket looked a great deal more realistic when we modulated k_p over the surface of the jacket in order to provide more stiffness on the shoulder pads, on the lapels, and in an area under the armpits which is often reinforced in real jackets. Methods for specifying scalar fields like k_p over a subdivision surface are discussed in more detail in section 5.1.

4.2 Collisions

The simplest approach to detecting collisions in a physical simulation is to test each geometric element (i.e. point, edge, face) against each other geometric element for a possible collision. With N geometric elements, this would take N^2 time, which is prohibitive for large N . To achieve practical running times for large simulations, the number of possible collisions must be culled as rapidly as possible using some type of spatial data structure. While this can be done in a variety of different ways, there are two basic strategies: we can distribute the elements into a two-dimensional surface-based data structure, or we can distribute them into a three-dimensional volume-based data structure. Using a two-dimensional structure has several advantages if the surface connectivity does not change. First, the hierarchy can be fixed, and need not be regenerated each time the geometry is moved. Second, the storage can all be statically allocated. Third, there is never any need to rebalance the tree.

Finally, very short edges in the surface need not give rise to deep branches in the tree, as they would using a volume-based method.

It is a simple matter to construct a suitable surface-based data structure for a NURBS surface. One method is to subdivide the (s, t) parameter plane recursively into an quadtree. Since each node in the quadtree represents a subsquare of the parameter plane, a bounding box for the surface restricted to the subsquare can be constructed. An efficient method for constructing the hierarchy of boxes is to compute bounding boxes for the children using the convex hull property; parent bounding boxes can then be computed in a bottom up fashion by unioning child boxes. Having constructed the quadtree, we can find all patches within ϵ of a point p as follows. We start at the root of the quadtree and compare the bounding box of the root node with a box of size 2ϵ centered on p . If there is no intersection, then there are no patches within ϵ of p . If there is an intersection, then we repeat the test on each of the children and recurse. The recursion terminates at the leaf nodes of the quadtree, where bounding boxes of individual subpatches are tested against the box around p .

Subdivision meshes have a natural hierarchy for levels finer than the original unsubdivided mesh, but this hierarchy is insufficient because even the unsubdivided mesh may have too many faces to test exhaustively. Since there is no global (s, t) plane from which to derive a hierarchy, we instead construct a hierarchy by "unsubdividing" or "coarsening" the mesh: We begin by forming leaf nodes of the hierarchy, each of which corresponds to a face of the subdivision surface control mesh. We then hierarchically merge faces level by level until we finish with a single merged face corresponding to the entire subdivision surface.

The process of merging faces proceeds as follows. In order to create the ℓ th level in the hierarchy, we first mark all non-boundary edges in the $\ell - 1$ st level as candidates for merging. Then until all candidates at the ℓ th level have been exhausted, we pick a candidate edge e , and remove it from the mesh, thereby creating a "superface" f^* by merging the two faces f_1 and f_2 that shared e . The hierarchy is extended by creating a new node to represent f^* and making its children be the nodes corresponding to f_1 and f_2 . If f^* were to participate immediately in another merge, the hierarchy could become poorly balanced. To ensure against that possibility, we next remove all edges of f^* from the candidate list. When all the candidate edges at one level have been exhausted, we begin the next level by marking non-boundary edges as candidates once again. Hierarchy construction halts when only a single superface remains in the mesh.

The coarsening hierarchy is constructed once in a preprocessing phase. During each iteration of the simulation, control vertex positions change, so the bounding boxes stored in the hierarchy must be updated. Updating the boxes is again a bottom up process: the current control vertex positions are used to update the bounding boxes at the leaves of the hierarchy. We do this efficiently by storing with each leaf in the hierarchy a set of pointers to the vertices used to construct its bounding box. Bounding boxes are then unioned up the hierarchy. A point can be "tested against" a hierarchy to find all faces within ϵ of the point by starting at the root of the hierarchy and recursively testing bounding boxes, just as is done with the NURBS quadtree.

We build a coarsening hierarchy for each of the cloth meshes, as well as for each of the kinematic obstacles. To determine collisions between a cloth mesh and a kinematic obstacle, we test each vertex of the cloth mesh against the hierarchy for the obstacle. To determine collisions between a cloth mesh and itself, we test each vertex of the mesh against the hierarchy for the same mesh.

5 Rendering subdivision surfaces

In this section, we introduce the idea of smoothly varying scalar fields defined over subdivision surfaces and show how they can be used to apply parametric textures to subdivision surfaces. We then describe a collection of implementation issues that arose when subdivision surfaces and scalar fields were added to RenderMan.

5.1 Texturing using scalar fields

NURBS surfaces are textured using four principal methods: parametric texture mapping, procedural texture, 3D paint [9], and solid texture [12, 13]. It is straightforward to apply 3D paint and solid texturing to virtually any type of primitive, so these techniques can readily be applied to texture subdivision surfaces. It is less clear, however, how to apply parametric texture mapping, and more generally, procedural texturing to subdivision surfaces since, unlike NURBS, they are not defined parametrically.

With regard to texture mapping, subdivision surfaces are more akin to polygonal models since neither possesses a global (s, t) parameter plane. The now-standard method of texture mapping a polygonal model is to assign texture coordinates to each of the vertices. If the faces of the polygon consist only of triangles and quadrilaterals, the texture coordinates can be interpolated across the face of the polygon during scan conversion using linear or bilinear interpolation. Faces with more than four sides pose a greater challenge. One approach is to pre-process the model by splitting such faces into a collection of triangles and/or quadrilaterals, using some averaging scheme to invent texture coordinates at newly introduced vertices. One difficulty with this approach is that the texture coordinates are not differentiable across edges of the original or pre-processed mesh. As illustrated in Figures 11(a) and (b), these discontinuities can appear as visual artifacts in the texture, especially as the model is animated.

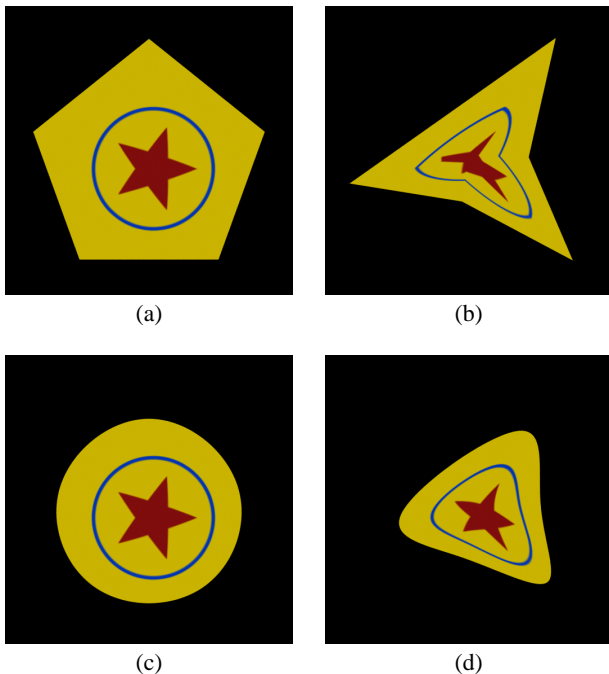

Figure 11: (a) A texture mapped regular pentagon comprised of 5 triangles; (b) the pentagonal model with its vertices moved; (c) A subdivision surface whose control mesh is the same 5 triangles in (a), and where boundary edges are marked as creases; (d) the subdivision surface with its vertices positioned as in (b).

Fortunately, the situation for subdivision surfaces is profoundly better than for polygonal models. As we prove in Appendix C, smoothly varying texture coordinates result if the texture coordinates (s, t) assigned to the control vertices are subdivided using the same subdivision rules as used for the geometric coordinates (x, y, z) . (In other words, control point positions and subdivision can be thought of as taking place in a 5-space consisting of (x, y, z, s, t) coordinates.) This is illustrated in Figure 11(c), where the surface is treated as a Catmull-Clark surface with infinitely sharp boundary edges. A more complicated example of parametric texture on a subdivision surface is shown in Figure 12.

As is generally the case in real productions, we used a combination of texturing methods to create Geri: the flesh tones on his head and hands were 3D-painted, solid textures were used to add fine detail to his skin and jacket, and we used procedural texturing (described more fully below) for the seams of his jacket.

The texture coordinates s and t mentioned above are each instances of a scalar field; that is, a scalar-valued function that varies over the surface. A scalar field f is defined on the surface by assigning a value f_v to each of the control vertices v . The proof sketch in Appendix C shows that the function $f(p)$ created through subdivision (where p is a point on the limit surface) varies smoothly wherever the subdivision surface itself is smooth.

Scalar fields can be used for more than just parametric texture mapping — they can be used more generally as arbitrary parameters to procedural shaders. An example of this occurs on Geri's jacket. A scalar field is defined on the jacket that takes on large values for points on the surface near a seam, and small values elsewhere. The procedural jacket shader uses the value of the this field to add the apparent seams to the jacket. We use other scalar fields to darken Geri's nostril and ear cavities, and to modulate various physical parameters of the cloth in the cloth simulator.

We assign scalar field values to the vertices of the control mesh in a variety of ways, including direct manual assignment. In some cases, we find it convenient to specify the value of the field directly at a small number of control points, and then determine the rest by interpolation using Laplacian smoothing. In other cases, we specify the scalar field values by painting an intensity map on one or more rendered images of the surface. We then use a least squares solver to determine the field values that best reproduce the painted intensities.

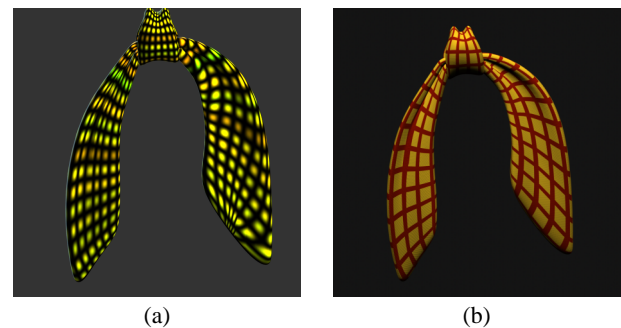

Figure 12: Gridded textures mapped onto a bandanna modeled using two subdivision surfaces. One surface is used for the knot, the other for the two flaps. In (a) texture coordinates are assigned uniformly on the right flap and nonuniformly using smoothing on the left to reduce distortion. In (b) smoothing is used on both sides and a more realistic texture is applied.

5.2 Implementation issues

We have implemented subdivision surfaces, specifically semi-sharp Catmull-Clark surfaces, as a new geometric primitive in RenderMan.

Our renderer, built upon the REYES architecture [4], demands that all primitives be convertible into grids of micropolygons (i.e. half-pixel wide quadrilaterals). Consequently, each type of primitive must be capable of splitting itself into a collection of subpatches, bounding itself (for culling and bucketing purposes), and dicing itself into a grid of micropolygons.

Each face of a Catmull-Clark control mesh can be associated with a patch on the surface, so the first step in rendering a Catmull-Clark surface is to split it into a collection of individual patches. The control mesh for each patch consists of a face of the control mesh together with neighboring faces and their vertices. To bound each patch, we use the knowledge that a Catmull-Clark surface lies within the convex hull of its control mesh. We therefore take the bounding box of the mesh points to be the bounding box for the patch. Once bounded, the primitive is tested to determine if it is diceable; it is not diceable if dicing would produce a grid with too many micropolygons or a wide range of micropolygon sizes. If the patch is not diceable, then we split each patch by performing a subdivision step to create four new subpatch primitives. If the patch is diceable, it is repeatedly subdivided until it generates a grid with the required number of micropolygons. Finally, we move each of the grid points to its limit position using the method described in Halstead *et. al.* [8].

An important property of Catmull-Clark surfaces is that they give rise to bicubic B-spline patches for all faces except those in the neighborhood of extraordinary points or sharp features. Therefore, at each level of splitting, it is often possible to identify one or more subpatches as B-spline patches. As splitting proceeds, more of the surface can be covered with B-spline patches. Exploiting this fact has three advantages. First, the fixed 4×4 size of a B-spline patch allows for efficiency in memory usage because there is no need to store information about vertex connectivity. Second, the fact that a B-spline patch, unlike a Catmull-Clark patch, can be split independently in either parametric direction makes it possible to reduce the total amount of splitting. Third, efficient and well understood forward differencing algorithms are available to dice B-spline patches [7].

We quickly learned that an advantage of semi-sharp creases over infinitely sharp creases is that the former gives smoothly varying normals across the crease, while the latter does not. This implies that if the surface is displaced in the normal direction in a creased area, it will tear at an infinitely sharp crease but not at a semi-sharp one.

6 Conclusion

Our experience using subdivision surfaces in production has been extremely positive. The use of subdivision surfaces allows our model builders to arrange control points in a way that is natural to capture geometric features of the model (see Figure 2), without concern for maintaining a regular gridded structure as required by NURBS models. This freedom has two principal consequences. First, it dramatically reduces the time needed to plan and build an initial model. Second, and perhaps more importantly, it allows the initial model to be refined locally. Local refinement is not possible with a NURBS surface, since an entire control point row, or column, or both must be added to preserve the gridded structure. Additionally, extreme care must be taken either to hide the seams between NURBS patches, or to constrain control points near the seam to create at least the illusion of smoothness.

By developing semi-sharp creases and scalar fields for shading,

we have removed two of the important obstacles to the use of subdivision surfaces in production. By developing an efficient data structure for culling collisions with subdivisions, we have made subdivision surfaces well suited to physical simulation. By developing a cloth energy function that takes advantage of Catmull-Clark mesh structure, we have made subdivision surfaces the surfaces of choice for our clothing simulations. Finally, by introducing Catmull-Clark subdivision surfaces into our RenderMan implementation, we have shown that subdivision surfaces are capable of meeting the demands of high-end rendering.

A Infinitely Sharp Creases

Hoppe *et. al.* [10] introduced infinitely sharp features such as creases and corners into Loop's surfaces by modifying the subdivision rules in the neighborhood of a sharp feature. The same can be done for Catmull-Clark surfaces, as we now describe.

Face points are always positioned at face centroids, independent of which edges are tagged as sharp. Referring to Figure 4, suppose the edge $v^i e_j^i$ has been tagged as sharp. The corresponding edge point is placed at the edge midpoint:

$$e_j^{i+1} = \frac{v^i + e_j^i}{2}. \quad (8)$$

The rule to use when placing vertex points depends on the number of sharp edges incident at the vertex. A vertex with one sharp edge is called a dart and is placed using the smooth vertex rule from Equation 2. A vertex v^i with two incident sharp edges is called a crease vertex. If these sharp edges are $e_j^i v^i$ and $v^i e_k^i$, the vertex point v^{i+1} is positioned using the crease vertex rule:

$$v^{i+1} = \frac{e_j^i + 6v^i + e_k^i}{8}. \quad (9)$$

The sharp edge and crease vertex rules are such that an isolated crease converges to a uniform cubic B-spline curve lying on the limit surface. A vertex v^i with three or more incident sharp edges is called a corner; the corresponding vertex point is positioned using the corner rule

$$v^{i+1} = v^i \quad (10)$$

meaning that corners do not move during subdivision. See Hoppe *et. al.* [10] and Schweitzer [15] for a more complete discussion and rationale for these choices.

Hoppe *et. al.* found it necessary in proving smoothness properties of the limit surfaces in their Loop-based scheme to make further distinctions between so-called regular and irregular vertices, and they introduced additional rules to subdivide them. It may be necessary to do something similar to prove smoothness of our Catmull-Clark based method, but empirically we have noticed no anomalies using the simple strategy above.

B General semi-sharp creases

Here we consider the general case where a crease sharpness is allowed to be non-integer, and to vary along the crease. The following procedure is relatively simple and strictly generalizes the two special cases discussed in Section 3.

We specify a crease by a sequence of edges e_1, e_2, \dots in the control mesh, where each edge e_i has an associated sharpness $e_i.s$. We associate a sharpness per edge rather than one per vertex since there is no single sharpness that can be assigned to a vertex where two or more creases cross.²

²In our implementation we do not allow two creases to share an edge.

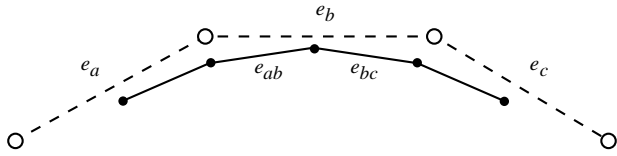

Figure 13: Subedge labeling.

During subdivision, face points are always placed at face centroids. The rules used when placing edge and vertex points are determined by examining edge sharpnesses as follows:

- An edge point corresponding to a smooth edge (i.e. $e.s = 0$) is computed using the smooth edge rule (Equation 1).
- An edge point corresponding to an edge of sharpness $e.s \geq 1$ is computed using the sharp edge rule (Equation 8).
- An edge point corresponding to an edge of sharpness $e.s < 1$ is computed using a blend between smooth and sharp edge rules: specifically, let v_{smooth} and v_{sharp} be the edge points computed using the smooth and sharp edge rules, respectively. The edge point is placed at

$$(1 - e.s)v_{smooth} + e.sv_{sharp}. \quad (11)$$

- A vertex point corresponding to a vertex adjacent to zero or one sharp edges is computed using the smooth vertex rule (Equation 2).
- A vertex point corresponding to a vertex v adjacent to three or more sharp edge is computed using the corner rule (Equation 10).
- A vertex point corresponding to a vertex v adjacent to two sharp edges is computed using the crease vertex rule (Equation 9) if $v.s \geq 1$, or a linear blend between the crease vertex and corner masks if $v.s < 1$, where $v.s$ is the average of the incidence edge sharpnesses.

When a crease edge is subdivided, the sharpnesses of the resulting subedges is determined using Chaikin's curve subdivision algorithm [3]. Specifically, if e_a, e_b, e_c denote three adjacent edges of a crease, then the subedges e_{ab} and e_{bc} as shown in Figure 13 have sharpnesses

$$e_{ab}.s = \max\left(\frac{e_a.s + 3e_b.s}{4} - 1, 0\right)$$

$$e_{bc}.s = \max\left(\frac{3e_b.s + e_c.s}{4} - 1, 0\right)$$

A 1 is subtracted after performing Chaikin's averaging to account for the fact that the subedges (e_{ab}, e_{bc}) are at a finer level than their parent edges (e_a, e_b, e_c). A maximum with zero is taken to keep the sharpnesses non-negative. If either e_a or e_b is infinitely sharp, then e_{ab} is; if either e_b or e_c is infinitely sharp, then e_{bc} is. This relatively simple procedure generalizes cases 1 and 2 described in Section 3. Examples are shown in Figures 9 and 10.

C Smoothness of scalar fields

In this appendix we wish to sketch a proof that a scalar field f is smooth as a function on a subdivision surface wherever the surface itself is smooth. To say that a function on a smooth surface S is smooth to first order at a point p on the surface is to say that there

exists a parametrization $S(s, t)$ for the surface in the neighborhood of p such that $S(0, 0) = p$, and such that the function $f(s, t)$ is differentiable and the derivative varies continuously in the neighborhood of $(0, 0)$.

The characteristic map, introduced by Reif [14] and extended by Zorin [19], provides such a parametrization: the characteristic map allows a subdivision surface S in three space in the neighborhood of a point p on the surface to be written as

$$S(s, t) = (x(s, t), y(s, t), z(s, t)) \quad (12)$$

where $S(0, 0) = p$ and where each of $x(s, t)$, $y(s, t)$, and $z(s, t)$ is once differentiable if the surface is smooth at p . Since scalar fields are subdivided according to the same rules as the x, y , and z coordinates of the control points, the function $f(s, t)$ must also be smooth.

Acknowledgments

The authors would like to thank Ed Catmull for creating the *Geri's game* project, Jan Pinkava for creating Geri and for writing and directing the film, Karen Dufilho for producing it, Dave Haumann and Leo Hourvitz for leading the technical crew, Paul Aichele for building Geri's head, Jason Bickerstaff for modeling most of the rest of Geri and for Figure 10, and Guido Quaroni for Figure 12. Finally, we'd like to thank the entire crew of *Geri's game* for making our work look so good.

References

- [1] David E. Breen, Donald H. House, and Michael J. Wozny. Predicting the drape of woven cloth using interacting particles. In Andrew Glassner, editor, *Proceedings of SIGGRAPH '94 (Orlando, Florida, July 24–29, 1994)*, Computer Graphics Proceedings, Annual Conference Series, pages 365–372. ACM SIGGRAPH, ACM Press, July 1994. ISBN 0-89791-667-0.
- [2] E. Catmull and J. Clark. Recursively generated B-spline surfaces on arbitrary topological meshes. *Computer Aided Design*, 10(6):350–355, 1978.
- [3] G. Chaikin. An algorithm for high speed curve generation. *Computer Graphics and Image Processing*, 3:346–349, 1974.
- [4] Robert L. Cook, Loren Carpenter, and Edwin Catmull. The Reyes image rendering architecture. In Maureen C. Stone, editor, *Computer Graphics (SIGGRAPH '87 Proceedings)*, pages 95–102, July 1987.
- [5] Martin Courshesnes, Pascal Volino, and Nadia Magnenat Thalmann. Versatile and efficient techniques for simulating cloth and other deformable objects. In Robert Cook, editor, *SIGGRAPH 95 Conference Proceedings*, Annual Conference Series, pages 137–144. ACM SIGGRAPH, Addison Wesley, August 1995. held in Los Angeles, California, 06-11 August 1995.
- [6] Nira Dyn, David Leven, and John Gregory. A butterfly subdivision scheme for surface interpolation with tension control. *ACM Transactions on Graphics*, 9(2):160–169, April 1990.
- [7] James D. Foley, Andries van Dam, Steven K. Feiner, and John F. Hughes. *Computer Graphics: Principles and Practice*. Prentice-Hall, 1990.
- [8] Mark Halstead, Michael Kass, and Tony DeRose. Efficient, fair interpolation using Catmull-Clark surfaces. *Computer Graphics*, 27(3):35–44, August 1993.

- [9] Pat Hanrahan and Paul E. Haeberli. Direct WYSIWYG painting and texturing on 3D shapes. In Forest Baskett, editor, *Computer Graphics (SIGGRAPH '90 Proceedings)*, volume 24, pages 215–223, August 1990.
- [10] H. Hoppe, T. DeRose, T. Duchamp, M. Halstead, H. Jin, J. McDonald, J. Schweitzer, and W. Stuetzle. Piecewise smooth surface reconstruction. *Computer Graphics*, 28(3):295–302, July 1994.
- [11] Charles T. Loop. Smooth subdivision surfaces based on triangles. Master's thesis, Department of Mathematics, University of Utah, August 1987.
- [12] Darwyn R. Peachey. Solid texturing of complex surfaces. In B. A. Barsky, editor, *Computer Graphics (SIGGRAPH '85 Proceedings)*, volume 19, pages 279–286, July 1985.
- [13] Ken Perlin. An image synthesizer. In B. A. Barsky, editor, *Computer Graphics (SIGGRAPH '85 Proceedings)*, volume 19, pages 287–296, July 1985.
- [14] Ulrich Reif. A unified approach to subdivision algorithms. Mathematisches Institute A 92-16, Universitaet Stuttgart, 1992.
- [15] Jean E. Schweitzer. *Analysis and Application of Subdivision Surfaces*. PhD thesis, Department of Computer Science and Engineering, University of Washington, 1996.
- [16] Demetri Terzopoulos, John Platt, Alan Barr, and Kurt Fleischer. Elastically deformable models. In Maureen C. Stone, editor, *Computer Graphics (SIGGRAPH '87 Proceedings)*, volume 21, pages 205–214, July 1987.
- [17] Steve Upstill. *The RenderMan Companion*. Addison-Wesley, 1990.
- [18] Andrew Witkin, David Baraff, and Michael Kass. An introduction to physically based modeling. SIGGRAPH Course Notes, Course No. 32, 1994.
- [19] Denis Zorin. *Stationary Subdivision and Multiresolution Surface Representations*. PhD thesis, Caltech, Pasadena, 1997.

